

Small Magnetic Ring Communication Common Mode Choke Coil- ACSR Series

Operating Temp. : -50°C ~+150°C

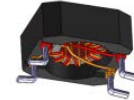

FEATURES

- The circular type, small size and low profile
- Suppression of common mode noise at high frequency
- Excellent mechanical
- AEC-Q200 verified

APPLICATIONS

- Date and signal line

PRODUCT IDENTIFICATION

ACSR ①	0906 ②	S ③	510 ④	N ⑤	T ⑥																		
<table border="1"> <tr><th colspan="2">Type</th></tr> <tr><td>ACSR</td><td>Common Mode Ring Core for Automotive Signal Line</td></tr> </table>		Type		ACSR	Common Mode Ring Core for Automotive Signal Line	<table border="1"> <tr><th colspan="2">External Dimensions (LxW) (mm)</th></tr> <tr><td>0906</td><td>9.0x6.0</td></tr> </table>		External Dimensions (LxW) (mm)		0906	9.0x6.0	<table border="1"> <tr><th colspan="2">Feature Type</th></tr> <tr><td>S</td><td>Sector Winding</td></tr> <tr><td>C</td><td>Bifilar Winding</td></tr> </table>		Feature Type		S	Sector Winding	C	Bifilar Winding				
Type																							
ACSR	Common Mode Ring Core for Automotive Signal Line																						
External Dimensions (LxW) (mm)																							
0906	9.0x6.0																						
Feature Type																							
S	Sector Winding																						
C	Bifilar Winding																						
<table border="1"> <tr><th colspan="2">Nominal Inductance</th></tr> <tr><th>Example</th><th>Nominal Value</th></tr> <tr><td>250</td><td>25μH</td></tr> <tr><td>510</td><td>51μH</td></tr> <tr><td>101</td><td>100μH</td></tr> </table>		Nominal Inductance		Example	Nominal Value	250	25μH	510	51μH	101	100μH	<table border="1"> <tr><th colspan="2">Tolerance Limits</th></tr> <tr><td>N</td><td>±30%</td></tr> </table>		Tolerance Limits		N	±30%	<table border="1"> <tr><th colspan="2">Packing</th></tr> <tr><td>T</td><td>Tape & Reel</td></tr> </table>		Packing		T	Tape & Reel
Nominal Inductance																							
Example	Nominal Value																						
250	25μH																						
510	51μH																						
101	100μH																						
Tolerance Limits																							
N	±30%																						
Packing																							
T	Tape & Reel																						

SHAPE AND DIMENSIONS

ACSR0906 TYPE

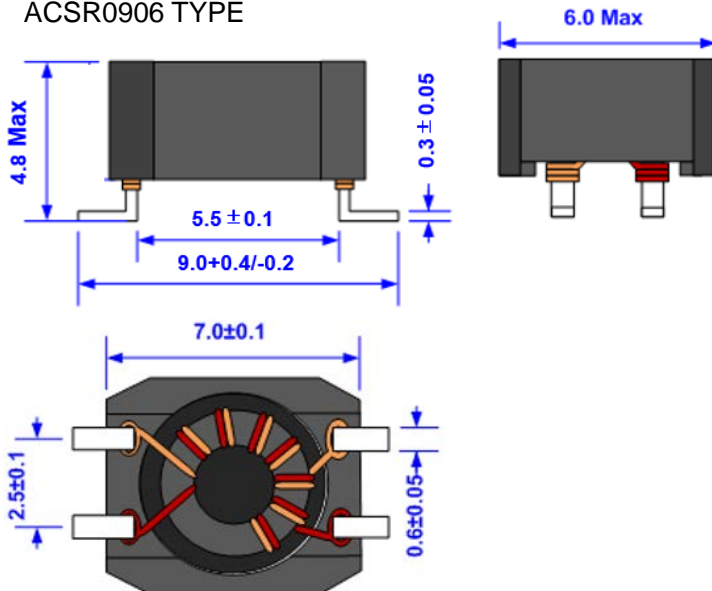

Recommended Land Pattern

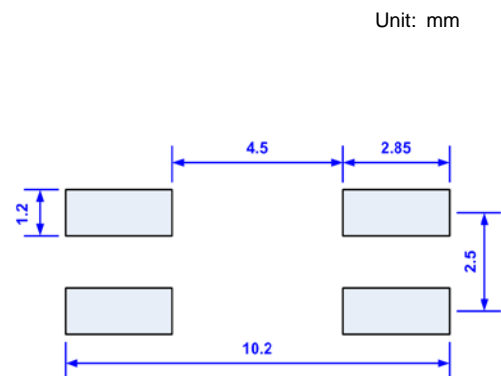

SPECIFICATIONS

ACSR0906 TYPE

Part Number	Inductance (μH)	Stray Inductance (nH) Typ.	DCR (Ω) Max.	Rated Current (mA) Max.	V _{test} (V _{DC} /2sec)	Inductance Tolerance	Operation Temperature Range (°C)
ACSR0906C050NT	5 @100KHz/0.1mA	40 @1MHz/5mA	0.06	1200	250	±30%	-50~+150
ACSR0906C110NT	11 @100KHz/0.1mA	50 @1MHz/5mA	0.08	800	250	±30%	-50~+150
ACSR0906C250NT	25 @100KHz/0.1mA	60 @100K Hz/5mA	0.11	800	250	±30%	-50~+150
ACSR0906S250NT	25 @100KHz/0.1mA	1400 @100KHz/5mA	0.11	800	250	±30%	-50~+150
ACSR0906C510NT	51 @100KHz/0.1mA	70 @100KHz/5mA	0.14	800	250	±30%	-50~+150
ACSR0906S510NT	51 @100KHz/0.1mA	2300 @100KHz/5mA	0.14	800	250	±30%	-50~+150
ACSR0906C101NT	100 @100KHz/0.1mA	100 @100KHz/5mA	0.18	500	250	±30%	-50~+150
ACSR0906C471NT	470 @100KHz/0.1mA	100 @100KHz/5mA	0.17	700	750	±30%	-40~+125
ACSR0906C102NT	1000 @100KHz/0.1mA	70 @100KHz/5mA	0.14	700	750	-30%/+50%	-40~+125
ACSR0906C222NT	2200 @10KHz/0.1mA	120 @100KHz/5mA	0.4	500	750	-30%/+50%	-40~+125
ACSR0906C472NT	4700 @10KHz/0.1mA	250 @100KHz/5mA	0.55	400	750	-30%/+50%	-40~+125

1.Storage Temperature Range (packaging conditions): -10°C~+40°C and RH 70% (Max.)

2.Rated Voltage:42V_{AC} (50/60Hz) / 80V_{DC}

※: Products with other electrical characteristics can be provided upon customer's request. Please contact your local sales.

EQUIVALENT CIRCUIT

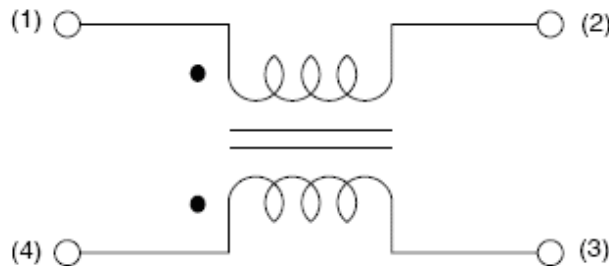

TYPICAL ELECTRICAL CHARACTERISTICS

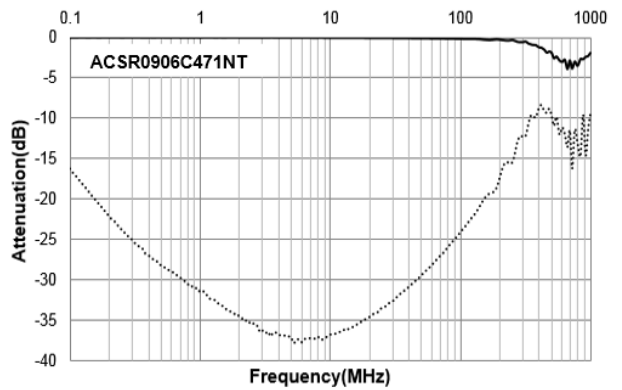
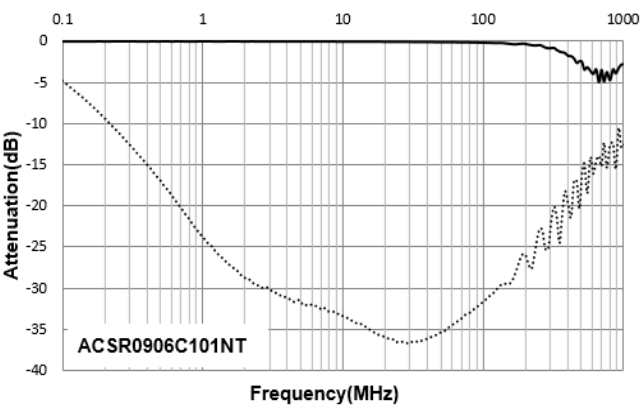
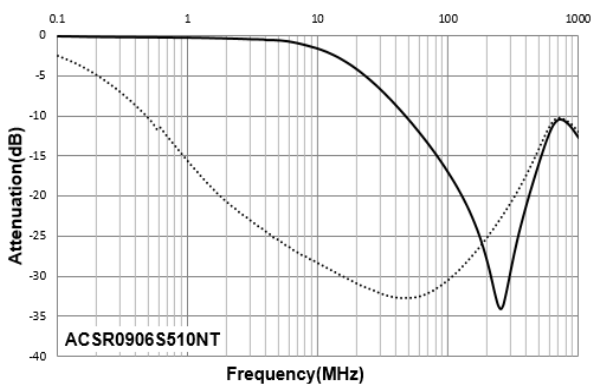
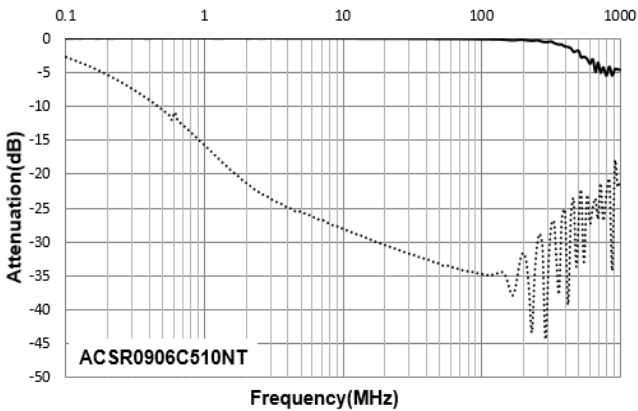
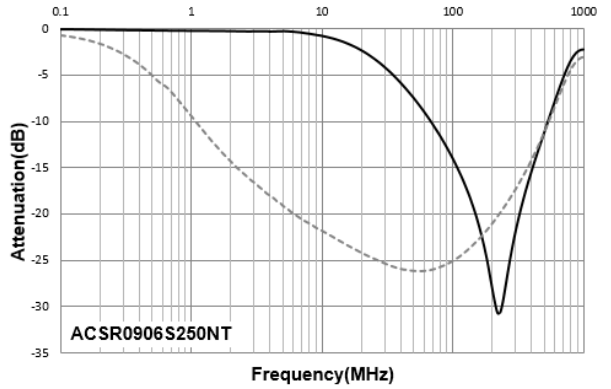
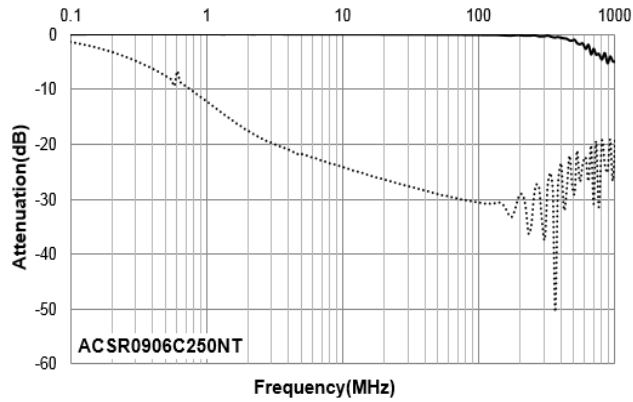
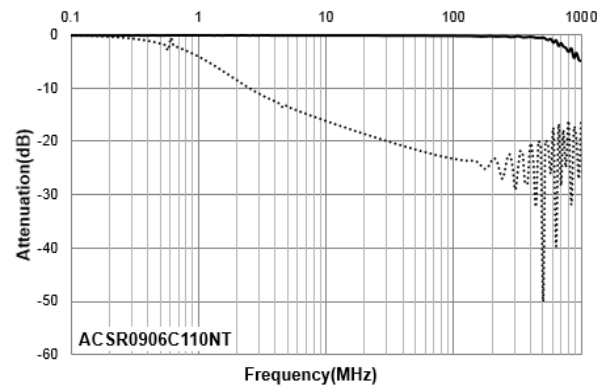
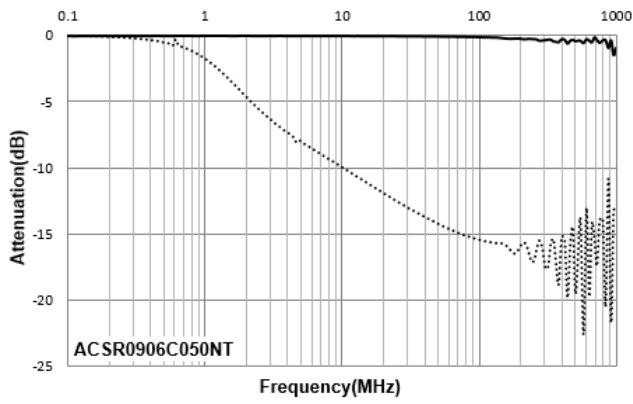

TYPICAL ELECTRICAL CHARACTERISTICS

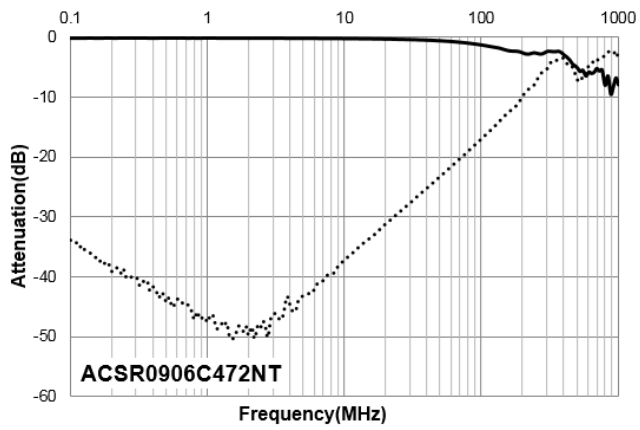
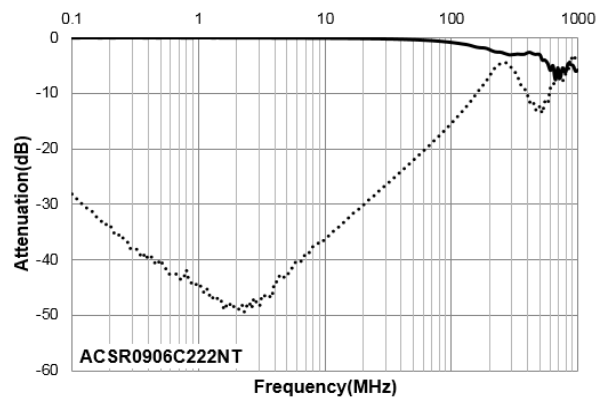
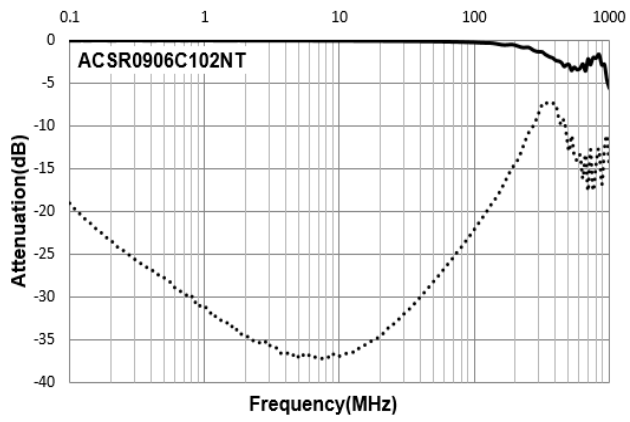

X-ON Electronics

Largest Supplier of Electrical and Electronic Components

Click to view similar products for [Common Mode Chokes / Filters](#) category:

Click to view products by [Sunlord](#) manufacturer:

Other Similar products are found below :

[74279408](#) [PE-62911NL](#) [PE-64683](#) [RD5122-6-9M6](#) [RGCMF1210900H3T](#) [ST6118T-R](#) [FE3X025-10-7NL](#) [T8114NLT](#) [RD5122-10-6M0](#)
[TCM0806G-350-2P-T](#) [TCM0806G-650-2P-T](#) [IND-0110](#) [UAL21VR0802000](#) [UALSC023000000](#) [UALSC1020JH000](#) [UALSC1520JH000](#)
[UALSU10VR15019](#) [UALSU9VD070100](#) [36-00037](#) [5701610000](#) [UALW21HS200290](#) [UALW21HS072450](#) [UALSU9HF050500](#)
[UALSU9H0208000](#) [UAL24VK06450CH](#) [PLT10HH501100PNB](#) [PLT10HH401100PNB](#) [PLT10HH1026R0PNB](#) [PE-67531](#) [TLH10UB 113](#)
[OR5](#) [2752045447](#) [CMS3-11-R](#) [7351V](#) [7408-RC](#) [CMF16-153131](#) [744252510](#) [T8116NLT](#) [CMS2-10-R](#) [DLW44SN101SK2L](#) [FE2X10-4-2NL](#)
[744253200](#) [744253101](#) [744252220](#) [TX8111NLT](#) [UAL30VR3500470](#) [CTX01-19077-R](#) [T8003NLT](#) [CTX01-13663](#) [CTX66-19521-R](#)
[7446630047](#)