

SPECIFICATIONS

Customer	天河星
Product Name	Multi-layer Chip Ferrite Bead
Sunlord Part Number	GZ3216D101TF
Customer Part Number	

New Released, Revised]

SPEC No.: **GZ10190032**

【This SPEC is total 10 pages including specifications and appendix.】

【ROHS Compliant Parts】

Approved By	Checked By	Issued By
		

Shenzhen Sunlord Electronics Co., Ltd.

Address: Sunlord Industrial Park, Dafuyuan Industrial Zone, Guanlan, Shenzhen, China 518110
 Tel: 0086-755-29832660 Fax: 0086-755-82269029 E-Mail: sunlord@sunlordinc.com

【For Customer approval Only】

Date: _____

Qualification Status: Full Restricted Rejected

Approved By	Verified By	Re-checked By	Checked By

Comments:

【Version change history】

Rev.	Effective Date	Changed Contents	Change Reasons	Approved By
01	Mar.04,2019	New release	/	Hai Guo

Caution

All products listed in this specification are developed, designed and intended for use in general electronics equipment. The products are not designed or warranted to meet the requirements of the applications listed below, whose performance and/or quality require especially high reliability, or whose failure, malfunction or trouble might directly cause damage to society, person, or property. Please understand that we are not responsible for any damage or liability caused by use of the products in any of the applications below. Please contact us for more details if you intend to use our products in the following applications.

1. Aircraft equipment
2. Aerospace equipment
3. Undersea equipment
4. nuclear control equipment
5. military equipment
6. Power plant equipment
7. Medical equipment
8. Transportation equipment (automobiles, trains, ships, etc.)
9. Traffic signal equipment
10. Disaster prevention / crime prevention equipment
11. Data-processing equipment
12. Applications of similar complexity or with reliability requirements comparable to the applications listed in the above

1. Scope

This specification applies to GZ3216D101TF of multi-layer ferrite chip bead.

2. Product Description and Identification (Part Number)

- 1) Description:
GZ3216D101TF of multi-layer ferrite chip bead.
- 2) Product Identification (Part Number)

GZ 3216 D 101 I F
 ① ② ③ ④ ⑤ ⑥

①	Type
GZ	For General Use

②	External Dimensions (L X W)[mm]
3216 [1206]	3.2 X 1.6

③	Material Code
D	

⑤	Packing
T	Tape Carrier Package

④	Nominal Impedance
Example	Nominal Value
101	100Ω

⑥	HSF Products
Hazardous Substance Free Products	

3. Electrical Characteristics

Part Number	Impedance (Ω)	Z Test Freq. (MHz)	DCR (Ω) Max.	I _r (mA) Max.
GZ3216D101TF	100±25%	100	0.10	1000

Impedance Frequency Characteristics

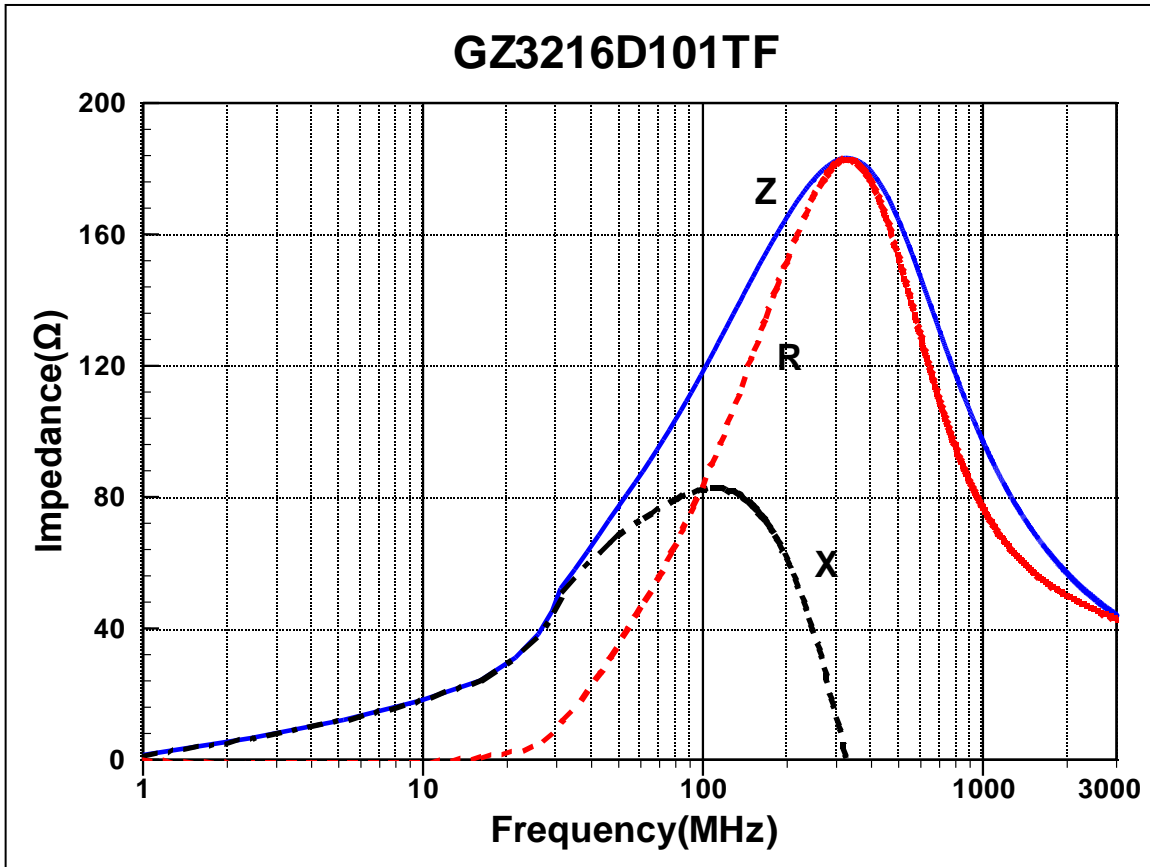

- 1) Operating and storage temperature range (individual chip without packing): -55°C ~ +125°C.
- 2) Storage temperature range (packaging conditions): -10°C ~ +40°C and RH 70% (Max.)

4. Shape and Dimensions

- 1) Dimensions and recommended PCB pattern for reflow soldering: See Fig.4-1, Fig.4-2 and Table 4-1.
- 2) Structure: See Fig. 4-3 and Fig. 4-4.

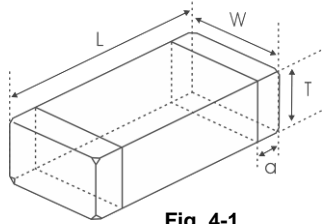

Fig. 4-1

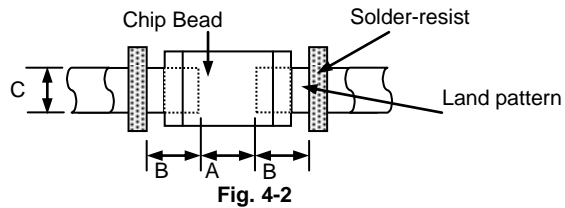

Fig. 4-2

[Table 4-1]

Unit: mm [inch]

Type	L	W	T	a	A	B	C
3216 [1206]	3.2±0.2 [0.126±0.008]	1.6±0.2 [0.063±0.008]	0.85±0.2 [0.033±0.008]	0.5±0.3 [0.020±0.012]	1.80~2.50	1.00~1.50	1.20~2.00

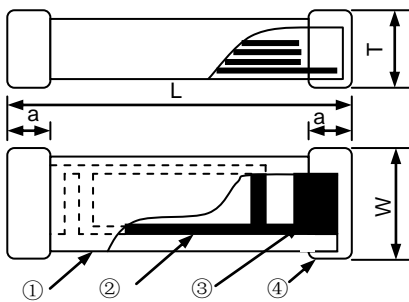

Fig. 4-3

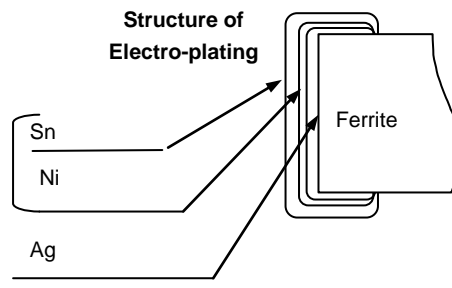

Fig. 4-4

- ① Ferrite for Bead Series
- ② Internal electrode (Ag)
- ③ Pull out electrode (Ag)
- ④-1 Terminal electrode: Inside (Ag)
- ④-2 Outside (Electro-plating Ni-Sn)

- 3) Material Information: See Table 4-2.

[Table 4-2]

Code	Part Name	Material Name
①	Ferrite Body	Ferrite Powder
②	Inner Coils	Silver Paste
③	Pull-out Electrode (Ag)	Silver Paste
④-1	Terminal Electrode: Inside Ag	Termination Silver Composition
④-2	Electro-Plating: Ni/Sn plating	Plating Chemicals

5. Test and Measurement Procedures

5.1 Test Conditions

5.1.1 Unless otherwise specified, the standard atmospheric conditions for measurement/test as:

- a. Ambient Temperature: 20±15°C
- b. Relative Humidity: 65±20%
- c. Air Pressure: 86kPa to 106kPa

5.1.2 If any doubt on the results, measurements/tests should be made within the following limits:

- a. Ambient Temperature: 20±2°C
- b. Relative Humidity: 65±5%
- c. Air Pressure: 86kPa to 106kPa

5.2 Visual Examination

- a. Inspection Equipment: 20× magnifier

5.3 Electrical Test

5.3.1 DC Resistance (DCR)

- a. Refer to Item 3.
- b. Test equipment (Analyzer): High Accuracy Milliohmmeter-HP4338B or equivalent.

5.3.2 Impedance (Z)

- a. Refer to Item 3.
- b. Test equipment: High Accuracy RF Impedance /Material Analyzer-E4991A or equivalent.
Test fixture: HP16197A for 0603, HP16192A for 1005/1608/2012/3216.
Test signal: -20dBm or 50mV
- c. Test frequency refers to Item 3.

5.3.3 Rated Current

- a. Refer to **Item 3**.
- b. Test equipment (see **Fig.5.3.3-1**): Electric Power, Electric current meter, Thermometer.
- c. Measurement method (see **Fig. 5.3.3-1**):
 1. Set test current to be 0 mA.
 2. Measure initial temperature of chip surface.
 3. Gradually increase voltage and measure chip temperature for corresponding current.
- d. Definition of Rated Current (I_r): I_r is direct electric current as chip surface temperature rose just 20°C against chip initial surface temperature (T_a) (see **Fig. 5.3.3-2**)

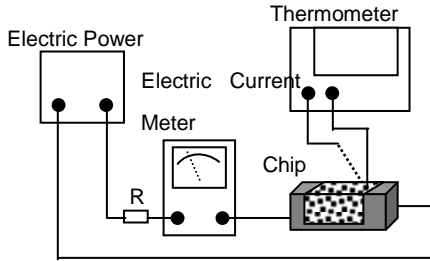

Fig. 5.3.3-1

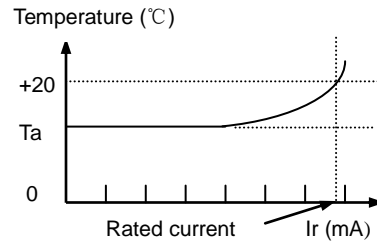
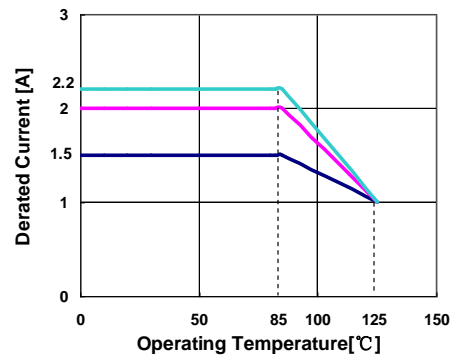
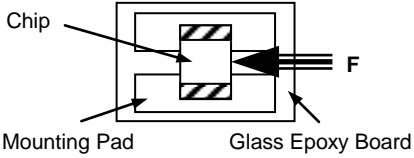
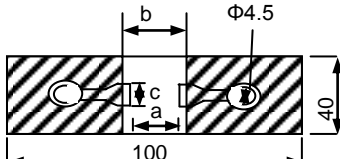
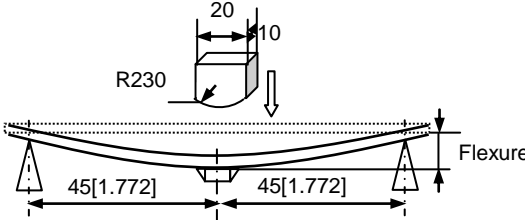
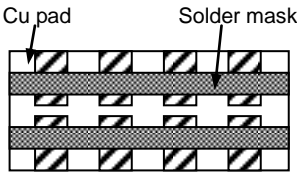

Fig. 5.3.3-2

- e. When operating temperatures exceeding $+85^{\circ}\text{C}$, derating of current is necessary for chip ferrite beads for which rated current is 1000mA over. Please apply the derating curve shown in chart according to the operating temperature.



5.4 Reliability Test

Items	Requirements	Test Methods and Remarks								
5.4.1 Terminal Strength	No removal or split of the termination or other defects shall occur.  Fig.5.4.1-1	① Solder the bead to the testing jig (glass epoxy board shown in Fig. 5.4.1-1) using leadfree solder. Then apply a force in the direction of the arrow. ② 10N force for 3216 series. ③ Keep time: 10±1s. ④ Speed: 1.0mm/s.								
5.4.2 Resistance to Flexure	No visible mechanical damage. <table border="1" data-bbox="325 539 756 622"> <thead> <tr> <th>Type</th> <th>a</th> <th>b</th> <th>c</th> </tr> </thead> <tbody> <tr> <td>3216[1206]</td> <td>2.2</td> <td>5.0</td> <td>2.0</td> </tr> </tbody> </table> Unit: mm [inch]  Fig. 5.4.2-1	Type	a	b	c	3216[1206]	2.2	5.0	2.0	① Solder the bead to the test jig (glass epoxy board shown in Fig. 5.4.2-1) Using a leadfree solder. Then apply a force in the direction shown Fig. 5.4.2-2 . ② Flexure: 2mm. ③ Pressurizing Speed: 0.5mm/sec. ④ Keep time: 30 sec.  Fig. 5.4.2-2
Type	a	b	c							
3216[1206]	2.2	5.0	2.0							
5.4.3 Vibration	① No visible mechanical damage. ② Impedance change: within ±20%  Glass Epoxy Board Fig. 5.4.3-1	① Solder the bead to the testing jig (glass epoxy board shown in Fig. 5.4.3-1) using leadfree solder. ② The bead shall be subjected to a simple harmonic motion having total amplitude of 1.5 mm, the frequency being varied uniformly between the approximate limits of 10 and 55 Hz. ③ The frequency range from 10 to 55 Hz and return to 10 Hz shall be traversed in approximately 1 minute. This motion shall be applied for a period of 2 hours in each 3 mutually perpendicular directions (total of 6 hours).								
5.4.4 Dropping	① No visible mechanical damage. ② Impedance change: within ±20%.	Drop chip bead 10 times on a concrete floor from a height of 100 cm.								
5.4.5 Temperature	Impedance change should be within ±20% of initial value measuring at 20°C.	Temperature range: -55°C ~ 125°C. Reference temperature: +20°C.								
5.4.6 Solderability	① No visible mechanical damage. ② Wetting shall exceed 75% coverage for 0603 series; exceed 95% for others	① Solder temperature: 240±2°C ② Duration: 3 sec. ③ Solder: Sn/3.0Ag/0.5Cu. ④ Flux: 25% Resin and 75% ethanol in weight.								
5.4.7 Resistance to Soldering Heat	① No visible mechanical damage. ② Wetting shall exceed 75% coverage for 0603 series; exceed 95% for others ③ Impedance change: within ±20%.	① Solder temperature :260±3°C ② Duration: 5 sec. ③ Solder: Sn/3.0Ag/0.5Cu. ④ Flux: 25% Resin and 75% ethanol in weight. ⑤ The chip shall be stabilized at normal condition for 1~2 hours before measuring.								

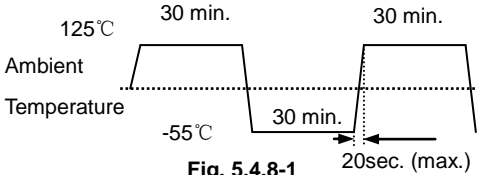
<p>5.4.8 Thermal Shock</p>	<p>① No mechanical damage. ② Impedance change: Within $\pm 20\%$.</p>  <p style="text-align: center;">Fig. 5.4.8-1</p>	<p>① Temperature, Time: (See Fig.5.4.8-1) -55°C for 30±3 min→125°C for 30±3min. ② Transforming interval: Max. 20 sec. ③ Tested cycle: 100 cycles. ④ The chip shall be stabilized at normal condition for 1~2 hours before measuring.</p>
<p>5.4.9 Resistance to Low Temperature</p>	<p>① No mechanical damage. ② Impedance change: within $\pm 20\%$.</p>	<p>① Temperature: -55±2°C ② Duration: 1000⁺²⁴ hours. ③ The chip shall be stabilized at normal condition for 1~2 hours before measuring.</p>
<p>5.4.10 Resistance to High Temperature</p>	<p>① No mechanical damage. ② Impedance change: within $\pm 20\%$.</p>	<p>① Temperature: 125±2°C ② Duration: 1000⁺²⁴ hours. ③ The chip shall be stabilized at normal condition for 1~2 hours before measuring.</p>
<p>5.4.11 Damp Heat (Steady States)</p>	<p>① No mechanical damage. ② Impedance change: Within $\pm 20\%$.</p>	<p>① Temperature: 60±2°C ② Humidity: 90% to 95% RH. ③ Duration: 1000⁺²⁴ hours. ④ The chip shall be stabilized at normal condition for 1~2 hours before measuring.</p>
<p>5.4.12 Loading Under Damp Heat</p>	<p>① No visible mechanical damage. ② Impedance change: within $\pm 20\%$.</p>	<p>① Temperature: 60±2°C ② Humidity: 90% to 95% RH. ③ Duration: 1000⁺²⁴ hours. ④ Applied current: Rated current. ⑤ The chip shall be stabilized at normal condition for 1~2 hours before measuring.</p>
<p>5.4.13 Loading at High Temperature (Life Test)</p>	<p>① No visible mechanical damage. ② Impedance change: within $\pm 20\%$.</p>	<p>① Temperature: 125±2°C ② Duration: 1000⁺²⁴ hours. ③ Applied current: Rated current. ④ The chip shall be stabilized at normal condition for 1~2 hours before measuring.</p>

6. Packaging, Storage

6.1 Packaging

Tape Carrier Packaging:

Packaging code: T

- a. Tape carrier packaging are specified in attached figure **Fig.6.1-1~3**
- b. Tape carrier packaging quantity please see the following table:

Type	3216[1206]
T(mm)	0.85±0.2
Tape	Paper Tape
Quantity	3K

(1) Taping Drawings (Unit: mm)

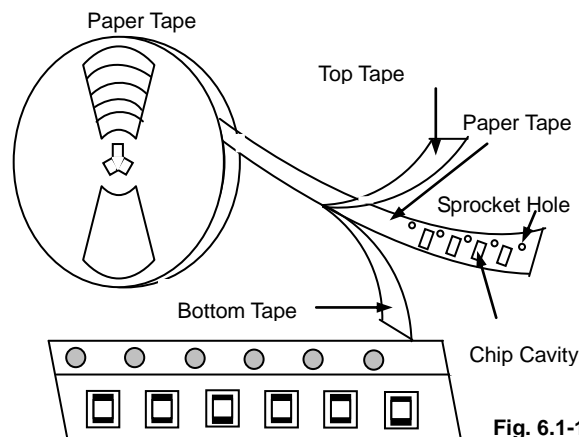
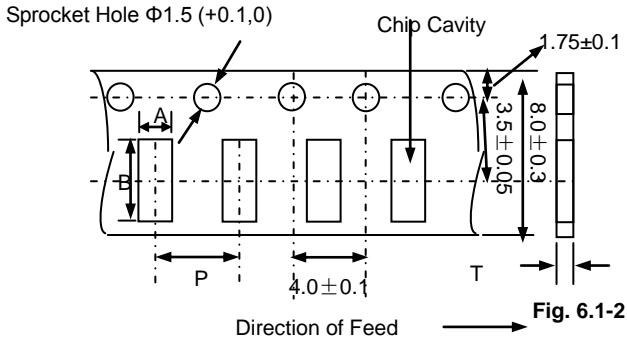

Fig. 6.1-1

Remark: The sprocket holes are to the right as the tape is pulled toward the user.

(2) Taping Dimensions (Unit: mm)



Paper Tape

Type	A	B	P	T max
3216[1206]	1.9±0.2	3.5±0.2	4.0±0.1	1.1

(3) Reel Dimensions (Unit: mm)

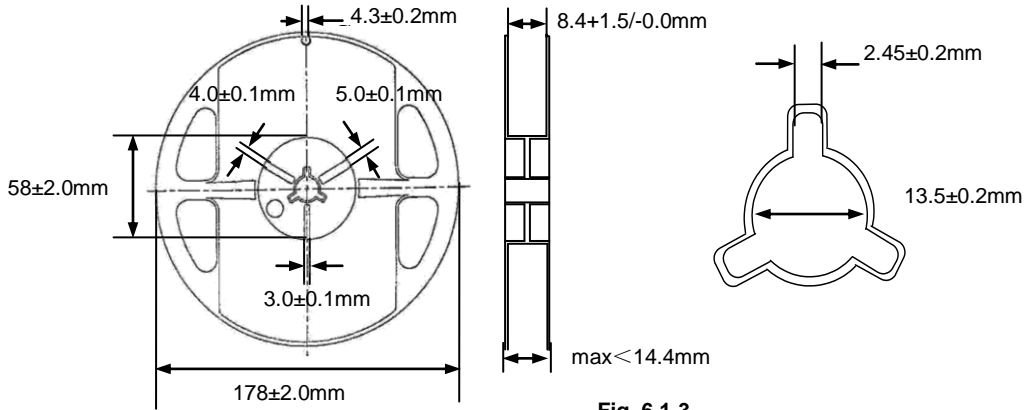

6.2 Storage

- a. The solderability of the external electrode may be deteriorated if packages are stored where they are exposed to high humidity. Package must be stored at 40°C or less and 70% RH or less.
- b. The solderability of the external electrode may be deteriorated if packages are stored where they are exposed to dust or harmful gas (e.g. HCl, sulfurous gas of H₂S).
- c. Packaging material may be deformed if package are stored where they are exposed to heat of direct sunlight.
- d. Solderability of the products with external dimensions as 0603[0201] specified in Clause 5.4.6 shall be guaranteed for 6 months from the date of delivery on condition that they are stored at the environment specified in Clause 3. For those parts, which passed more than 6 months shall be checked solder-ability before use.
- e. Solderability of the products, except ones with external dimensions as 0603[0201], specified in Clause 5.4.6 shall be guaranteed for 12 months from the date of delivery on condition that they are stored at the environment specified in Clause 3. For those parts, which passed more than 12 months shall be checked solder-ability before use.

7. Recommended Soldering Technologies

7.1 Re-flowing Profile:

- △ Preheat condition: 150 ~200°C/60~120sec.
- △ Allowed time above 217°C: 60~90sec.
- △ Max temp: 260°C
- △ Max time at max temp: 10sec.
- △ Solder paste: Sn/3.0Ag/0.5Cu
- △ Allowed Reflow time: 2x max

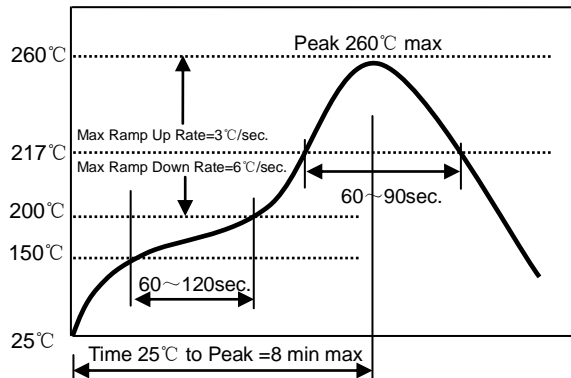

[Note: The reflow profile in the above table is only for qualification and is not meant to specify board assembly profiles. Actual board assembly profiles must be based on the customer's specific board design, solder paste and process, and should not exceed the parameters as the Reflow profile shows.]

7.2 Iron Soldering Profile.

- △ Iron soldering power: Max.30W
 - △ Pre-heating: 150 °C / 60sec.
 - △ Soldering Tip temperature: 350°CMax.
 - △ Soldering time: 3sec Max.
 - △ Solder paste: Sn/3.0Ag/0.5Cu
 - △ Max.1 times for iron soldering
- [Note: Take care not to apply the tip of the soldering iron to the terminal electrodes.]

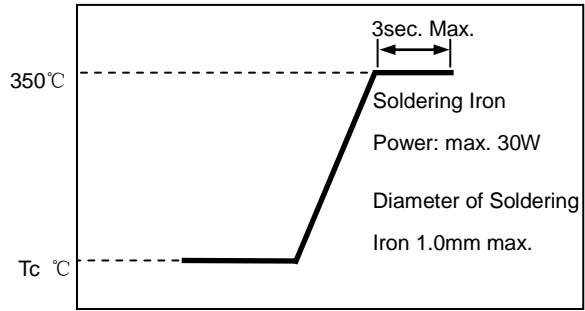
**8. Supplier Information**

- a) Supplier:
Shenzhen Sunlord Electronics Co., Ltd.
- b) Manufacture:
Shenzhen Sunlord Electronics Co., Ltd.
- c) Manufacturing Address:
Sunlord Industrial Park, Dafuyuan Industrial Zone, Guanlan, Shenzhen, China 518110

X-ON Electronics

Largest Supplier of Electrical and Electronic Components

Click to view similar products for [Ferrite Beads](#) category:

Click to view products by [Sunlord](#) manufacturer:

Other Similar products are found below :

[2943778301](#) [BMB1J0120BN3JIT](#) [82350120560](#) [0261014605](#) [2643066902](#) [3061000011](#) [2673045901](#) [2643083601](#) [2643074901](#) [4361142521](#)
[4078078621](#) [4078044821](#) [4078033621](#) [CZB2BFTTE121P](#) [BMB2A0120AN2](#) [BMB1J0200BN3JIT](#) [EMI0805R-220](#) [74279250](#) [7427924](#)
[CZB1JGTTD202P](#) [MAF0603GWY551AT000](#) [MAF1005GWZ102AT000](#) [BLM18HE152SH1D](#) [2944778302](#) [BLM02PX600SN1D](#) [SMB2.5-1](#)
[EMI1206R-600](#) [BLM02KX180SN1D](#) [BLM02BC100SN1D](#) [BLM02KX100SN1D](#) [BLM02BB101SN1D](#) [BLM02BC220SN1D](#)
[BLE32PN260SH1L](#) [BLE32PN260SN1L](#) [BLE32PN260SZ1L](#) [74275013](#) [7427503](#) [BLM18HE601SH1D](#) [BLM15BD152SN1D](#)
[BLM15BD152SZ1D](#) [BLE18PS080SZ1D](#) [BLM21PG221BH1D](#) [WLBD1005HCU330TL](#) [BLM21AG471BH1D](#) [BLE18PS080BH1D](#)
[BLM21AG331BH1D](#) [BLM21PG300BH1D](#) [BLM21PG600BH1D](#) [BLM03HB401SZ1D](#) [BLM03HB401SN1D](#)