

# SPECIFICATIONS

<b>Customer</b>	
<b>Product Name</b>	<b>Multi-layer Chip Power Inductor</b>
<b>Sunlord Part Number</b>	<b>MPL1608S4R7MHT</b>
<b>Customer Part Number</b>	

New Released,  Revised]

**SPEC No.:** **MPL081900030**

Rev.	Effective Date	Changed Contents	Change Reasons	Approved By
01	Jun.11,2019	New release	/	Hai Guo

**【 This SPEC is total 9 pages including specifications and appendix. 】**

**【 ROHS Compliant Parts 】**

Approved By	Checked By	Issued By

## Shenzhen Sunlord Electronics Co., Ltd.

Address: Sunlord Industrial Park, Dafu Industrial Zone, Baoan, Shenzhen, China 518110

Tel: 0086-755-29832660

Fax: 0086-755-82269029

E-Mail: sunlord@sunlordinc.com

### **【 For Customer approval Only 】**

Date: \_\_\_\_\_

Qualification Status:  Full  Restricted  Rejected

Approved By	Verified By	Re-checked By	Checked By

Comments:

\_\_\_\_\_

**Caution**

All products listed in this specification are developed, designed and intended for use in general electronics equipment. The products are not designed or warranted to meet the requirements of the applications listed below, whose performance and/or quality require especially high reliability, or whose failure, malfunction or trouble might directly cause damage to society, person, or property. Please understand that we are not responsible for any damage or liability caused by use of the products in any of the applications below. Please contact us for more details if you intend to use our products in the following applications.

1. Aircraft equipment
2. Aerospace equipment
3. Undersea equipment
4. nuclear control equipment
5. military equipment
6. Power plant equipment
7. Medical equipment
8. Transportation equipment (automobiles, trains, ships, etc.)
9. Traffic signal equipment
10. Disaster prevention / crime prevention equipment
11. Data-processing equipment
12. Applications of similar complexity or with reliability requirements comparable to the applications listed in the above

1. Scope

This specification applies to MPL1608S4R7MHT of multi-layer chip power inductors

2. Product Description and Identification (Part Number)

- 1) Description  
MPL1608S4R7MHT of multi-layer chip power inductors.
- 2) Product Identification (Part Number)

MPL    1608    S    4R7    M    H    I  
 ①        ②        ③        ④        ⑤        ⑥        ⑦

①Type	
MPL	Chip Power Inductor

②External Dimensions (L x W) (mm)	
1608 [0603]	1.6 x 0.8

③Feature Type	
S	Standard

④Nominal Inductance	
Example	Nominal Value
4R7	4.7μH

⑤Inductance Tolerance	
M	±20%

⑥Thickness	
H	0.9 mm

⑦Packing	
T	Tape Carrier Package

3. Electrical Characteristics

Part Number	L (μH)	L Test Freq. (MHz)	S.R.F Min. (MHz)	DCR (Ω)	Temperature Rise Current I <sub>DC1</sub> (mA.) (max.)	Saturation Current I <sub>DC2</sub> (mA) (Typ.)
MPL1608S4R7MHT	4.7	1	40	0.45±25%	620	100

- 1) Operating and storage temperature range (individual chip without packing): -40°C ~ +85°C
- 2) Storage temperature range (packaging conditions): -10°C~+40°C and RH 70% (Max.)

4. Shape and Dimensions

- 1) Dimensions and recommended PCB pattern for reflow soldering: See Fig.4-1, Fig.4-2 and Table 4-1.
- 2) Structure: See Fig. 4-3 and Fig. 4-4.

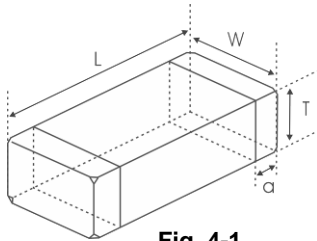

Fig. 4-1

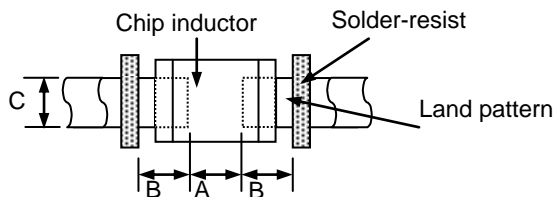

Fig. 4-2

[Table 4-1]

Unit: mm [inch]

Type	L	W	T	a	A	B	C
1608 [0603]	1.60±0.15 [063±006]	0.8±0.15 [031±006]	0.8±0.15 [031±006]	0.3±0.2 [012±008]	0.6~0.8	0.6~0.8	0.6~0.8

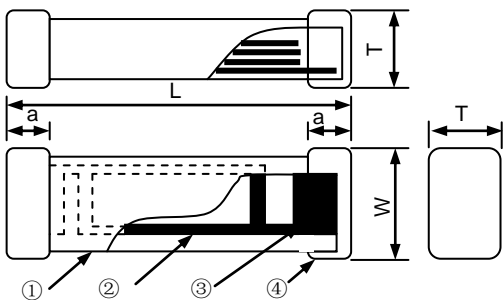

Fig. 4-3

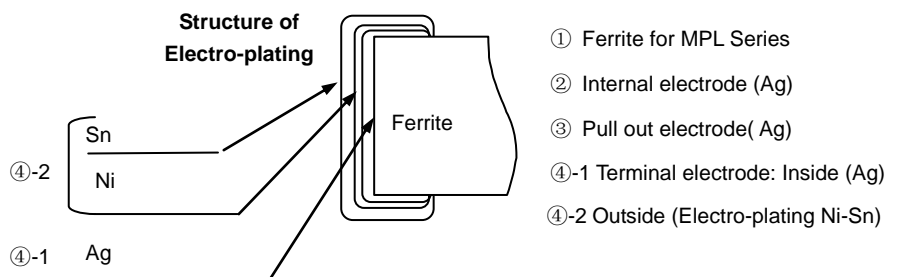

Fig. 4-4

- ① Ferrite for MPL Series
- ② Internal electrode (Ag)
- ③ Pull out electrode (Ag)
- ④-1 Terminal electrode: Inside (Ag)
- ④-2 Outside (Electro-plating Ni-Sn)

- 3) Material Information: See **Table 4-2**.

[Table 4-2]

Code	Part Name	Material Name
①	Ferrite Body	Ferrite Powder
②	Inner Coils	Silver Paste
③	Pull-out Electrode (Ag)	Silver Paste
④-1	Terminal Electrode: Inside Ag	Termination Silver Composition
④-2	Electro-Plating: Ni/Sn plating	Plating Chemicals

## 5. Test and Measurement Procedures

### 5.1 Test Conditions

Unless otherwise specified, the standard atmospheric conditions for measurement/test as:

- Ambient Temperature:  $20 \pm 15^\circ\text{C}$
- Relative Humidity:  $65 \pm 20\%$
- Air Pressure: 86 kPa to 106 kPa

If any doubt on the results, measurements/tests should be made within the following limits:

- Ambient Temperature:  $20 \pm 2^\circ\text{C}$
- Relative Humidity:  $65 \pm 5\%$
- Air Pressure: 86kPa to 106 kPa

### 5.2 Visual Examination

- Inspection Equipment: 20x magnifier

### 5.3 Electrical Test

#### 5.3.1 DC Resistance (DCR)

- Refer to **Item 3**.
- Test equipment (Analyzer): High Accuracy Milliohmmeter-HP4338B or equivalent.

#### 5.3.2 Inductance (L)

- Refer to **Item 3**.
- Test equipment: High Accuracy RF Impedance /Material Analyzer-HP4291B+HP16192A or equivalent.
- Test signal: -20dBm or 50mV.
- Test frequency refers to **Item 3**.

#### 5.3.3 Temperature Rise Current ( $I_{DC1}$ )

- Refer to **Item 3**.
- Test equipment (see **Fig. 5.3.3-1**): Electric Power, Electric current meter, Thermometer.
- Measurement method (see **Fig. 5.3.3-1**):
  - Set test current to be 0 mA.
  - Measure initial temperature of chip surface.
  - Gradually increase voltage and measure chip temperature for corresponding current.
  - Definition of Temperature Rise Current ( $I_{DC1}$ ) :  $I_{DC1}$  is direct electric current as chip surface temperature rose just  $40^\circ\text{C}$  against chip initial surface temperature ( $T_a$ ) (see **Fig. 5.3.3-2**)

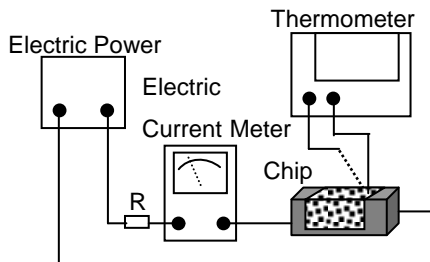

Fig. 5.3.3-1

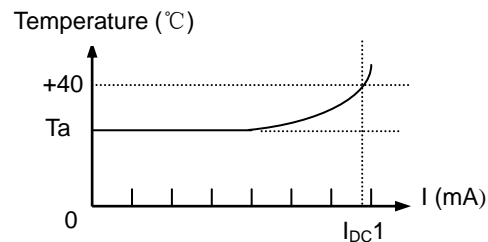

Fig. 5.3.3-2

5.3.4 Saturation Current ( $I_{DC2}$ )

- a. Refer to **Item 3**.
- b. Test equipment: HP6632B system DC power supply, HP4291B+HP16192A+HP16200A or equivalent.
- c. Measurement method:
  1. Measurement conditions of initial inductance L: Measuring Frequency: 1MHz.  
Test Current: 1mA.
  2. Raising the voltage of the DC power supply, measure the inductance at the various current.  
The rated current is the value of DC current at which the inductance will be 30% down compared with the initial inductance value.  
Note: In the period of raising voltage, voltage cannot be reduced.
  3. Definition of Saturation Current ( $I_{DC2}$ ):  $I_{DC2}$  is the value of DC current as inductance L ( $\mu\text{H}$ ) decreased just 30% against initial value (see **Fig. 5.3.4-1**).

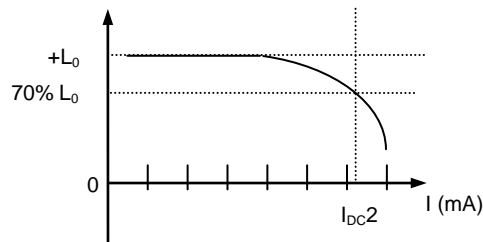
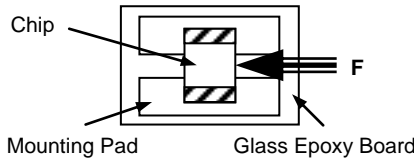
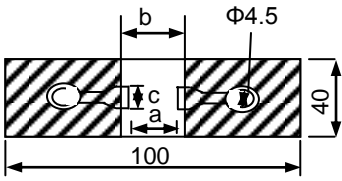
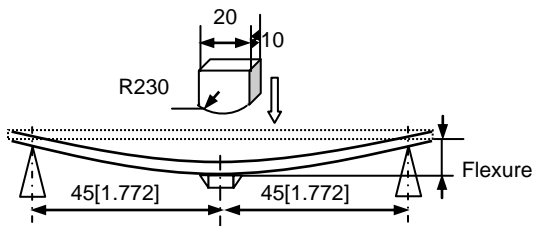
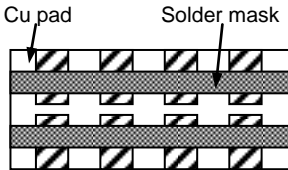

Fig. 5.3.4-1

## 5.3.5 Self-Resonant Frequency (SRF)

- a. Refer to **Item 3**.
- b. Test equipment: High Accuracy RF Impedance /Material Analyzer-HP4291B+HP16192A or equivalent.
- c. Test signal: -20dBm or 50 mV.

5.4 Reliability Test

Items	Requirements	Test Methods and Remarks								
5.4.1 Terminal Strength	No removal or split of the termination or other defects shall occur.   <p style="text-align: center;"><b>Fig.5.4.1-1</b></p>	<ol style="list-style-type: none"> <li>① Solder the inductor to the testing jig (glass epoxy board shown in <b>Fig.5.4.1-1</b>) using eutectic solder. Then apply a 10N force in the direction of the arrow.</li> <li>② Keep time: 10±1s.</li> <li>③ Speed: 1.0mm/s.</li> </ol>								
5.4.2 Resistance to Flexure	No visible mechanical damage.  Unit: mm [inch] <table border="1" data-bbox="343 571 766 660" style="margin-left: auto; margin-right: auto;"> <thead> <tr> <th>Type</th> <th>a</th> <th>b</th> <th>c</th> </tr> </thead> <tbody> <tr> <td>1608[0603]</td> <td>1.0</td> <td>3.0</td> <td>1.2</td> </tr> </tbody> </table>  <p style="text-align: center;"><b>Fig.5.4.2-1</b></p>	Type	a	b	c	1608[0603]	1.0	3.0	1.2	<ol style="list-style-type: none"> <li>① Solder the inductor to the test jig (glass epoxy board shown in <b>Fig.5.4.2-1</b>) Using a eutectic solder. Then apply a force in the direction shown <b>Fig. 5.4.2-2</b>.</li> <li>② Flexure: 2mm.</li> <li>③ Pressurizing Speed: 0.5mm/sec.</li> <li>④ Keep time: 30 sec.</li> </ol>  <p style="text-align: center;"><b>Fig. 5.4.2-2</b></p>
Type	a	b	c							
1608[0603]	1.0	3.0	1.2							
5.4.3 Vibration	<ol style="list-style-type: none"> <li>① No visible mechanical damage.</li> <li>② Inductance change: Within ±20%.</li> </ol>  <p style="text-align: center;"><b>Fig. 5.4.3-1</b></p>	<ol style="list-style-type: none"> <li>① Solder the inductor to the testing jig (glass epoxy board shown in <b>Fig.5.4.3-1</b>) using eutectic solder.</li> <li>② The inductor shall be subjected to a simple harmonic motion having total amplitude of 1.5mm, the frequency being varied uniformly between the approximate limits of 10 and 55 Hz.</li> <li>③ The frequency range from 10 to 55 Hz and return to 10 Hz shall be traversed in approximately 1 minute. This motion shall be applied for a period of 2 hours in each 3 mutually perpendicular directions (total of 6 hours).</li> </ol>								
5.4.4 Dropping	<ol style="list-style-type: none"> <li>① No visible mechanical damage.</li> <li>② Inductance change: Within ±20%.</li> </ol>	Drop chip inductor 10 times on a concrete floor from a height of 100 cm.								
5.4.5 Temperature	Inductance change should be within ±20% of initial value measuring at 20℃.	Temperature range: -40℃~ +85℃ Reference temperature: +20℃								
5.4.6 Solderability	<ol style="list-style-type: none"> <li>① No visible mechanical damage.</li> <li>② Wetting shall exceed 95% coverage.</li> </ol>	<ol style="list-style-type: none"> <li>① Solder temperature: 240±2℃</li> <li>② Duration: 3 sec.</li> <li>③ Solder: Sn/3.0Ag/0.5Cu.</li> <li>④ Flux: 25% Resin and 75% ethanol in weight.</li> </ol>								
5.4.7 Resistance to Soldering Heat	<ol style="list-style-type: none"> <li>① No visible mechanical damage.</li> <li>② Wetting shall exceed 95% coverage.</li> <li>③ Inductance change: Within ±20%.</li> </ol>	<ol style="list-style-type: none"> <li>① Solder temperature: 260±3℃.</li> <li>② Duration: 5 sec.</li> <li>③ Solder: Sn/3.0Ag/0.5Cu.</li> <li>④ Flux: 25% Resin and 75% ethanol in weight.</li> <li>⑤ The chip shall be stabilized at normal condition for 1~2 hours before measuring.</li> </ol>								

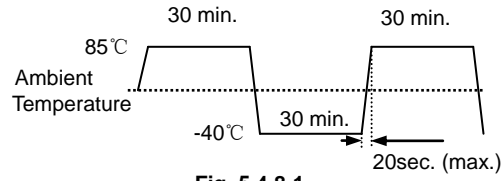
Items	Requirements	Test Methods and Remarks
5.4.8 Thermal Shock	① No mechanical damage. ② Inductance change: Within $\pm 20\%$ .  <p style="text-align: center;"><b>Fig. 5.4.8-1</b></p>	① Temperature, Time: (See Fig.5.4.8-1) -40°C for 30±3 min→ 85°C for 30±3min. ② Transforming interval: 20 sec.(max.). ③ Tested cycle: 100 cycles. ④ The chip shall be stabilized at normal condition for 1~2 hours before measuring.
5.4.9 Resistance to Low Temperature	① No mechanical damage. ② Inductance change: Within $\pm 20\%$ .	① Temperature: $-40\pm 2^\circ\text{C}$ ② Duration: 1000 <sup>+24</sup> hours. ③ The chip shall be stabilized at normal condition for 1~2 hours before measuring.
5.4.10 Resistance to High Temperature	① No mechanical damage. ② Inductance change: Within $\pm 20\%$ .	① Temperature: $85\pm 2^\circ\text{C}$ ② Duration: 1000 <sup>+24</sup> hours. ③ The chip shall be stabilized at normal condition for 1~2 hours before measuring.
5.4.11 Damp Heat (Steady States)	① No visible mechanical damage. ② Inductance change: Within $\pm 20\%$ .	① Temperature: $60\pm 2^\circ\text{C}$ ② Humidity: 90% to 95% RH. ③ Duration: 1000 <sup>+24</sup> hours. ④ The chip shall be stabilized at normal condition for 1~2 hours before measuring.

**6. Packaging and Storage**

**6.1 Packaging**

Tape Carrier Packaging:

Packaging code: T

- a. Tape carrier packaging are specified in attached figure Fig.6.1-1~3
- b. Tape carrier packaging quantity please see the following table:

Type	1608[0603]
T(mm)	0.8±0.15
Tape	PaperTape
Quantity	4K

- c. Reel shall be packaged in vinyl bag.
- d. Maximum of 5 or 10 reels bags shall be packaged in an inner box.
- e. Maximum of 6 or 10 inner boxes shall be packaged in an outer case.

(1) Taping Drawings (Unit: mm)

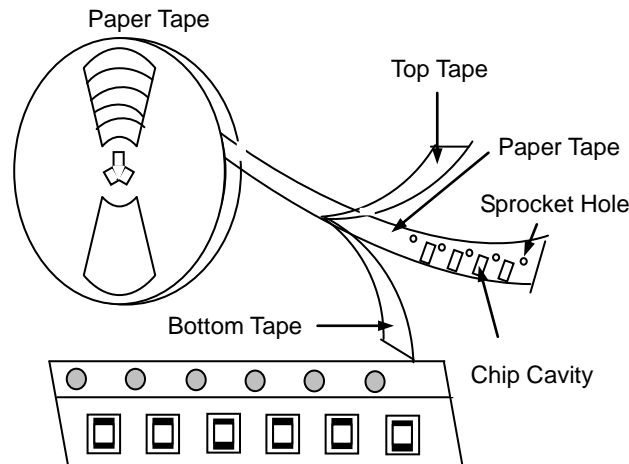

**Fig 6.1-1**

**Remark:** The sprocket holes are to the right as the tape is pulled toward the user.

(2) Taping Dimensions (Unit: mm)

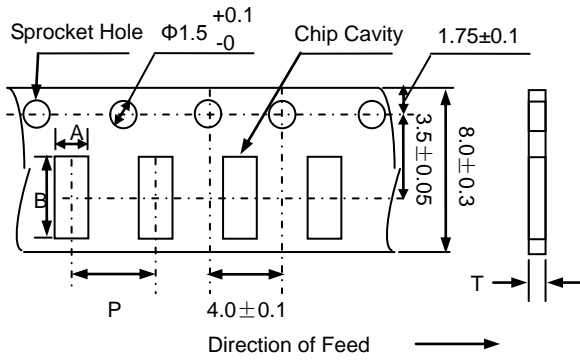

Type	A	B	P	Tmax
MPL1608_H	1.0±0.2	1.8±0.2	4.0±0.1	1.1

Fig 6.1-2

(3) Reel Dimensions (Unit: mm)

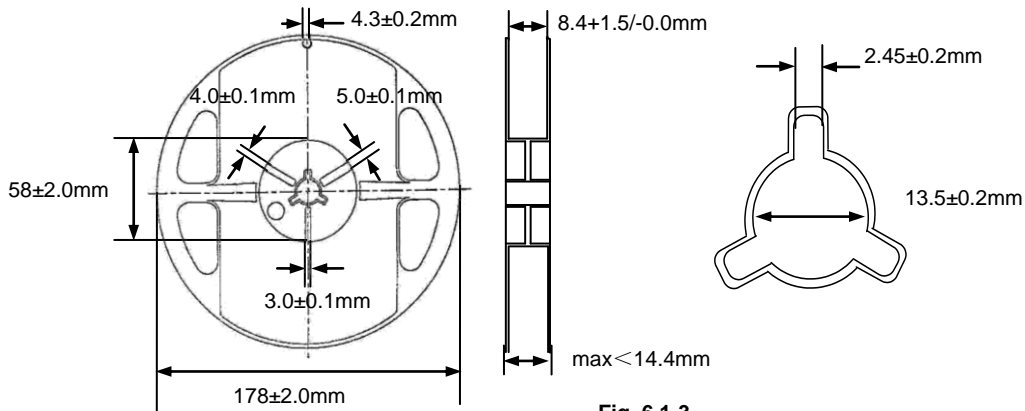

Fig. 6.1-3

6.2 Storage

- a. The solderability of the external electrode may be deteriorated if packages are stored where they are exposed to high humidity. Package must be stored at 40°C or less and 70% RH or less.
- b. The solderability of the external electrode may be deteriorated if packages are stored where they are exposed to dust of harmful gas (e.g. HCl, sulfurous gas of H<sub>2</sub>S).
- c. Packaging material may be deformed if package are stored where they are exposed to heat of direct sunlight.
- d. Solderability specified in **Clause 5.4.6** shall be guaranteed for 12 months from the date of delivery on condition that they are stored at the environment specified in **Clause 3** .For those parts, which passed more than 12 months shall be checked solder-ability before use.



7. Recommended Soldering Technologies

7.1 Reflowing Profile:

- △ Preheat condition: 150 ~200°C/60~120sec.
- △ Allowed time above 217°C: 60~90sec.
- △ Max temp: 260°C
- △ Max time at max temp: 10sec.
- △ Solder paste: Sn/3.0Ag/0.5Cu
- △ Allowed Reflow time: 2x max

[Note: The reflow profile in the above table is only for qualification and is not meant to specify board assembly profiles. Actual board assembly profiles must be based on the customer's specific board design, solder paste and process, and should not exceed the parameters as the Reflow profile shows.]

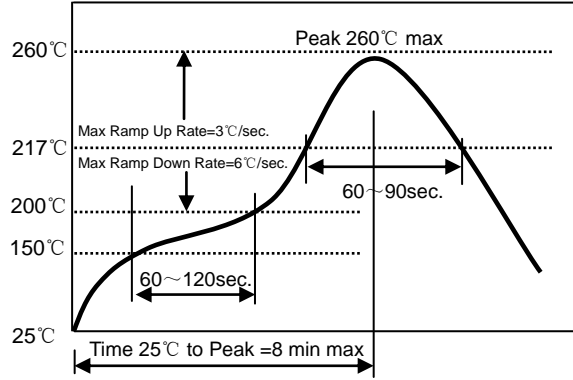

7.2 Iron Soldering Profile.

- △ Iron soldering power: Max.30W
- △ Pre-heating: 150 °C / 60sec.
- △ Soldering Tip temperature: 350°C Max.
- △ Soldering time: 3sec Max.
- △ Solder paste: Sn/3.0Ag/0.5Cu
- △ Max.1 times for iron soldering

[Note: Take care not to apply the tip of the soldering iron to the terminal electrodes.]

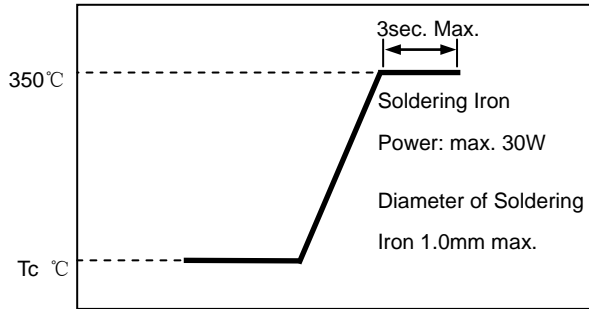

8. Supplier Information

- a) Supplier:  
**Shenzhen Sunlord Electronics Co., Ltd.**
- b) Manufacturer:  
**Shenzhen Sunlord Electronics Co., Ltd.**
- c) Manufacturing Address:  
**Sunlord Industrial Park, Dafuyuan Industrial Zone, Guanlan, Shenzhen, China 518110**

## X-ON Electronics

Largest Supplier of Electrical and Electronic Components

*Click to view similar products for [Fixed Inductors](#) category:*

*Click to view products by [Sunlord](#) manufacturer:*

Other Similar products are found below :

[CR32NP-151KC](#) [CR32NP-180KC](#) [CR32NP-181KC](#) [CR32NP-1R5MC](#) [CR32NP-390KC](#) [CR32NP-3R9MC](#) [CR32NP-680KC](#) [CR32NP-820KC](#) [CR32NP-8R2MC](#) [CR43NP-390KC](#) [CR43NP-560KC](#) [CR43NP-680KC](#) [CR54NP-181KC](#) [CR54NP-470LC](#) [CR54NP-820KC](#) [CR54NP-8R5MC](#) [70F224AI](#) [MGDQ4-00004-P](#) [MHL1ECTTP18NJ](#) [MHQ1005P10NJ](#) [MHQ1005P1N0S](#) [MHQ1005P2N4S](#) [MHQ1005P3N6S](#) [MHQ1005P5N1S](#) [MHQ1005P8N2J](#) [PE-51506NL](#) [PE-53601NL](#) [PE-53602NL](#) [PE-53630NL](#) [PE-53824SNLT](#) [PE-92100NL](#) [PG0434.801NLT](#) [PG0936.113NLT](#) [9220-20](#) [9310-16](#) [PM06-2N7](#) [PM06-39NJ](#) [A01TK](#) [1206CS-471XJ](#) [HC2LP-R47-R](#) [HC2-R47-R](#) [HC3-2R2-R](#) [HCF1305-3R3-R](#) [1206CS-151XG](#) [RCH664NP-140L](#) [RCH664NP-4R7M](#) [RCH8011NP-221L](#) [RCP1317NP-332L](#) [RCP1317NP-391L](#) [RCR1010NP-470M](#)