

Multilayer Chip Power Inductor – MPL Series

Operating Temp. : -40°C~+85°C

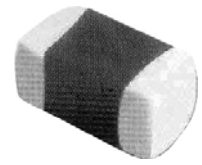

FEATURES

- High DC bias current due to developed material
- Low DC resistance
- Low profile and thin thickness
- Monolithic structure for high reliability
- Excellent solderability and high heat resistance
- No cross coupling due to magnetic shield

APPLICATIONS

- DC-DC converter circuits for mobile phones, DSCs, DVCs, HDDs, PDAs, etc.

PRODUCT IDENTIFICATION

MPL **2012** **S** **2R2** **M** **H** **I**

① ② ③ ④ ⑤ ⑥ ⑦

①

Type	
MPL	Chip Power Inductor

②

External Dimensions (L×W) (mm)	
1608 [0603]	1.6×0.8
2012 [0805]	2.0×1.25
2016 [0806]	2.0×1.6
2520 [1008]	2.5×2.0

④

Nominal Inductance	
Example	Nominal Value
R47	0.47μH
4R7	4.7μH

③

Feature Type	
S	(Internal Code)
L	
C	

⑥

Thickness	
D	0.5mm
H	0.9mm
W	1.1mm
Y	1.25mm

⑦

Packing	
T	Tape & Reel

⑤

Inductance Tolerance	
M	±20%
N	±30%

SHAPE AND DIMENSIONS

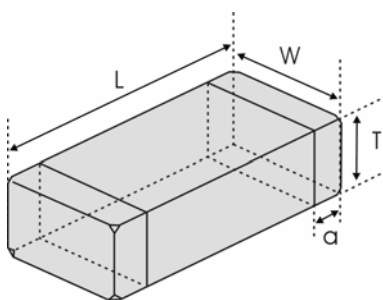

Unit: mm [inch]

Type	L	W	T	a
1608 [0603]	1.6±0.15 [.063±.006]	0.8±0.15 [.031±.006]	0.5±0.1 [.020±.004]	0.3±0.2 [.012±.008]
			0.8±0.15 [.031±.006]	
2012 [0805]	2.0 (+0.3, -0.1) [.079 (+.012, -.004)]	1.25±0.2 [.049±.008]	0.5±0.1 [.020±.004]	0.5±0.3 [.020±.012]
			0.9±0.1 [.035±.004]	
			1.25±0.2 [.049±.008]	
2016 [0806]	2.0 (+0.3, -0.1) [.079 (+.012, -.004)]	1.6±0.2 [.063±.008]	0.9±0.1 [.035±.004]	0.5±0.3 [.020±.012]
2520 [1008]	2.5±0.2 [.098±.008]	2.0 (+0.3, -0.1) [.079 (+.012, -.004)]	0.9±0.1 [.035±.004]	0.5±0.3 [.020±.012]
			1.1±0.1 [.043±.004]	

SPECIFICATIONS

MPL1608 TYPE

Part Number	Inductance	L Test Freq.	Min. Self-resonant Frequency	DC Resistance	Max. Rated Current	Thickness
Units	μH	MHz	MHz	Ω	mA	mm [inch]
Symbol	L	Freq.	S.R.F	DCR	I_r^*	T
MPL1608SR47□DT	0.47	5	105	0.19±25%	900	0.5±0.1 [.020±.004]
MPL1608LR47□HT	0.47	5	105	0.12±25%	1200	0.8±0.15 [.031±.006]
MPL1608SR47□HT	0.47	5	105	0.25±25%	800	
MPL1608SR68□HT	0.68	5	90	0.16±25%	1000	
MPL1608S1R0□HT	1.0	1	75	0.20±25%	950	
MPL1608S1R5□HT	1.5	1	50	0.25±25%	800	
MPL1608S2R2□HT	2.2	1	40	0.30±25%	750	

MPL2012 TYPE

Part Number	Inductance	L Test Freq.	Min. Self-resonant Frequency	DC Resistance	Max. Rated Current	Thickness
Units	μH	MHz	MHz	Ω	mA	mm [inch]
Symbol	L	Freq.	S.R.F	DCR	I_r^*	T
MPL2012SR47□DT	0.47	1	100	0.12±25%	1100	0.5±0.1 [.020±.004]
MPL2012S1R0□DT	1.0	1	60	0.19±25%	800	
MPL2012S1R5□DT	1.5	1	50	0.26±25%	700	
MPL2012S2R2□DT	2.2	1	40	0.34±25%	600	
MPL2012SR47□HT	0.47	1	100	0.09±25%	1200	0.9±0.1 [.035±.004]
MPL2012S1R0□HT	1.0	1	60	0.11±25%	1000	
MPL2012S1R5□HT	1.5	1	50	0.16±25%	900	
MPL2012S2R2□HT	2.2	1	40	0.25±25%	800	
MPL2012S3R3□HT	3.3	1	30	0.19±25%	900	
MPL2012S4R7□HT	4.7	1	30	0.25±25%	800	
MPL2012C2R2□HT	2.2	1	40	0.45±25%	500	
MPL2012S2R2□YT	2.2	1	40	0.33±30%	640	
MPL2012S4R7□YT	4.7	1	25	0.50±30%	600	1.25±0.2 [.049±.008]

MPL2016 TYPE

Part Number	Inductance	L Test Freq.	Min. Self-resonant Frequency	DC Resistance	Max. Rated Current	Thickness
Units	μH	MHz	MHz	Ω	mA	mm [inch]
Symbol	L	Freq.	S.R.F	DCR	I_r^*	T
MPL2016SR47□HT	0.47	1	100	0.06±25%	1600	0.9±0.1 [.035±.004]
MPL2016S1R0□HT	1.0	1	70	0.09±25%	1400	
MPL2016S1R5□HT	1.5	1	60	0.11±25%	1200	
MPL2016S2R2□HT	2.2	1	50	0.11±25%	1200	
MPL2016S3R3□HT	3.3	1	40	0.12±25%	1200	
MPL2016S4R7□HT	4.7	1	30	0.14±25%	1100	

SPECIFICATIONS

MPL2520 TYPE

Part Number	Inductance	L Test Freq.	Min. Self-resonant Frequency	DC Resistance	Max. Rated Current	Thickness
Units	μH	MHz	MHz	Ω	mA	mm [inch]
Symbol	L	Freq.	S.R.F	DCR	I_{r^*}	T
MPL2520SR47□HT	0.47	1	100	0.04±25%	1800	0.9±0.1 [.035±.004]
MPL2520S1R0□HT	1.0	1	60	0.06±25%	1600	
MPL2520S1R5□HT	1.5	1	50	0.07±25%	1500	
MPL2520S2R2□HT	2.2	1	40	0.08±25%	1300	
MPL2520S3R3□HT	3.3	1	30	0.10±25%	1200	
MPL2520S4R7□HT	4.7	1	25	0.11±25%	1100	
MPL2520S1R0□WT	1.0	1	70	0.09±25%	1500	1.1±0.1 [.043±.004]
MPL2520S2R2□WT	2.2	1	40	0.12±25%	1000	
MPL2520S3R3□WT	3.3	1	30	0.12±25%	1000	
MPL2520S4R7□WT	4.7	1	25	0.14±25%	900	
MPL2520S100□WT	10	1	15	0.30±30%	800	

※□: Please specify the inductance tolerance code (M=±20%, N=±30%).

※ I_{r^*} : DC current causes temperature rise of 40°C from 20°C ambient

TYPICAL ELECTRICAL CHARACTERISTICS

Inductance vs. Frequency Characteristics

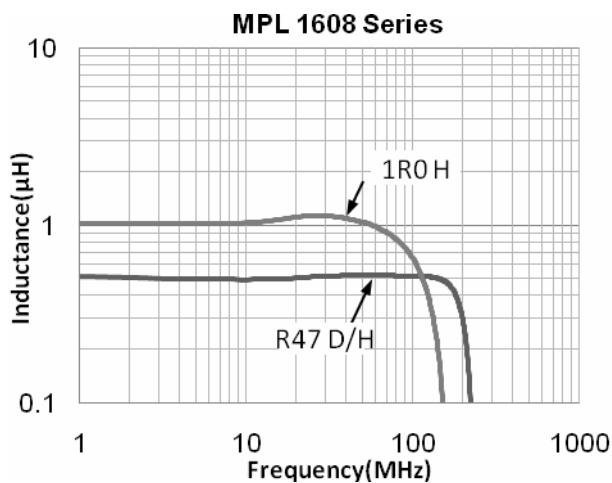

Inductance vs. DC Current Characteristics

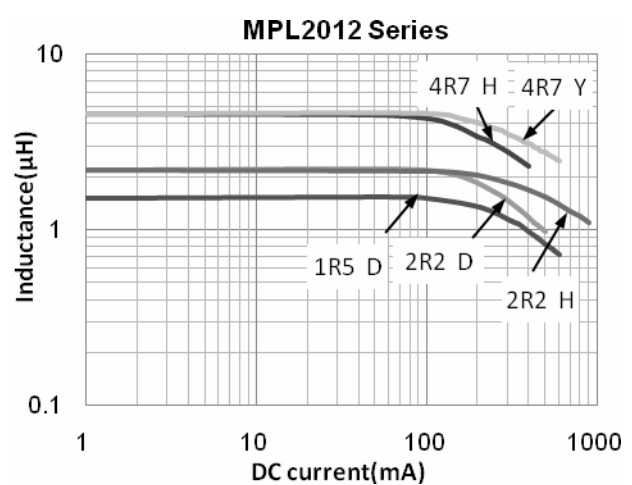
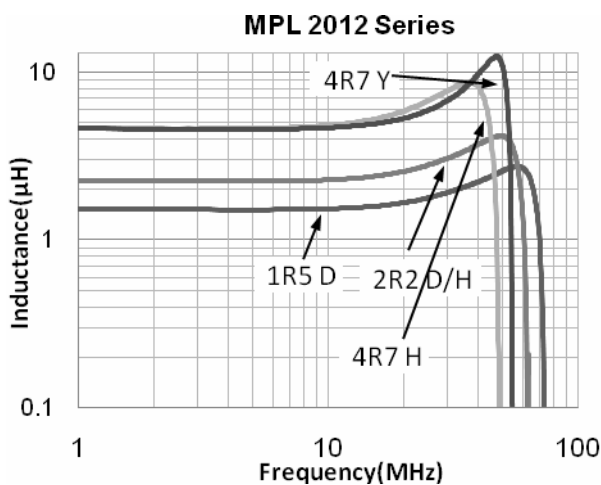
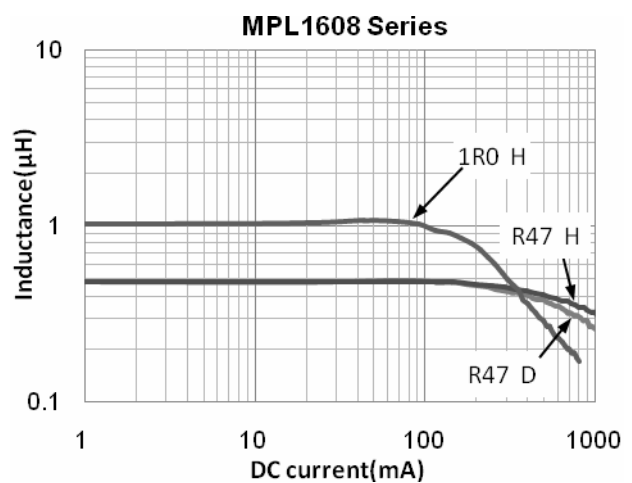

TYPICAL ELECTRICAL CHARACTERISTICS

Inductance vs. Frequency Characteristics

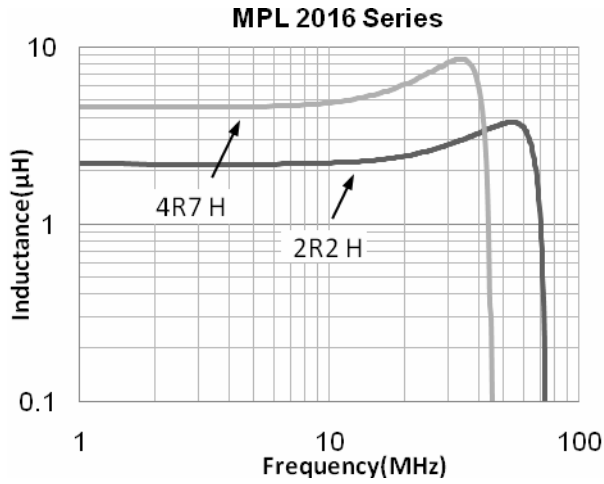

Inductance vs. DC Current Characteristics

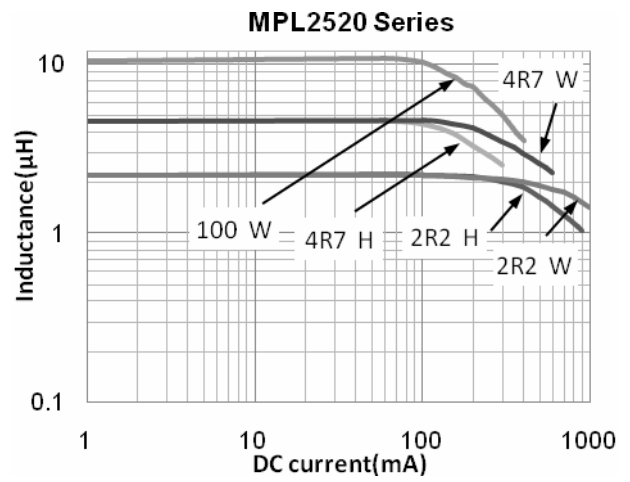
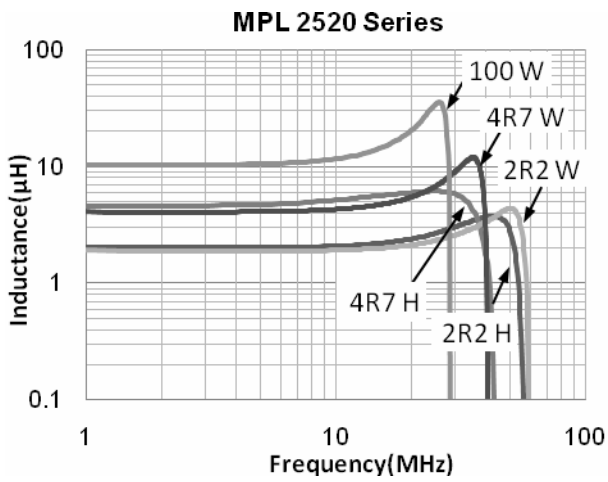
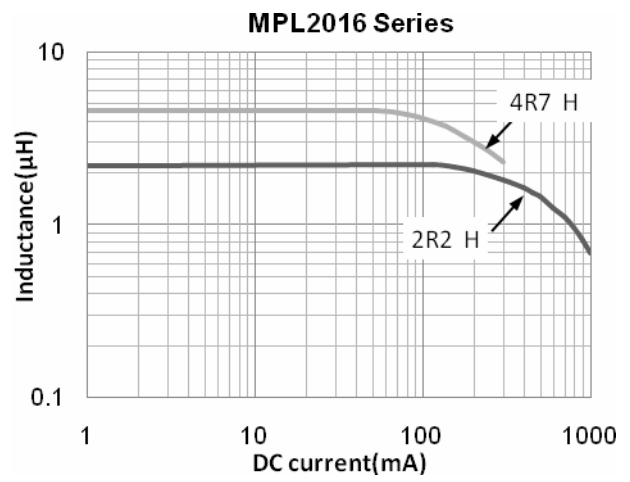

X-ON Electronics

Largest Supplier of Electrical and Electronic Components

Click to view similar products for [Fixed Inductors](#) category:

Click to view products by [Sunlord](#) manufacturer:

Other Similar products are found below :

[CR32NP-151KC](#) [CR32NP-180KC](#) [CR32NP-181KC](#) [CR32NP-1R5MC](#) [CR32NP-390KC](#) [CR32NP-3R9MC](#) [CR32NP-680KC](#) [CR32NP-820KC](#) [CR32NP-8R2MC](#) [CR43NP-390KC](#) [CR43NP-560KC](#) [CR43NP-680KC](#) [CR54NP-181KC](#) [CR54NP-470LC](#) [CR54NP-820KC](#) [CR54NP-8R5MC](#) [70F224AI](#) [MGDQ4-00004-P](#) [MHL1ECTTP18NJ](#) [MHQ1005P10NJ](#) [MHQ1005P1N0S](#) [MHQ1005P2N4S](#) [MHQ1005P3N6S](#) [MHQ1005P5N1S](#) [MHQ1005P8N2J](#) [PE-51506NL](#) [PE-53601NL](#) [PE-53602NL](#) [PE-53630NL](#) [PE-53824SNLT](#) [PE-92100NL](#) [PG0434.801NLT](#) [PG0936.113NLT](#) [9220-20](#) [9310-16](#) [PM06-2N7](#) [PM06-39NJ](#) [A01TK](#) [1206CS-471XJ](#) [HC2LP-R47-R](#) [HC2-R47-R](#) [HC3-2R2-R](#) [HCF1305-3R3-R](#) [1206CS-151XG](#) [RCH664NP-140L](#) [RCH664NP-4R7M](#) [RCH8011NP-221L](#) [RCP1317NP-332L](#) [RCP1317NP-391L](#) [RCR1010NP-470M](#)