

Multilayer Chip Ferrite Bead – PZ Series

Operating Temp. : -55°C~+125°C

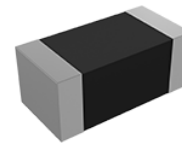

FEATURES

- Internal silver printed layers and magnetic shielded structures to minimize crosstalk
- Large withstand current (allowable current: up to 6A)
- Can be used in a wide range of frequency to suppress EMI
- Three types material and wide range of impedance values for various applications

APPLICATIONS

- Noise suppression for power line or large current signal of electric equipments such as computers and peripheral devices, DVD cameras, LCD TVs, communication equipments, OA equipments, etc

PRODUCT IDENTIFICATION

PZ

①

1608

②

U

③

121

④

-2R0

⑤

T

⑥

F

⑦

① Type	
PZ	Chip Ferrite Bead For Large Current

② External Dimensions (LxW) (mm)	
0603 [0201]	0.6x0.3
1005 [0402]	1.0x0.5
1608 [0603]	1.6x0.8
2012 [0805]	2.0x1.25
3216 [1206]	3.2x1.6
4516 [1806]	4.5x1.6

③ Material Code	
D, E, U	

⑤ Rated Current	
1R0	1.0A
2R5	2.5A
R60	0.6A

④ Nominal Impedance	
Example	Nominal Value
300	30Ω
121	120Ω
102	1000Ω

⑥ Packing	
T	Tape & Reel

⑦ Hazardous Substance Free Products	
F	

SHAPE AND DIMENSIONS

Unit: mm [inch]

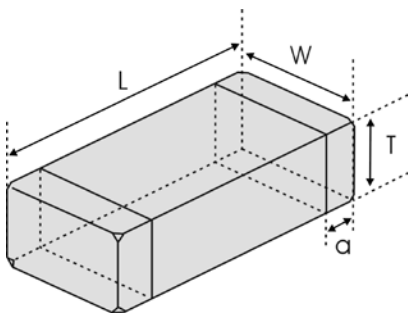

Type	L	W	T	a
PZ0603 [0201]	0.6±0.05 [.024±.002]	0.3±0.05 [.012±.002]	0.3±0.05 [.012±.002]	0.15±0.05 [.006±.002]
PZ1005 [0402]	1.0±0.15 [.039±.006]	0.5±0.15 [.020±.006]	0.5±0.15 [.020±.006]	0.25±0.1 [.010±.004]
PZ1608 [0603]	1.6±0.15 [.063±.006]	0.8±0.15 [.031±.006]	0.8±0.15 [.031±.006]	0.3±0.2 [.012±.008]
PZ2012 [0805]	2.0 (+0.3, -0.1) [.079 (+.012, -.004)]	1.25±0.2 [.049±.008]	0.85±0.2 [.033±.008]	0.5±0.3 [.020±.012]
PZ3216 [1206]	3.2±0.2 [.126±.008]	1.6±0.2 [.063±.008]	0.85±0.2 [.033±.008]	0.5±0.3 [.020±.012]
			1.1±0.2 [.043±.008]	
PZ4516 [1806]	4.5±0.2 [.178±.008]	1.6±0.2 [.063±.008]	1.6±0.2 [.063±.008]	0.5±0.3 [.020±.012]

SPECIFICATIONS

PZ0603 TYPE

Part Number	Impedance	Z Test Frequency	Max.DC Resistance	Max.Rated Current	Thickness
Units	Ω	MHz	Ω	mA	mm [inch]
Symbol	Z	Freq.	DCR	I _r	T
PZ0603D600-R50TF	60±25%	100	0.18	500	0.3±0.05 [.012±.002]
PZ0603D800-R50TF	80±25%	100	0.20	500	
PZ0603D121-R45TF	120±25%	100	0.25	450	
PZ0603D241-R35TF	240±25%	100	0.41	350	
PZ0603D601-R25TF	600±25%	100	1.00	250	
PZ0603D102-R20TF	1000±25%	100	1.40	200	
PZ0603U800-R50TF	80±25%	100	0.18	500	
PZ0603U121-R45TF	120±25%	100	0.23	450	
PZ0603U241-R35TF	240±25%	100	0.38	350	
PZ0603U601-R25TF	600±25%	100	0.85	250	
PZ0603U102-R20TF	1000±25%	100	1.25	200	

PZ1005 TYPE

Part Number	Impedance	Z Test Frequency	Max.DC Resistance	Max.Rated Current	Thickness
Units	Ω	MHz	Ω	mA	mm [inch]
Symbol	Z	Freq.	DCR	I _r	T
PZ1005D100-1R0TF	0~30	100	0.05	1000	0.5±0.15 [.020±.006]
PZ1005E100-1R8TF	0~15	100	0.02	1800	
PZ1005E700-R80TF	70±25%	100	0.10	800	
PZ1005E121-R70TF	120±25%	100	0.13	700	
PZ1005E221-R60TF	220±25%	100	0.18	600	
PZ1005E601-R45TF	600±25%	100	0.34	450	
PZ1005U700-1R2TF	70±25%	100	0.10	1200	
PZ1005U121-1R0TF	120±25%	100	0.12	1000	
PZ1005U221-R80TF	220±25%	100	0.18	800	
PZ1005U601-R45TF	600±25%	100	0.34	450	

PZ1608 TYPE

Part Number	Impedance	Z Test Frequency	Max.DC Resistance	Max.Rated Current	Thickness
Units	Ω	MHz	Ω	mA	mm [inch]
Symbol	Z	Freq.	DCR	I _r	T
PZ1608D300-3R0TF	30±25%	100	0.03	3000	0.8±0.15 [.031±.006]
PZ1608D600-2R0TF	60±25%	100	0.08	2000	
PZ1608D750-1R0TF	75±25%	100	0.15	1000	
PZ1608D121-1R0TF	120±25%	100	0.20	1000	
PZ1608D221-1R0TF	220±25%	100	0.20	1000	
PZ1608D601-R50TF	600±25%	100	0.35	500	
PZ1608E600-1R4TF	60±25%	100	0.10	1400	
PZ1608U100-3R0TF	0~15	100	0.02	3000	
PZ1608U300-3R0TF	30±25%	100	0.03	3000	
PZ1608U600-2R5TF	60±25%	100	0.04	2500	
PZ1608U121-2R0TF	120±25%	100	0.05	2000	
PZ1608U221-1R4TF	220±25%	100	0.10	1400	
PZ1608U331-1R2TF	330±25%	100	0.14	1200	
PZ1608U391-1R0TF	390±25%	100	0.14	1000	
PZ1608U471-1R0TF	470±25%	100	0.20	1000	

SPECIFICATIONS

PZ2012 TYPE

Part Number	Impedance	Z Test Frequency	Max.DC Resistance	Max.Rated Current	Thickness
Units	Ω	MHz	Ω	mA	mm [inch]
Symbol	Z	Freq.	DCR	I _r	T
PZ2012D390-4R0TF	39±25%	100	0.02	4000	0.85±0.2 [.033±.008]
PZ2012D800-3R0TF	80±25%	100	0.04	3000	
PZ2012D121-2R5TF	120±25%	100	0.06	2500	
PZ2012D221-1R5TF	220±25%	100	0.08	1500	
PZ2012D301-1R5TF	300±25%	100	0.12	1500	
PZ2012D471-R80TF	470±25%	100	0.25	800	
PZ2012D601-R80TF	600±25%	100	0.25	800	
PZ2012U300-3R0TF	30±25%	100	0.02	3000	
PZ2012U300-4R0TF	30±25%	100	0.015	4000	
PZ2012U600-3R0TF	60±25%	100	0.025	3000	
PZ2012U121-2R5TF	120±25%	100	0.04	2500	
PZ2012U221-2R0TF	220±25%	100	0.07	2000	
PZ2012U301-1R5TF	300±25%	100	0.10	1500	
PZ2012U421-1R0TF	420±25%	100	0.20	1000	
PZ2012U601-R80TF	600±25%	100	0.25	800	

PZ3216 TYPE

Part Number	Impedance	Z Test Frequency	Max.DC Resistance	Max.Rated Current	Thickness
Units	Ω	MHz	Ω	mA	mm [inch]
Symbol	Z	Freq.	DCR	I _r	T
PZ3216D190-6R0TF	19±25%	100	0.010	6000	0.85±0.2 [.033±.008]
PZ3216D380-5R0TF	38±25%	100	0.015	5000	
PZ3216D600-4R0TF	60±25%	100	0.02	4000	
PZ3216D121-3R0TF	120±25%	100	0.03	3000	
PZ3216D501-2R0TF	500±25%	100	0.07	2000	
PZ3216D601-2R0TF	600±25%	100	0.07	2000	
PZ3216U300-6R0TF	30±25%	100	0.01	6000	
PZ3216U600-4R0TF	60±25%	100	0.025	4000	
PZ3216U121-3R0TF	120±25%	100	0.03	3000	
PZ3216U221-2R0TF	220±25%	100	0.08	2000	
PZ3216U301-2R0TF	300±25%	100	0.10	2000	
PZ3216U391-2R0TF	390±25%	100	0.07	2000	
PZ3216U601-1R5TF	600±25%	100	0.10	1500	
PZ3216U102-R50TF	1000±25%	100	0.30	500	

Note: The thickness of PZ3216 series may be increased to 1.1±0.2 mm when the I_r of product increased.

PZ4516 TYPE

Part Number	Impedance	Z Test Frequency	Max.DC Resistance	Max.Rated Current	Thickness
Units	Ω	MHz	Ω	mA	mm [inch]
Symbol	Z	Freq.	DCR	I _r	T
PZ4516U600-6R0TF	60±25%	100	0.01	6000	1.6±0.2 [.063±.008]
PZ4516U720-6R0TF	72±25%	100	0.01	6000	
PZ4516U181-3R0TF	180±25%	100	0.025	3000	
PZ4516U471-2R0TF	470±25%	100	0.05	2000	
PZ4516U102-1R5TF	1000±25%	100	0.09	1500	

※: Products with other electrical characteristics can be provided upon customer's request. Please contact your local sales.

TYPICAL ELECTRICAL CHARACTERISTICS

D, E, U Material Comparison

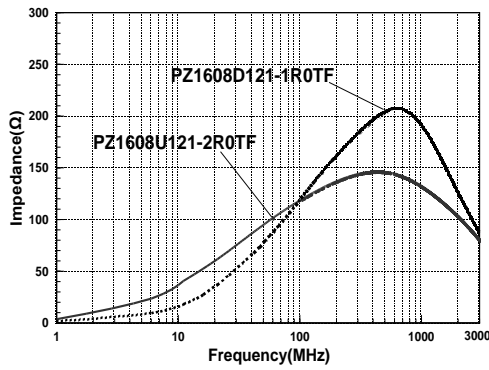

Rated Current

When operating temperatures exceed +85°C, derating of current is necessary for chip ferrite beads for which rated current is 1000mA and over. Please apply the derating curve shown in chart according to the operating temperature.

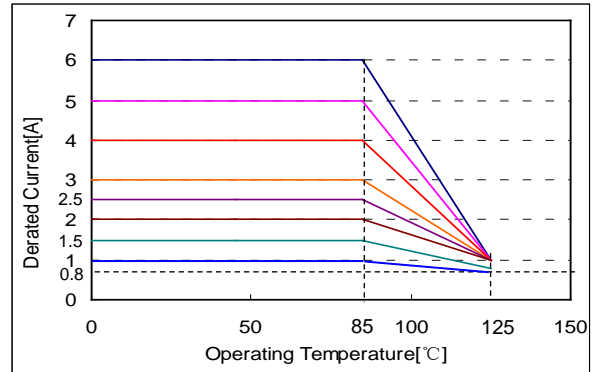

DETAIL ELECTRICAL CHARACTERISTICS

PZ0603 TYPE

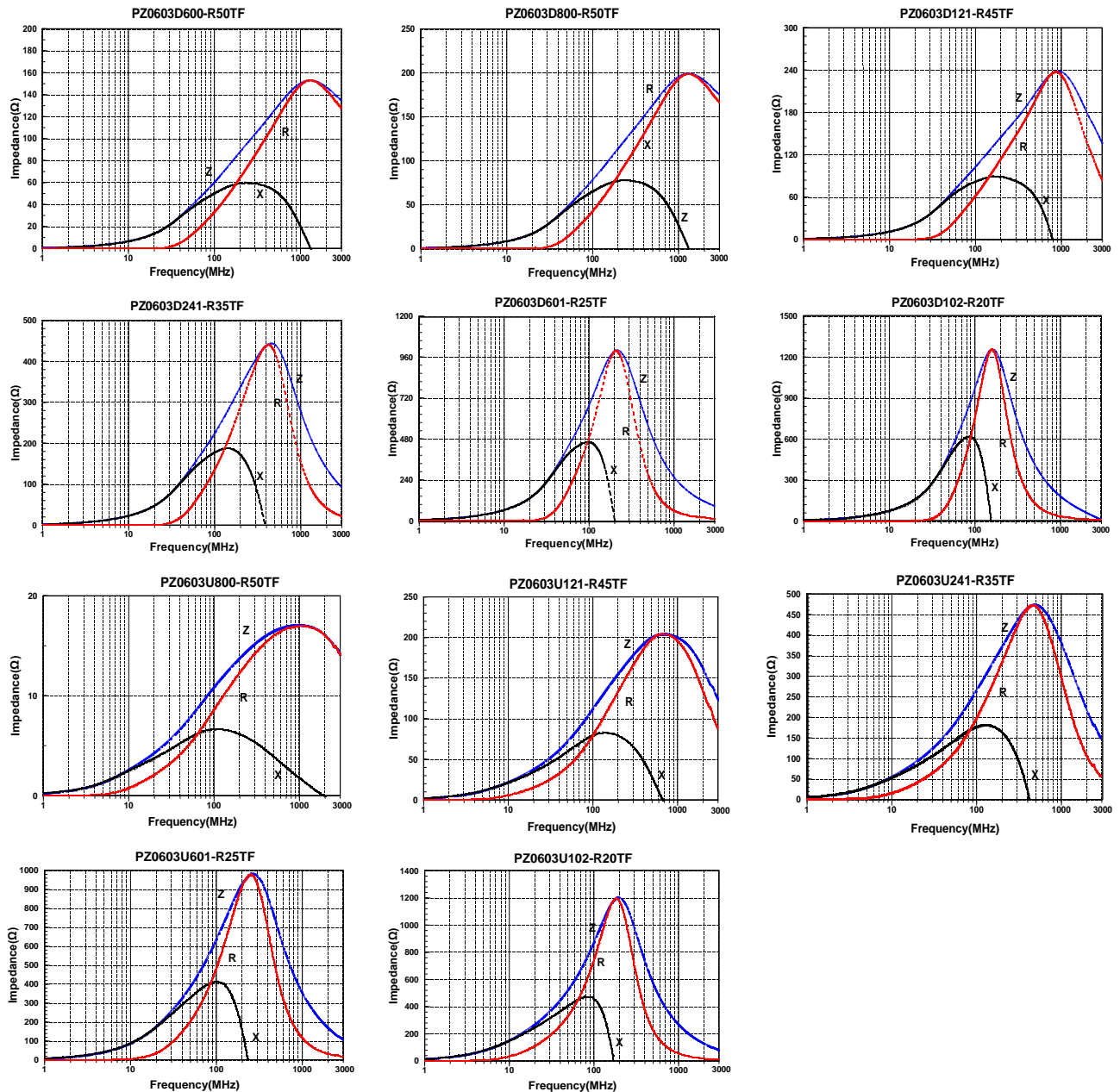

DETAIL ELECTRICAL CHARACTERISTICS

PZ1005 TYPE

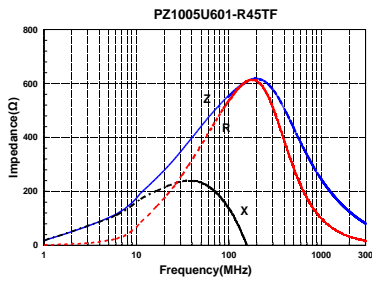
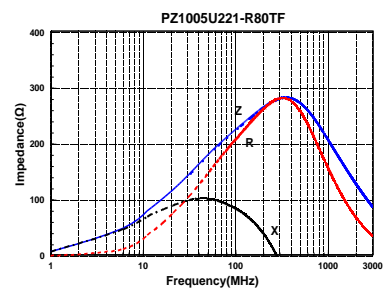
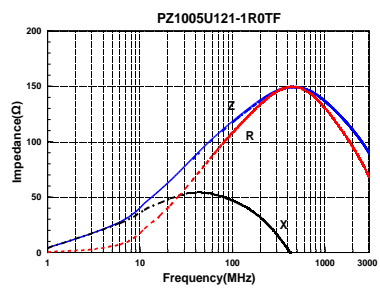
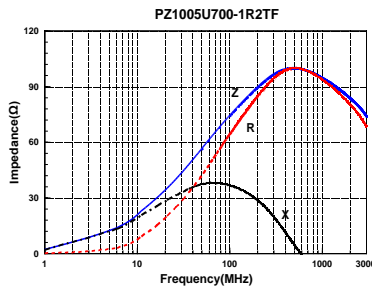
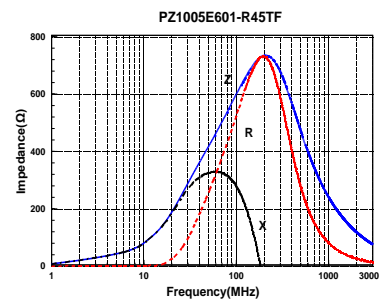
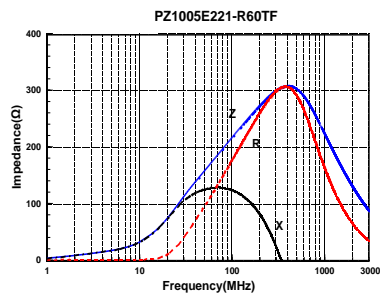
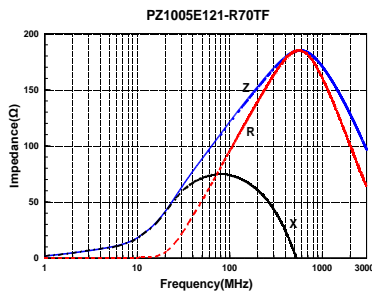
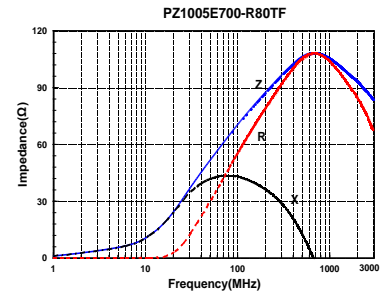
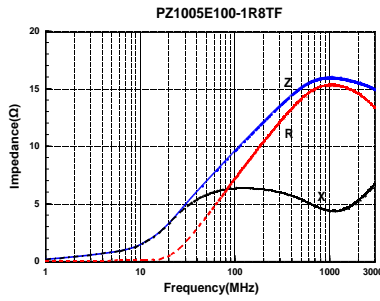
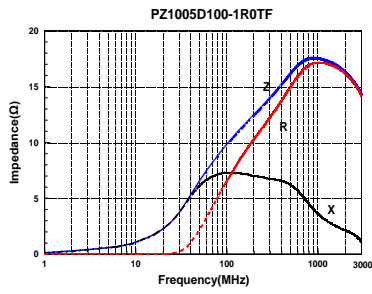

PZ1608 TYPE

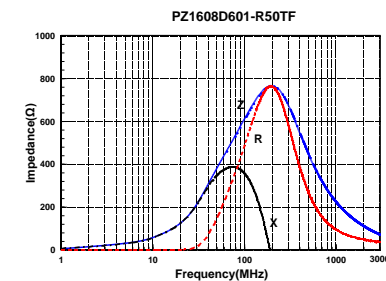
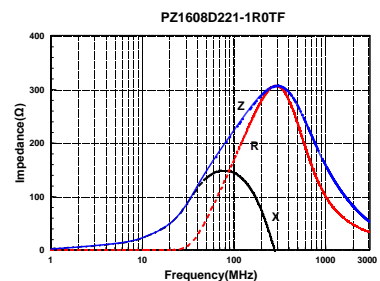
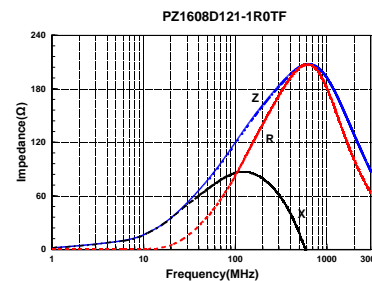
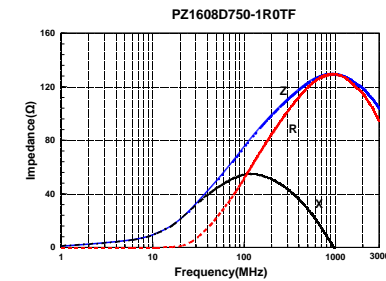
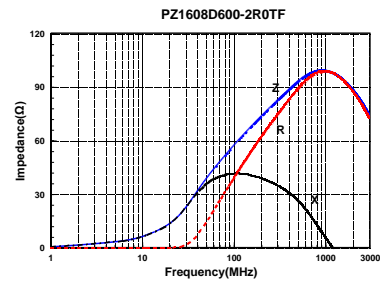
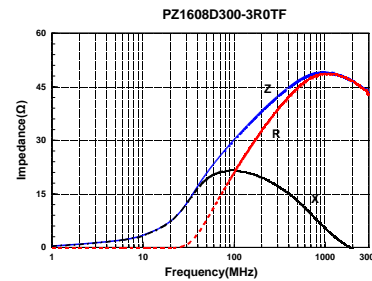

DETAIL ELECTRICAL CHARACTERISTICS

PZ1608 TYPE

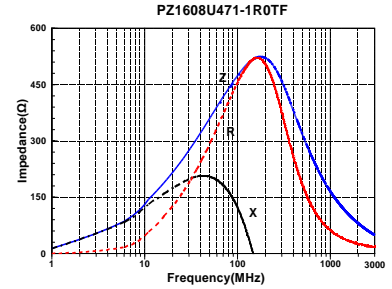
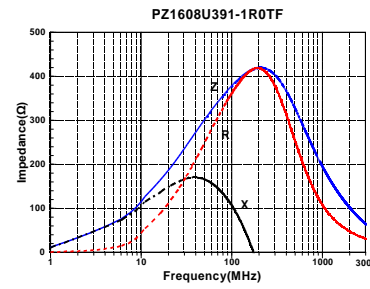
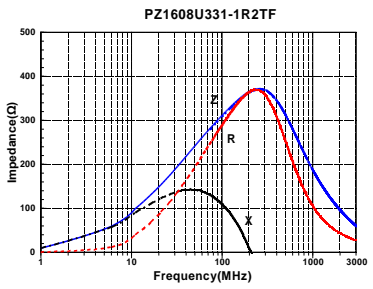
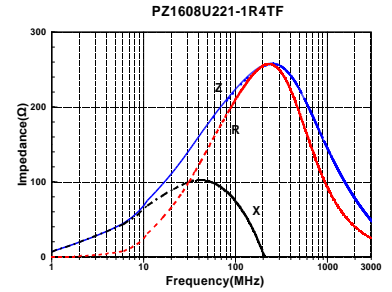
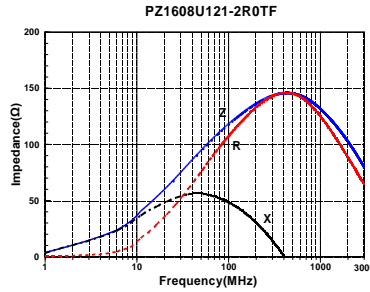
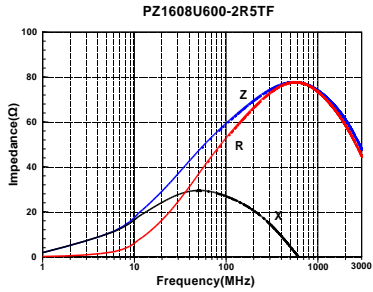
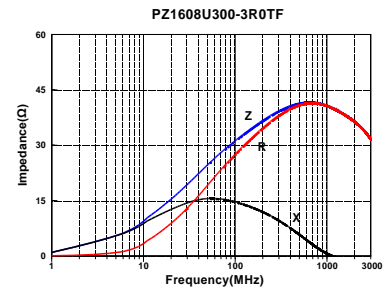
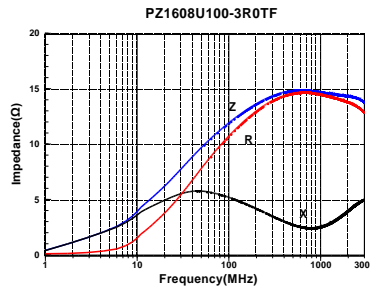
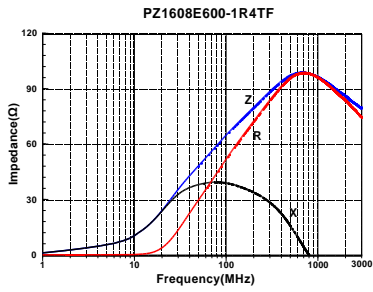

PZ2012 TYPE

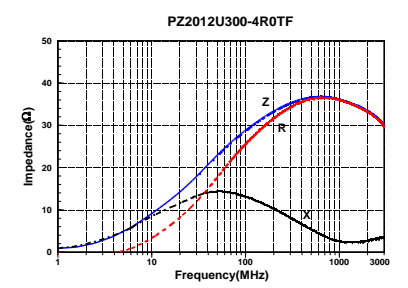
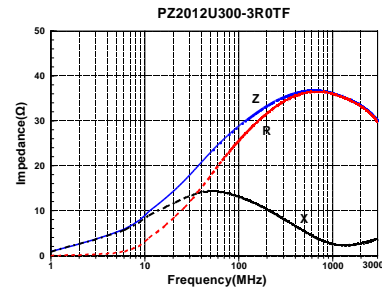
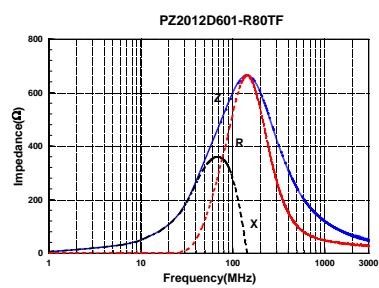
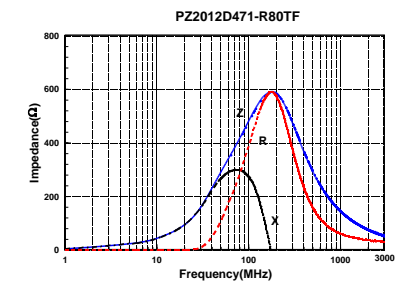
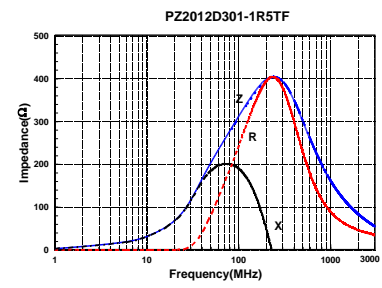
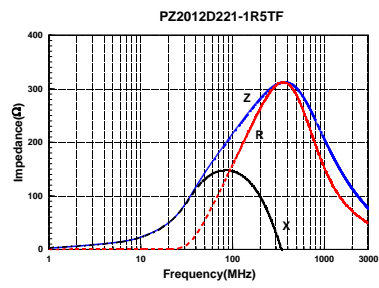
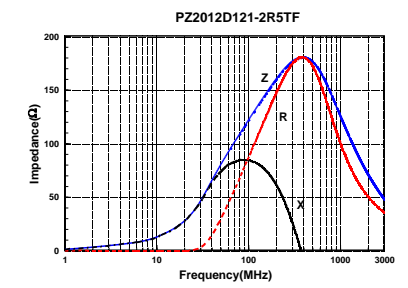
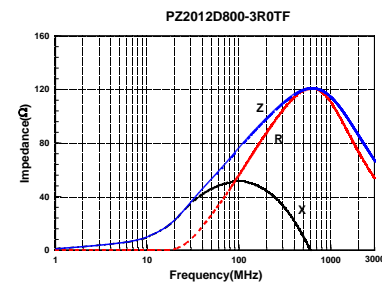
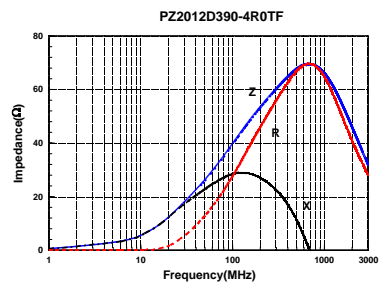

DETAIL ELECTRICAL CHARACTERISTICS

PZ2012 TYPE

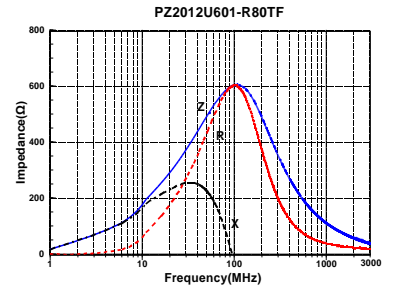
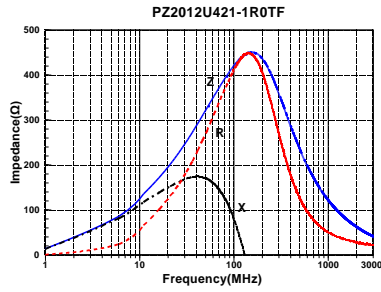
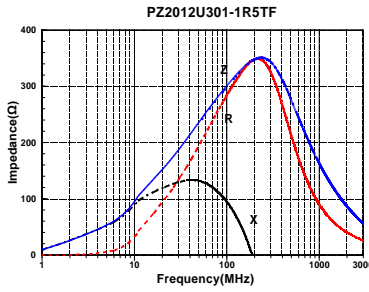
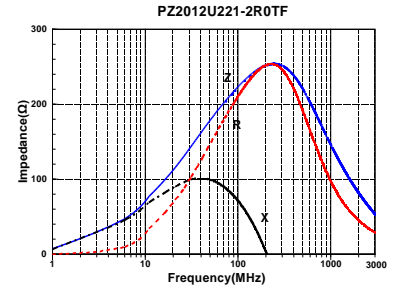
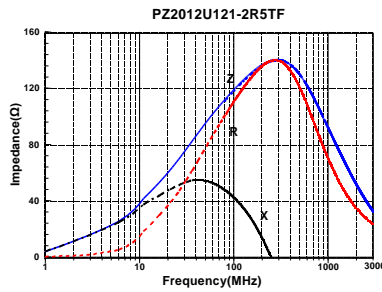
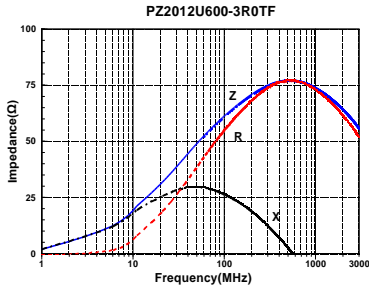

PZ3216 TYPE

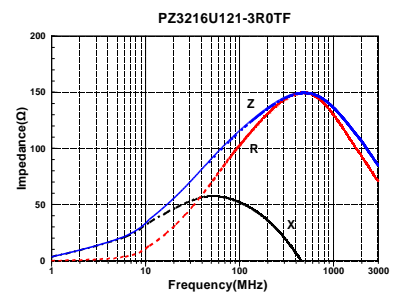
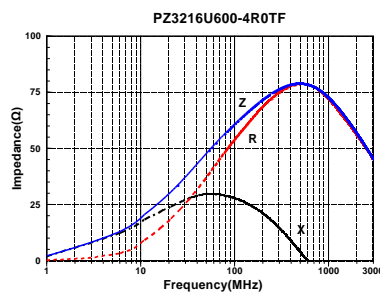
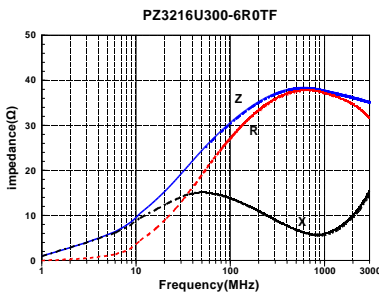
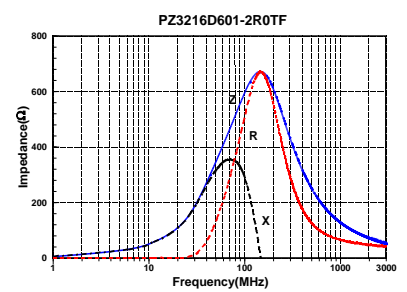
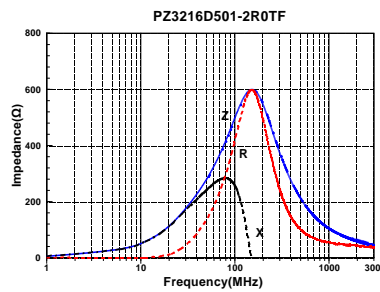
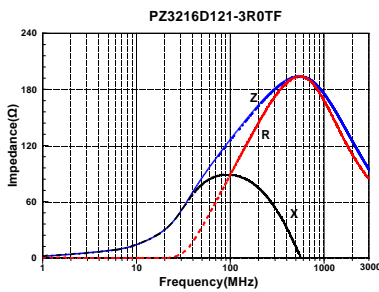
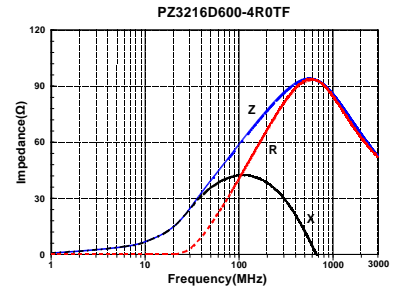
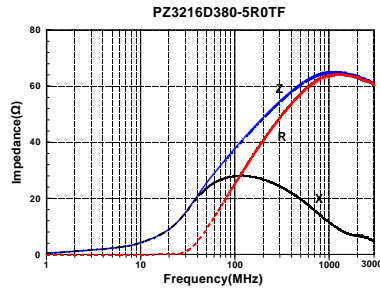
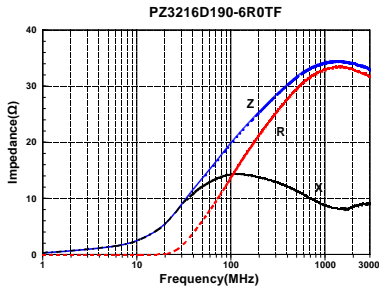

DETAIL ELECTRICAL CHARACTERISTICS

PZ3216 TYPE

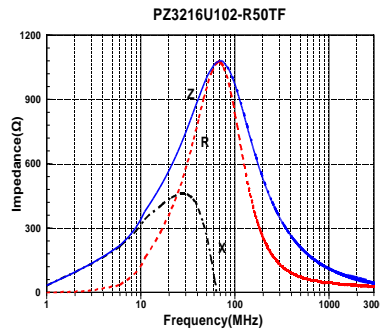
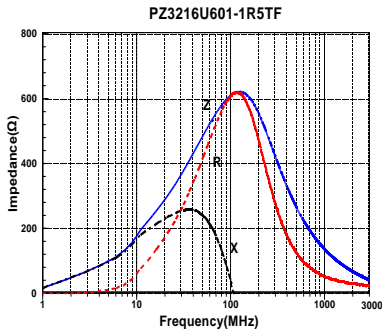
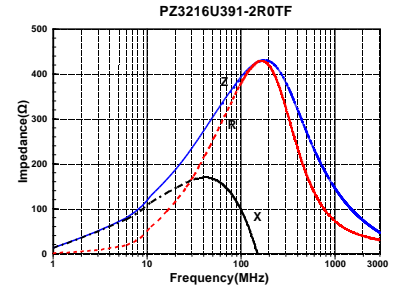
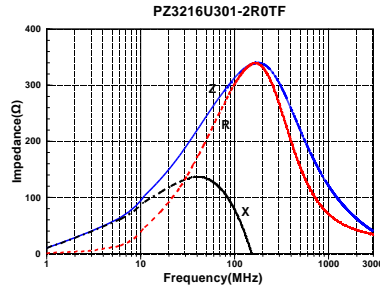
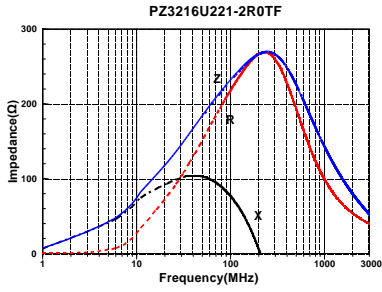

PZ4516 TYPE

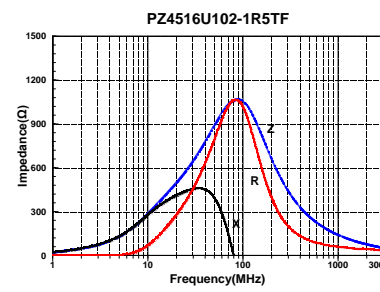
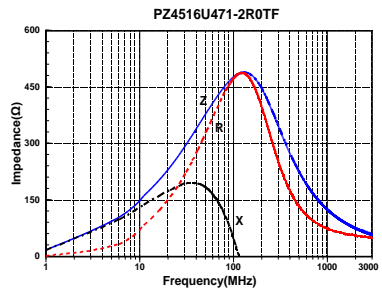
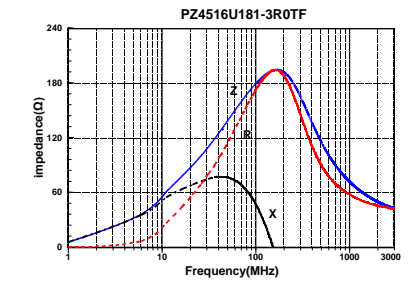
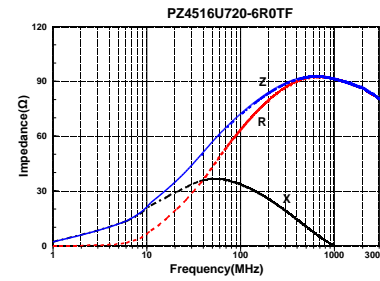
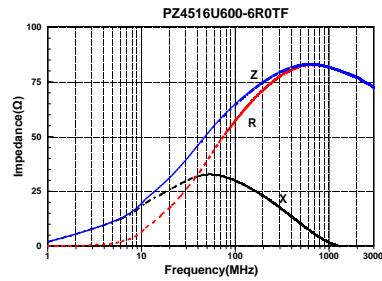

X-ON Electronics

Largest Supplier of Electrical and Electronic Components

Click to view similar products for [Ferrite Beads](#) category:

Click to view products by [Sunlord](#) manufacturer:

Other Similar products are found below :

[CZB1EGTTP700P](#) [CZB1JGTTD152P](#) [CZB1JGTTD601P](#) [CZB2AFTTD800P](#) [CZB2AGTTD121P](#) [CZB2AGTTD601P](#) [CZB2BFTTE600P](#)
[PE-0402FB121ST](#) [NCB0603R301TR050F](#) [NCB0805A320TR050F](#) [NCB-H1206B680TR300F](#) [SMB2.5-1TR](#) [SMB2.5R-2](#) [CZB1EGTTP121P](#)
[CZB1JGTTD102P](#) [CZB1JGTTD121P](#) [CZB1JGTTD221P](#) [CZB2AGTTD301P](#) [CZB2BFTTE301P](#) [CZB2BFTTE601P](#) [4221R-1](#) [4221R-2](#)
[432703041971](#) [EMI0805R-2000](#) [EMI0805R-600](#) [SBY100505T-100Y-N](#) [NCB-GH0402D121TR060F](#) [NCB-H1812D125TR150F](#)
[CZB2AGTTD102P](#) [NCB0402P301TR005F](#) [NCB0603R152TR030F](#) [NCB0805A121TR050F](#) [NCB3312K900TR500F](#) [NCB-](#)
[H0805A102TR150F](#) [NCB-H0805A221TR300F](#) [NCB-H1806E181TR300F](#) [NCB0402P300TR030F](#) [NCB0805A102TR040F](#)
[NCB1806E151TR020F](#) [NCB-H0603R121TR300F](#) [NCB-H0805A220TR600F](#) [NCB-H0805A390TR400F](#) [NCB-H1206B121TR300F](#) [NCB-](#)
[H1206B601TR200F](#) [CIM21J252NE](#) [EMI0805R-220](#) [74279250](#) [7427924](#) [CZB1JGTTD202P](#) [ABUPDE160808121Y00](#)