

SPECIFICATIONS

Customer	
Product Name	Multi-layer Chip Ceramic Inductor
Sunlord Part Number	SDCL1608-D Series
Customer Part Number	

New Released, Revised]

SPEC No.: **SDCL06130000**

【This SPEC is total 9 pages including specifications and appendix.】

【ROHS Compliant Parts】

Approved By	Checked By	Issued By

Shenzhen Sunlord Electronics Co., Ltd.

Address: Sunlord Industrial Park, Dafuyuan Industrial Zone, Baoan, Shenzhen, China 518110
 Tel: 0086-755-29832660 Fax: 0086-755-82269029 E-Mail: sunlord@sunlordinc.com

【For Customer approval Only】

Date: _____

Qualification Status: Full Restricted Rejected

Approved By	Verified By	Re-checked By	Checked By

Comments:

【Version change history】

Rev.	Effective Date	Changed Contents	Change Reasons	Approved By
01	/	New release	/	Hai Guo

1. Scope

This specification applies to SDCL1608-D series of multi-layer ceramic chip inductor.

2. Product Description and Identification (Part Number)

- 1) Description
SDCL1608 series of multi-layer ceramic chip inductor.
- 2) Product Identification (Part Number)

SDCL 1608 C XXX □ ◎ D E
 ① ② ③ ④ ⑤ ⑥ ⑦ ⑧

①	Type
SDCL	Chip Ceramic Inductor

②	External Dimensions (L X W) (mm)
1608 [0603]	1.6 X 0.8

③	Material Code
	C

④	Nominal Inductance
Example	Nominal Value
3N9	3.9nH
10N	10nH
R10	100nH

⑤	Inductance Tolerance
C	±0.2nH
S	±0.3nH
H	±3%
J	±5%
K	±10%

⑥	Packing
T	Tape Carrier Package

⑦	Internal Code
	D

⑧	HSF Products
	Hazardous Substance Free Products

3. Electrical Characteristics

Please refer to **Appendix A** (Page 9).

- 1) Operating and storage temperature range (individual chip without packing):-40°C ~ +85°C.
- 2) Storage temperature range (packaging conditions): -10°C~+40°C and RH 70% (Max.)

4. Shape and Dimensions

- 1) Dimensions and recommended PCB pattern for reflow soldering: See **Fig.4-1**, **Fig.4-2** and **Table 4-1**.
- 2) Structure: See **Fig. 4-3** and **Fig. 4-4**.

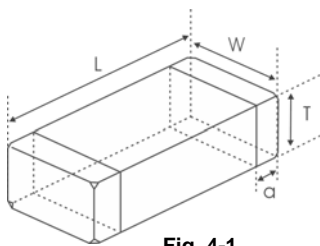

Fig. 4-1

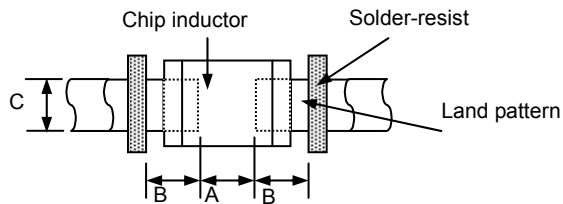

Fig. 4-2

[Table 4-1]

Unit: mm [inch]

Type	L	W	T	a	A	B	C
1608 [0603]	1.60±0.15 [0.063±0.006]	0.8±0.15 [0.031±0.006]	0.8±0.15 [0.031±0.006]	0.3±0.2 [0.012±0.008]	0.60~0.80	0.60~0.80	0.60~0.80
	1.65±0.15 [.065±.006]						

Note: The details of different length for different products see **Appendix A**: Electrical Characteristics.

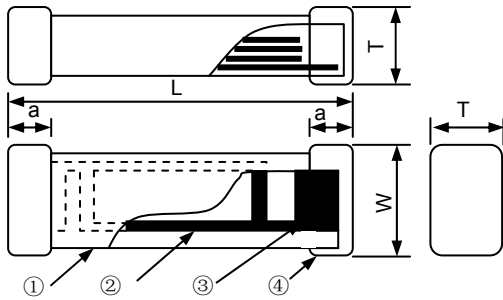

Fig. 4-3

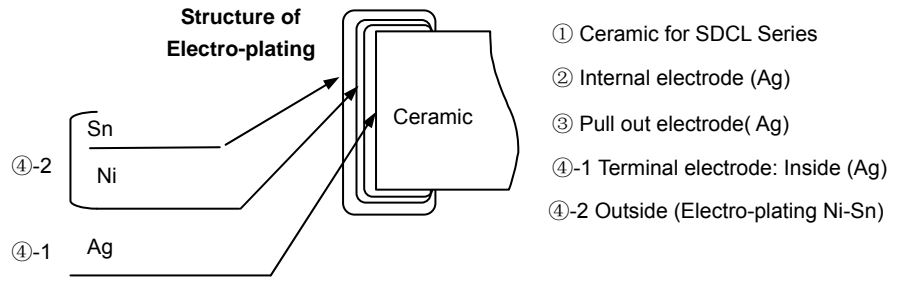

Fig. 4-4

- ① Ceramic for SDCL Series
- ② Internal electrode (Ag)
- ③ Pull out electrode (Ag)
- ④-1 Terminal electrode: Inside (Ag)
- ④-2 Outside (Electro-plating Ni-Sn)

3) Material Information: See Table 4-2

[Table 4-2]

Code	Part Name	Material Name
①	Ceramic Body	Ceramic Powder
②	Inner Coils	Silver Paste
③	Pull-out Electrode (Ag)	Silver Paste
④-1	Terminal Electrode: Inside Ag	Termination Silver Composition
④-2	Electro-Plating: Ni/Sn plating	Plating Chemicals

5. Test and Measurement Procedures

5.1 Test Conditions

Unless otherwise specified, the standard atmospheric conditions for measurement/test as:

- a. Ambient Temperature: 20±15℃
- b. Relative Humidity: 65±20%
- c. Air Pressure: 86kPa to 106kPa

If any doubt on the results, measurements/tests should be made within the following limits:

- a. Ambient Temperature: 20±2℃
- b. Relative Humidity: 65±5%
- c. Air Pressure: 86kPa to 106kPa

5.2 Visual Examination

- a. Inspection Equipment: 20× magnifier

5.3 Electrical Test

5.3.1 DC Resistance (DCR)

- a. Refer to **Appendix A**.
- b. Test equipment (Analyzer): High Accuracy Milliohmmeter-HP4338B or equivalent.

5.3.2 Inductance (L)

- a. Refer to **Appendix A**.
- b. Test equipment: High Accuracy RF Impedance /Material Analyzer-E4991A+HP16192A(SDCL1608-D~SDCL2010-D), HP16197A(SDCL0603-D)or equivalent.
- c. Test signal: -20dBm or 50mV
- d. Test frequency refers to Appendix A.

5.3.3 Q Factor (Q)

- a. Refer to **Appendix A**.
- b. Test equipment: High Accuracy RF Impedance /Material Analyzer-E4991A+HP16192A(SDCL1608-D~SDCL2010-D), HP16197A(SDCL0603-D)or equivalent.
- c. Test signal: -20dBm or 50mV
- d. Test frequency refers to Appendix A.

5.3.4 Self-Resonant Frequency (SRF)

- a. Refer to **Appendix A**.
- b. Test equipment: High Accuracy RF Impedance /Material Analyzer- E4991A+HP16192A(SDCL1608-D~SDCL2010-D), HP16197A (SDCL0603-D) or Agilent E5071C Network analyzer(when SRF > 3GHz).
- c. Test signal: -20dBm or 50 mV

5.3.5 Rated Current

- a. Refer to **Appendix A**.
- b. Test equipment (see Fig. 5.3.5-1): Electric Power, Electric current meter, Thermometer.
- c. Measurement method (see Fig. 5.3.5-1):
 1. Set test current to be 0mA.
 2. Measure initial temperature of chip surface.
 3. Gradually increase voltage and measure chip temperature for corresponding current.
- d. Definition of Rated Current(Ir): Ir is direct electric current as chip surface temperature rose just 20℃ against chip initial surface temperature(Ta) (see Fig. 5.3.5-2).

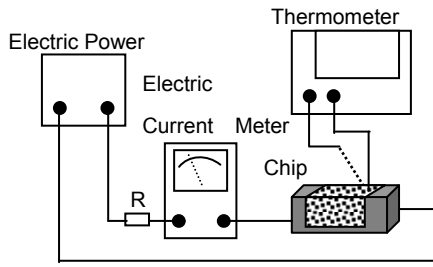

Fig. 5.3.5-1

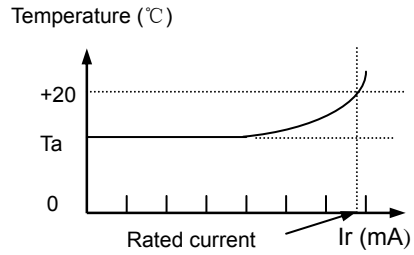
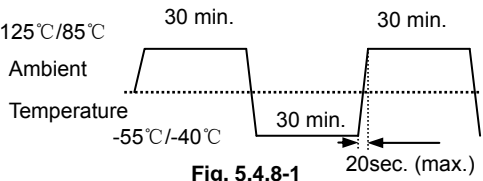

Fig. 5.3.5-2

5.4 Reliability Test

Items	Requirements	Test Methods and Remarks								
5.4.1 Terminal Strength	<p>No removal or split of the termination or other defects shall occur.</p> <p>Fig.5.4.1-1</p>	<ol style="list-style-type: none"> Solder the inductor to the testing jig (glass epoxy board shown in Fig. 5.4.1-1) using leadfree solder. Then apply a force in the direction of the arrow. 5N force for 1608 series. Keep time: 10±1s Speed: 1.0mm/s. 								
5.4.2 Resistance to Flexure	<p>No visible mechanical damage.</p> <p>Unit: mm [inch]</p> <table border="1"> <thead> <tr> <th>Type</th> <th>a</th> <th>b</th> <th>c</th> </tr> </thead> <tbody> <tr> <td>1608[0603]</td> <td>1.0</td> <td>3.0</td> <td>1.2</td> </tr> </tbody> </table> <p>Fig. 5.4.2-1</p>	Type	a	b	c	1608[0603]	1.0	3.0	1.2	<ol style="list-style-type: none"> Solder the inductor to the test jig (glass epoxy board shown in Fig. 5.4.2-1) Using a leadfree solder. Then apply a force in the direction shown Fig. 5.4.2-2. Flexure: 2mm. Pressurizing Speed: 0.5mm/sec. Keep time: 30 sec. <p>Fig. 5.4.2-2</p>
Type	a	b	c							
1608[0603]	1.0	3.0	1.2							
5.4.3 Vibration	<ol style="list-style-type: none"> No visible mechanical damage. Inductance change: Within ±10%. Q factor change: Within ±20%. <p>Fig. 5.4.3-1</p>	<ol style="list-style-type: none"> Solder the inductor to the testing jig (glass epoxy board shown in Fig. 5.4.3-1) using leadfree solder. The inductor shall be subjected to a simple harmonic motion having total amplitude of 1.5mm, the frequency being varied uniformly between the approximate limits of 10 and 55 Hz. The frequency range from 10 to 55 Hz and return to 10 Hz shall be traversed in approximately 1 minute. This motion shall be applied for a period of 2 hours in each 3 mutually perpendicular directions (total of 6 hours). 								
5.4.4 Dropping	<ol style="list-style-type: none"> No visible mechanical damage. Inductance change: Within ±10%. Q factor change: Within ±20%. 	Drop chip inductor 10 times on a concrete floor from a height of 100 cm.								
5.4.5 Temperature	Inductance change should be within ±10% of initial value measuring at 20°C.	Temperature range: SDCL0603-D: -55°C to +125°C, SDCL1608-D/SDCL2012-D: -40°C to +85°C Reference temperature: 20°C								
5.4.6 Solderability	<ol style="list-style-type: none"> No visible mechanical damage. Wetting shall exceed 75% coverage for 0603 series; exceed 95% for others 	<ol style="list-style-type: none"> Solder temperature: 240±2°C Duration: 3 sec. Solder: Sn/3.0Ag/0.5Cu. Flux: 25% Resin and 75% ethanol in weight. 								
5.4.7 Resistance to Soldering Heat	<ol style="list-style-type: none"> No visible mechanical damage. Wetting shall exceed 75% coverage for 0603 series; exceed 95% coverage for others Inductance change: Within ±10%. Q factor change: Within ±20%. 	<ol style="list-style-type: none"> Solder temperature: 260±3°C Duration: 5 sec. Solder: Sn/3.0Ag/0.5Cu. Flux: 25% Resin and 75% ethanol in weight. The chip shall be stabilized at normal condition for 1~2 hours before measuring. 								

<p>5.4.8 Thermal Shock</p>	<p>① No mechanical damage. ② Inductance change: Within $\pm 10\%$. ③ Q factor change: Within $\pm 20\%$.</p>  <p>Fig. 5.4.8-1</p>	<p>① Temperature, Time: (See Fig. 5.4.8-1) SDCL0603-D: -55°C for 30 ± 3 min \rightarrow 125°C for 30 ± 3 min, SDCL1608-D/SDCL2012-D: -40°C for 30 ± 3 min \rightarrow 85°C for 30 ± 3 min. ② Transforming interval: Max. 20 sec. ③ Tested cycle: 100 cycles. ④ The chip shall be stabilized at normal condition for 1~2 hours before measuring.</p>
<p>5.4.9 Resistance to Low Temperature</p>	<p>① No mechanical damage. ② Inductance change: Within $\pm 10\%$. ③ Q factor change: Within $\pm 20\%$.</p>	<p>① Temperature: SDCL0603-D: $-55\pm 2^{\circ}\text{C}$, SDCL1608-D/SDCL2012-D: $-40\pm 2^{\circ}\text{C}$. ② Duration: 1000^{+24} hours. ③ The chip shall be stabilized at normal condition for 1~2 hours before measuring.</p>
<p>5.4.10 Resistance to High Temperature</p>	<p>① No mechanical damage. ② Inductance change: Within $\pm 10\%$. ③ Q factor change: Within $\pm 20\%$.</p>	<p>① Temperature: SDCL0603-D: $125\pm 2^{\circ}\text{C}$, SDCL1608-D/SDCL2012-D: $85\pm 2^{\circ}\text{C}$. ② Duration: 1000^{+24} hours. ③ The chip shall be stabilized at normal condition for 1~2 hours before measuring.</p>
<p>5.4.11 Damp Heat (Steady States)</p>	<p>① No visible mechanical damage. ② Inductance change: Within $\pm 10\%$. ③ Q factor change: Within $\pm 20\%$.</p>	<p>① Temperature: $60\pm 2^{\circ}\text{C}$ ② Humidity: 90% to 95% RH. ③ Duration: 1000^{+24} hours. ④ The chip shall be stabilized at normal condition for 1~2 hours before measuring.</p>
<p>5.4.12 Loading Under Damp Heat</p>	<p>① No visible mechanical damage. ② Inductance change: Within $\pm 10\%$. ③ Q factor change: Within $\pm 20\%$.</p>	<p>① Temperature: $60\pm 2^{\circ}\text{C}$ ② Humidity: 90% to 95% RH. ③ Duration: 1000^{+24} hours. ④ Applied current: Rated current. ⑤ The chip shall be stabilized at normal condition for 1~2 hours before measuring.</p>
<p>5.4.13 Loading at High Temperature (Life Test)</p>	<p>① No visible mechanical damage. ② Inductance change: Within $\pm 10\%$. ③ Q factor change: Within $\pm 20\%$.</p>	<p>① Temperature: SDCL0603-D: $125\pm 2^{\circ}\text{C}$, SDCL1608-D/SDCL2012-D: $85\pm 2^{\circ}\text{C}$ ② Duration: 1000^{+24} hours. ③ Applied current: Rated current. ④ The chip shall be stabilized at normal condition for 1~2 hours before measuring.</p>

6. Packaging, Storage

6.1 Packaging

Tape Carrier Packaging:

Packaging code: T

- a. Tape carrier packaging are specified in attached figure Fig.6.1-1~3
- b. Tape carrier packaging quantity please see the following table:

Type	1608[0603]
T(mm)	0.8 \pm 0.15
Tape	Paper Tape
Quantity	4K

(1) Taping Drawings (Unit: mm)

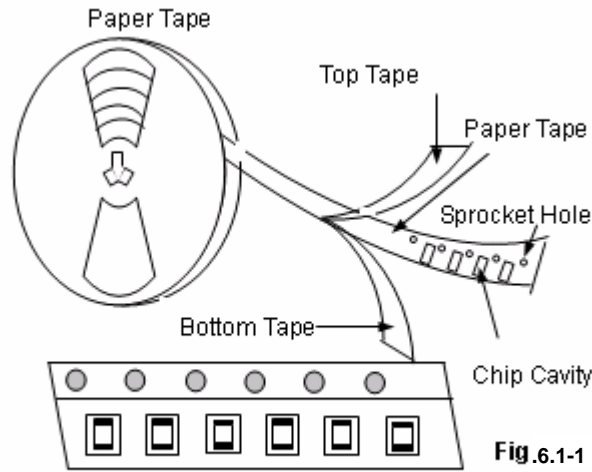

Remark: The sprocket holes are to the right as the tape is pulled toward the user.

(2) Taping Dimensions (Unit: mm)

Sprocket Hole $\Phi 1.5 (+0.1, 0)$

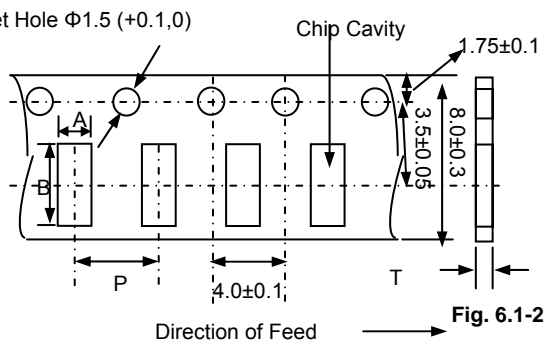

Paper Tape

Type	A	B	P	T max
1608[0603]	1.0 ± 0.2	1.8 ± 0.2	4.0 ± 0.1	1.1

(3) Reel Dimensions (Unit: mm)

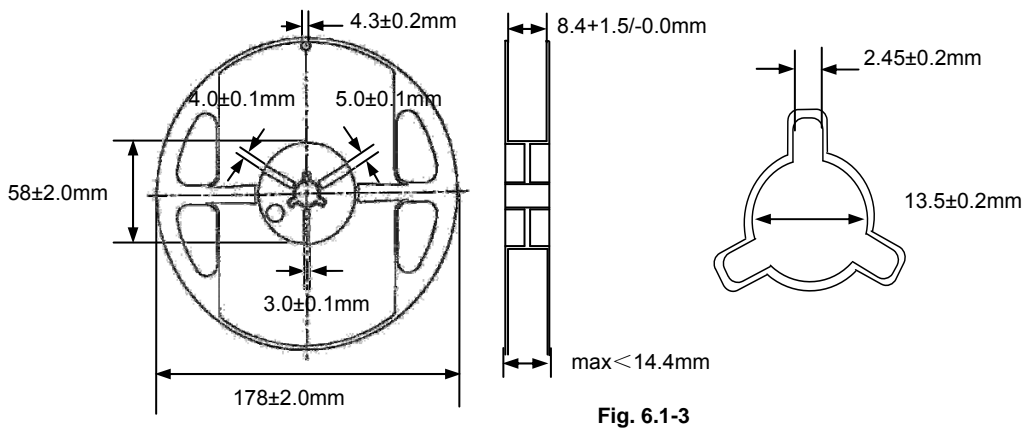

6.2 Storage

- a. The solderability of the external electrode may be deteriorated if packages are stored where they are exposed to high humidity. Package must be stored at 40°C or less and 70% RH or less.
- b. The solderability of the external electrode may be deteriorated if packages are stored where they are exposed to dust or harmful gas (e.g. HCl, sulfurous gas of H_2S).
- c. Packaging material may be deformed if package are stored where they are exposed to heat of direct sunlight.
- d. Solderability specified in **Clause 5.4.6** shall be guaranteed for 12 months from the date of delivery on condition that they are stored at the environment specified in **Clause 3**. For those parts, which passed more than 12 months shall be checked solder-ability before use.

7. Recommended Soldering Technologies

7.1 Re-flowing Profile:

- △ Preheat condition: 150 ~200°C/60~120sec.
- △ Allowed time above 217°C: 60~90sec.
- △ Max temp: 260°C
- △ Max time at max temp: 10sec.
- △ Solder paste: Sn/3.0Ag/0.5Cu
- △ Allowed Reflow time: 2x max

[Note: The reflow profile in the above table is only for qualification and is not meant to specify board assembly profiles. Actual board assembly profiles must be based on the customer's specific board design, solder paste and process, and should not exceed the parameters as the Reflow profile shows.]

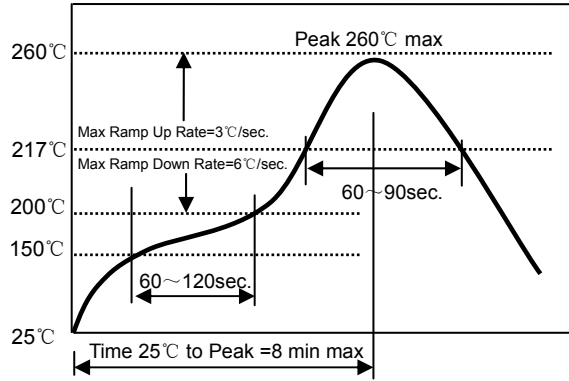

7.2 Iron Soldering Profile.

- △ Iron soldering power: Max.30W.
- △ Pre-heating: 150 °C / 60 sec.
- △ Soldering Tip temperature: 350°C Max.
- △ Soldering time: 3sec Max.
- △ Solder paste: Sn/3.0Ag/0.5Cu.
- △ Max.1 times for iron soldering.

[Note: Take care not to apply the tip of the soldering iron to the terminal electrodes.]

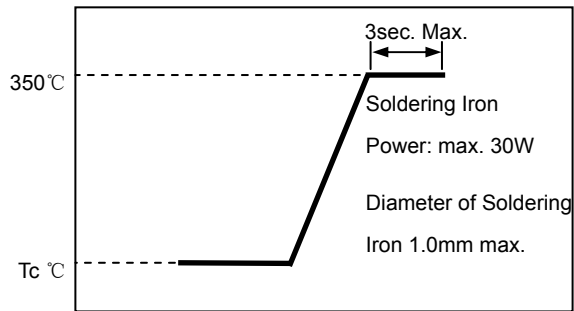

8. Supplier Information

- a) Supplier:
Shenzhen Sunlord Electronics Co., Ltd.
- b) Manufacturer:
Shenzhen Sunlord Electronics Co., Ltd.
- c) Manufacturing Address:
Sunlord Industrial Park, Dafuyuan Industrial Zone, Guanlan, Shenzhen, China 518110

Appendix A: Electrical Characteristics (SDCL-D Series of Inductors)

SDCL1608-D Series of Inductors

Part Number	L (nH)	Q Min.	L, Q Test. Freq (MHz)	Q (Typ.) Freq. (MHz)			S.R.F (MHz) Min	DCR (Ω) Max.	I _r (mA) Max.	Thickness (mm) [inch]
				100	800	1000				
SDCL1608C1N0□TDF	1.0	8	100	13	70	80	10000	0.05	500	0.8±0.15 [.03±0.006]
SDCL1608C1N2□TDF	1.2	8	100	13	60	70	10000	0.05	500	
SDCL1608C1N5□TDF	1.5	8	100	13	47	68	6000	0.10	500	
SDCL1608C1N8□TDF	1.8	8	100	13	45	61	6000	0.10	500	
SDCL1608C2N2□TDF	2.2	8	100	13	45	60	6000	0.10	500	
SDCL1608C2N7□TDF	2.7	10	100	13	44	55	6000	0.12	500	
SDCL1608C3N3□TDF	3.3	10	100	13	43	50	6000	0.15	500	
SDCL1608C3N9□TDF	3.9	10	100	13	43	50	6000	0.16	500	
SDCL1608C4N7□TDF	4.7	10	100	13	43	50	6000	0.20	500	
SDCL1608C5N6□TDF	5.6	10	100	14	42	48	5000	0.25	500	
SDCL1608C6N8□TDF	6.8	10	100	14	43	50	5000	0.30	500	
SDCL1608C8N2□TDF	8.2	10	100	14	43	48	4500	0.35	500	
SDCL1608C10N□TDF	10	12	100	15	45	50	3500	0.40	300	
SDCL1608C12N□TDF	12	12	100	18	48	50	3000	0.45	300	
SDCL1608C15N□TDF	15	12	100	18	48	50	2300	0.50	300	
SDCL1608C18N□TDF	18	12	100	16	48	51	2200	0.55	300	
SDCL1608C22N□TDF	22	12	100	16	45	48	2000	0.60	300	
SDCL1608C27N□TDF	27	12	100	16	45	45	1700	0.65	300	
SDCL1608C33N□TDF	33	12	100	16	45	41	1500	0.70	300	
SDCL1608C39N□TDF	39	12	100	17	40	48	1400	0.70	300	
SDCL1608C47N□TDF	47	12	100	17	35	35	1200	0.70	300	
SDCL1608C56N□TDF	56	12	100	17	35	30	1100	0.75	300	
SDCL1608C68N□TDF	68	12	100	17	30	20	900	0.85	300	
SDCL1608C82N□TDF	82	8	100	15	22	-	800	1.00	300	
SDCL1608CR10□TDF	100	8	100	15	16	-	700	1.20	300	
SDCL1608CR12□TDF*	120	8	50	15	-	-	600	1.40	200	
SDCL1608CR15□TDF*	150	8	50	15	-	-	500	1.60	200	
SDCL1608CR18□TDF*	180	8	50	15	-	-	400	1.90	200	
SDCL1608CR22□TDF*	220	8	50	15	-	-	350	2.40	200	
SDCL1608CR27□TDF*	270	8	50	16	-	-	350	2.60	150	
SDCL1608CR33□TDF*	330	8	50	16	-	-	350	2.80	150	
SDCL1608CR39□TDF*	390	8	50	16	-	-	300	3.20	150	
SDCL1608CR43□TDF*	430	8	50	16	-	-	280	3.40	150	
SDCL1608CR47□TDF*	470	8	50	15	-	-	250	3.60	150	
SDCL1608CR56□TDF*	560	8	50	15	-	-	250	4.00	100	
SDCL1608CR68□TDF*	680	8	50	15	-	-	200	4.50	100	

※□: Please specify the inductance tolerance: For $L \leq 6.2\text{nH}$, choose $B = \pm 0.1\text{nH}$, $C = \pm 0.2\text{nH}$ or $S = \pm 0.3\text{nH}$; For $L > 6.2\text{nH}$, choose $H = \pm 3\%$, $J = \pm 5\%$ or $K = \pm 10\%$.

※*: The length: $1.65 \pm 0.15\text{mm}$, for others: $1.60 \pm 0.15\text{mm}$.

X-ON Electronics

Largest Supplier of Electrical and Electronic Components

Click to view similar products for [Fixed Inductors](#) category:

Click to view products by [Sunlord](#) manufacturer:

Other Similar products are found below :

[MLZ1608M6R8WTD25](#) [MLZ1608N6R8LT000](#) [MLZ1608N3R3LTD25](#) [MLZ1608N3R3LT000](#) [MLZ1608N150LT000](#)
[MLZ1608M150WTD25](#) [MLZ1608M3R3WTD25](#) [MLZ1608M3R3WT000](#) [MLZ1608M150WT000](#) [MLZ1608A1R5WT000](#)
[MLZ1608N1R5LT000](#) [B82432C1333K000](#) [PCMB053T-1R0MS](#) [PCMB053T-1R5MS](#) [PCMB104T-1R5MS](#) [CR32NP-100KC](#) [CR32NP-151KC](#) [CR32NP-180KC](#) [CR32NP-181KC](#) [CR32NP-1R5MC](#) [CR32NP-390KC](#) [CR32NP-3R9MC](#) [CR32NP-680KC](#) [CR32NP-820KC](#)
[CR32NP-8R2MC](#) [CR43NP-390KC](#) [CR43NP-560KC](#) [CR43NP-680KC](#) [CR54NP-181KC](#) [CR54NP-470LC](#) [CR54NP-820KC](#) [CR54NP-8R5MC](#)
[MGDQ4-00004-P](#) [MGDU1-00016-P](#) [MHL1ECTTP18NJ](#) [MHL1JCTTD12NJ](#) [PE-51506NL](#) [PE-53601NL](#) [PE-53630NL](#) [PE-53824SNLT](#) [PE-62892NL](#) [PE-92100NL](#) [PG0434.801NLT](#) [PG0936.113NLT](#) [PM06-2N7](#) [PM06-39NJ](#) [HC2LP-R47-R](#) [HC2-R47-R](#) [HC3-2R2-R](#) [HC8-1R2-R](#)