

Chip Temp. Sensing NTC Thermistor – SDNT Series

Operating Temp. : -55°C~+125°C

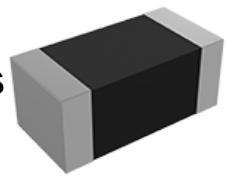

FEATURES

- SMD type suitable for high density mounting
- Series of B constant for various applications
- Excellent solder ability

APPLICATIONS

- Telecommunication equipments such as cellular phone, automobile phone, etc.
- Office automation such as printer, facsimile, word processor, etc.
- Battery, CPU temperature protection.

PRODUCT IDENTIFICATION

<u>SDNT</u> ①	<u>1005</u> ②	<u>X</u> ③	<u>103</u> ④	<u>F</u> ⑤	<u>3380</u> ⑥	<u>F</u> ⑦	<u>T</u> ⑧	<u>F</u> ⑨
①	②		③		④		⑤	
Type		External Dimensions (LxW) (mm)		Internal Code				
SDNT	Chip NTC Thermistor		0603 [0201]	0.6×0.3	X			
			1005 [0402]	1.0×0.5	C			
			1608 [0603]	1.6×0.8				
			2012 [0805]	2.0×1.25				
④		⑤		⑥		⑦		
Zero-power Resistance		Tolerance of Resistance		B Constant (25-50°C)				
Example	Nominal Value		F	±1%	Example	Nominal Value		
472	4.7kΩ		H	±3%	3380	3380K		
103	10kΩ		J	±5%	4250	4250K		
			K	±10%				
⑦		⑧		⑨				
Tolerance of B Constant		Packing		Hazardous Substance		Free Products		
F	±1%		T	Tape & Reel		F		
H	±3%							

SHAPE AND DIMENSIONS

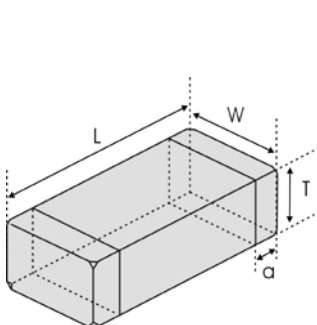

Unit: mm [inch]

Type	L	W	T	a
SDNT0603 [0201]	0.6±0.05 [.024±.002]	0.3±0.05 [.012±.002]	0.3±0.05 [.012±.002]	0.15±0.05 [.006±.002]
SDNT1005 [0402]	1.0±0.15 [.039±.006]	0.5±0.15 [.020±.006]	0.5±0.15 [.020±.006]	0.25±0.1 [.010±.004]
SDNT1608 [0603]	1.6±0.15 [.063±.006]	0.8±0.15 [.031±.006]	0.8±0.15 [.031±.006]	0.3±0.2 [.012±.008]
SDNT2012 [0805]	2.0±0.2 [.079±.008]	1.25±0.2 [.049±.008]	0.85±0.2 [.033±.008]	0.5±0.3 [.020±.012]

SPECIFICATIONS

SDNT0603 TYPE

Part Number	Resistance at 25 °C	B Constant (25-50 °C)	Max. Permissive Operating Current (25 °C)	Thermal Time Constant	Dissipation Factor	Rated Electric Power
Units	kΩ	K	mA	sec	mW/°C	mW
Symbol	R25	B25/50	I _{max}	t	C	P
SDNT0603C103□3380◎TF	10	3380	0.31	<3 sec.	1.0	100
SDNT0603C223□3380◎TF	22	3380	0.21			
SDNT0603C473□4050◎TF	47	4050	0.14			
SDNT0603C683□4250◎TF	68	4250	0.12			
SDNT0603C104□4250◎TF	100	4250	0.10			

SDNT1005 TYPE

Part Number	Resistance at 25 °C	B Constant (25-50 °C)	Max. Permissive Operating Current (25 °C)	Thermal Time Constant	Dissipation Factor	Rated Electric Power
Units	kΩ	K	mA	sec	mW/°C	mW
Symbol	R25	B25/50	I _{max}	t	C	P
SDNT1005X682□3950◎TF	6.8	3950	0.38	<3 sec.	1.0	100
SDNT1005X103□3380◎TF	10	3380	0.31			
SDNT1005X103□3950◎TF	10	3950	0.33			
SDNT1005X103□4050◎TF	10	4050	0.33			
SDNT1005X153□3450◎TF	15	3450	0.25			
SDNT1005X223□3950◎TF	22	3950	0.23			
SDNT1005X303□3950◎TF	30	3950	0.15			
SDNT1005X333□3950◎TF	33	3950	0.15			
SDNT1005X473□4050◎TF	47	4050	0.12			
SDNT1005X473□4100◎TF	47	4100	0.12			
SDNT1005X503□4100◎TF	50	4100	0.12			
SDNT1005X683□4150◎TF	68	4150	0.11			
SDNT1005X104□4150◎TF	100	4150	0.1			
SDNT1005X104□4250◎TF	100	4250	0.1			
SDNT1005X154□4150◎TF	150	4150	0.08			
SDNT1005X224□4250◎TF	220	4250	0.06			

SDNT1608 TYPE

Part Number	Resistance at 25 °C	B Constant (25-50 °C)	Max. Permissive Operating Current (25 °C)	Thermal Time Constant	Dissipation Factor	Rated Electric Power
Units	kΩ	K	mA	sec	mW/°C	mW
Symbol	R25	B25/50	I _{max}	t	C	P
SDNT1608X222□3450◎TF	2.2	3450	0.67	<5 sec.	1.0	100
SDNT1608X472□3950◎TF	4.7	3950	0.46			
SDNT1608X502□3950◎TF	5	3950	0.44			
SDNT1608X103□3380◎TF	10	3380	0.31			
SDNT1608X103□3450◎TF	10	3450	0.31			
SDNT1608X103□3950◎TF	10	3950	0.33			
SDNT1608X153□3950◎TF	15	3950	0.25			
SDNT1608X223□3950◎TF	22	3950	0.21			
SDNT1608X223□4050◎TF	22	4050	0.21			

SPECIFICATIONS

SDNT1608 TYPE

Part Number	Resistance at 25°C	B Constant (25-50°C)	Max. Permissible Operating Current (25°C)	Thermal Time Constant	Dissipation Factor	Rated Electric Power
Units	kΩ	K	mA	sec	mW/°C	mW
Symbol	R25	B25/50	I _{max}	t	C	P
SDNT1608X333□4050◎TF	33	4050	0.17	<5 sec.	1.0	100
SDNT1608X473□4050◎TF	47	4050	0.14			
SDNT1608X473□4150◎TF	47	4150	0.14			
SDNT1608X503□4150◎TF	50	4150	0.13			
SDNT1608X683□4150◎TF	68	4150	0.12			
SDNT1608X104□3950◎TF	100	3950	0.1			
SDNT1608X104□4250◎TF	100	4250	0.1			
SDNT1608X124□4250◎TF	120	4250	0.1			
SDNT1608X154□4250◎TF	150	4250	0.08			
SDNT1608X224□4300◎TF	220	4300	0.06			

SDNT2012 TYPE

Part Number	Resistance at 25°C	B Constant (25-50°C)	Max. Permissible Operating Current (25°C)	Thermal Time Constant	Dissipation Factor	Rated Electric Power
Units	kΩ	K	mA	sec	mW/°C	mW
Symbol	R25	B25/50	I _{max}	t	C	P
SDNT2012X472□3950◎TF	4.7	3950	0.65	<5 sec.	2.0	200
SDNT2012X502□3950◎TF	5	3950	0.6			
SDNT2012X103□3450◎TF	10	3450	0.4			
SDNT2012X103□3950◎TF	10	3950	0.44			
SDNT2012X223□4050◎TF	22	4050	0.31			
SDNT2012X333□4050◎TF	33	4050	0.24			
SDNT2012X473□4050◎TF	47	4050	0.2			
SDNT2012X473□4150◎TF	47	4150	0.2			
SDNT2012X503□4150◎TF	50	4150	0.18			
SDNT2012X104□3950◎TF	100	3950	0.14			
SDNT2012X104□4250◎TF	100	4250	0.14			
SDNT2012X154□4250◎TF	150	4250	0.11			
SDNT2012X224□4300◎TF	220	4300	0.08			

※□: Please specify the resistance tolerance code (F=±1%, H=±3%, J=±5%, K=±10%).

※◎: Please specify the B value tolerance code (F=±1%, H=±3%).

And products with other electrical characteristics can be provided upon customer's request. Please contact your local sales.

TYPICAL ELECTRICAL CHARACTERISTICS

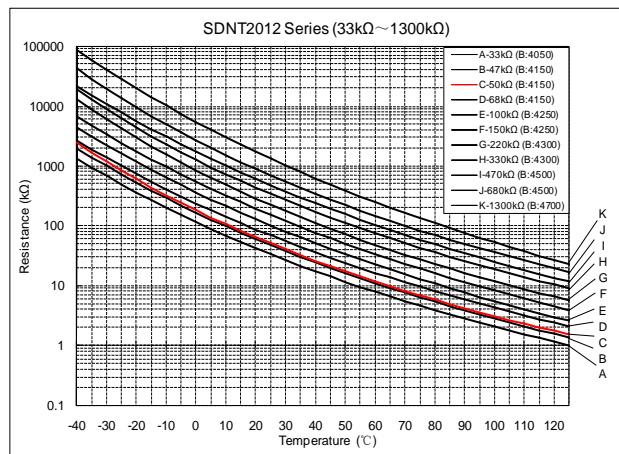
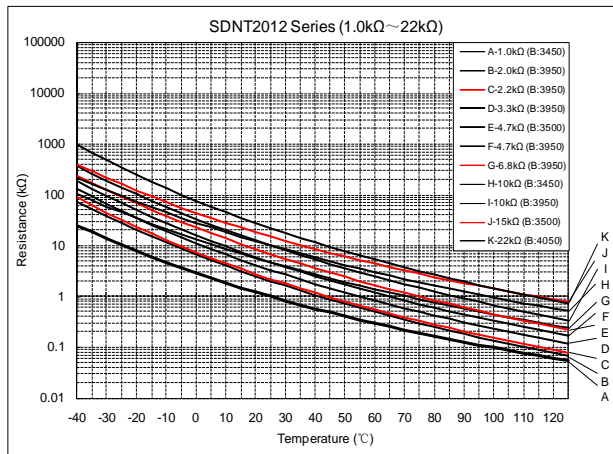
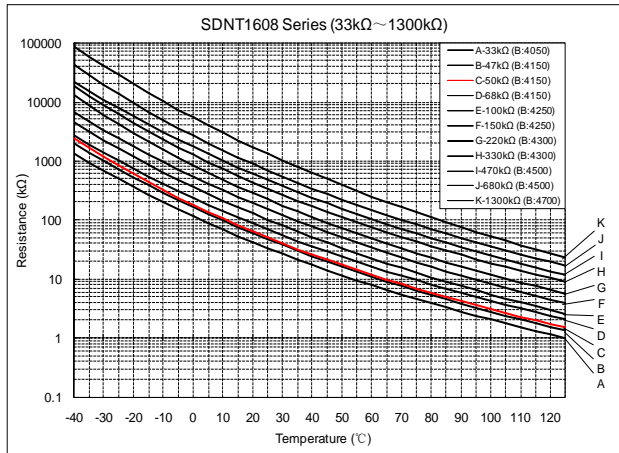
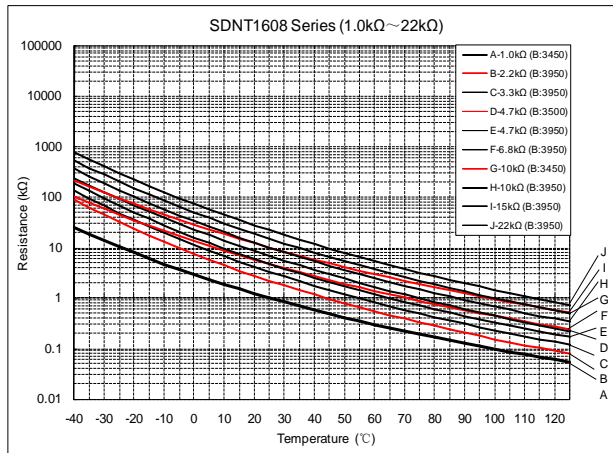
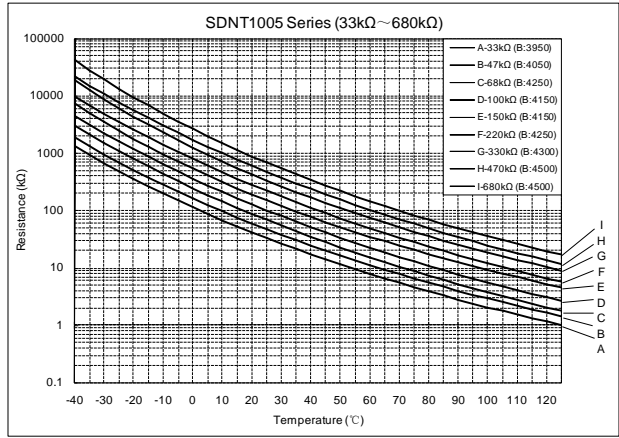
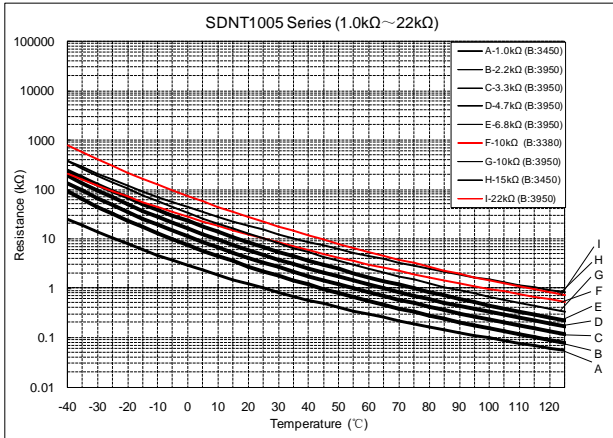
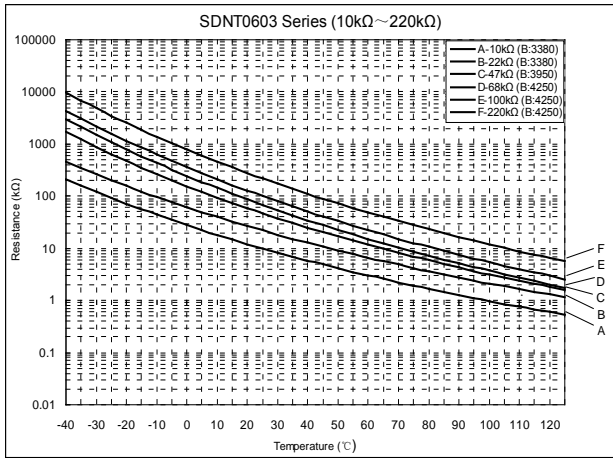

X-ON Electronics

Largest Supplier of Electrical and Electronic Components

Click to view similar products for [NTC \(Negative Temperature Coefficient\) Thermistors](#) category:

Click to view products by [Sunlord](#) manufacturer:

Other Similar products are found below :

[118-253FAJ-P01](#) [121-202EAC-P01](#) [123-802EAJ-P01](#) [128-105NDP-Q02](#) [135-503LAD-J01](#) [B57250V2104F360](#) [B57250V2473F560](#)
[B57620C472K962](#) [NTCLE410E3103F](#) [A1004SG22P0](#) [199-303KAF-A02](#) [30054-4](#) [M09N038F](#) [B57423V2473H062](#) [B57471V2474H062](#)
[B57620C5223J062](#) [500-52AA04-101](#) [526-31AA19-104](#) [526-31AN12-202](#) [103AT-5-1P-FT](#) [10K3A542I](#) [112-103FAG-H02](#) [112-104KAG-](#)
[B01](#) [11028414-00](#) [111-182CAG-H01](#) [112-103FAF-H01](#) [112-104KBF-F01](#) [118-202CAJ-P01](#) [526-31AA79-102](#) [B57442V5103J62](#)
[B57401V2103H62](#) [B57621C5472J62](#) [11032565-00](#) [194303KEVA01](#) [NTCACAPE3C90193](#) [USP11595](#) [B57359V2224J260](#)
[B57343V5103J360](#) [50070974-003-01](#) [189-602LDR-A01](#) [B57621C5472K062](#) [135-105QAF-J02](#) [B57421V2153J062](#) [B57230V2103H260](#)
[B57471V2684H062](#) [B57471V2333H062](#) [126-153YJC-B01](#) [NTCS0603E3333FHT](#) [118-802EAJ-P01](#) [121-103FAC-Q02](#)