

SPECIFICATIONS

Customer	
Product Name	Multi-layer Chip Varistor
Sunlord Part Number	SDV1005 Series
Customer Part Number	

New Released, Revised]

SPEC No.: **SDV170000**

Rev.	Effective Date	Changed Contents	Change Reasons	Approved By
01	/	New release	/	Hai Guo

【This SPEC is total 10 pages including specifications and appendix.】

【ROHS Compliant Parts】

Approved By	Checked By	Issued By

Shenzhen Sunlord Electronics Co., Ltd.

Address: Sunlord Industrial Park, Dafuyuan Industrial Zone, Baoan, Shenzhen, China 518110

Tel: 0086-755-29832660

Fax: 0086-755-82269029

E-Mail: sunlord@sunlordinc.com

【For Customer approval Only】

Date: _____

Qualification Status: Full Restricted Rejected

Approved By	Verified By	Re-checked By	Checked By

Comments:

Caution

All products listed in this specification are developed, designed and intended for use in general electronics equipment. The products are not designed or warranted to meet the requirements of the applications listed below, whose performance and/or quality require especially high reliability, or whose failure, malfunction or trouble might directly cause damage to society, person, or property. Please understand that we are not responsible for any damage or liability caused by use of the products in any of the applications below. Please contact us for more details if you intend to use our products in the following applications.

1. Aircraft equipment
2. Aerospace equipment
3. Undersea equipment
4. nuclear control equipment
5. military equipment
6. Power plant equipment
7. Medical equipment
8. Transportation equipment (automobiles, trains, ships, etc.)
9. Traffic signal equipment
10. Disaster prevention / crime prevention equipment
11. Data-processing equipment
12. Applications of similar complexity or with reliability requirements comparable to the applications listed in the above

1. Scope

This specification applies to SDV1005 Series of multi-layer chip varistors.

2. Product Description and Identification (Part Number)

- 1) Description
SDV1005 Series of multi-layer chip varistors.
- 2) Product Identification (Part Number)

SDV 1005 \odot xxx □□□□ ○ △ T S F
 ① ② ③ ④ ⑤ ⑥ ⑦ ⑧ ⑨ ⑩

① Type	
SDV	Chip Varistor

② External Dimensions (LxW) (mm)	
1005 [0402]	1.0x0.5

③ Feature Code	
A	For general use
E	For ESD
H	For high speed
S	For special request

④ Maximum Continuous Working Voltage	
Example	Nominal Value
5R5	5.5V
180	18V

⑤ Capacitance @1MHz	
Example	Nominal Value
C050	5pF
C500	50pF
C151	150pF

⑥ Tolerance of Capacitance	
N	±30%
Y	+100%/-50%
G	Maximum

⑧ Packing	
T	Tape & Reel

⑦ Terminal Code	
P	Ni, Sn plating

⑨ Products specifications	
S	Sb Free

⑩ HSF Products	
Hazardous Substance Free Products	

3. Electrical Characteristics

Please refer to Appendix A (Page 8-9).

- 1) Operating and storage temperature range (individual chip without packing): -55°C ~ +125°C.
- 2) Storage temperature range (packaging conditions): -10°C~+40°C RH 70% (Max.).

4. Shape and Dimensions

- 1) Dimensions and recommended PCB pattern for reflow soldering: See Fig.4-1, Fig.4-2 and Table 4-1.
- 2) Structure: See Fig. 4-3 and Fig. 4-4.

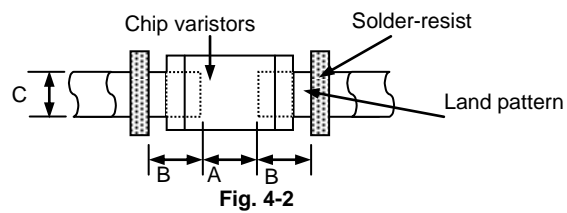
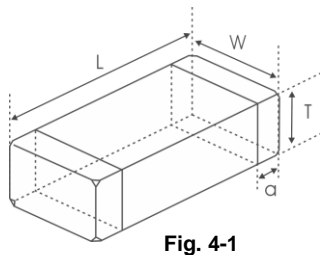

[Table 4-1]

Unit: mm [inch]

Type	L	W	T	a	A	B	C
1005 [0402]	1.0±0.15 [0.039±0.006]	0.5±0.15 [0.020±0.006]	0.5±0.15 [0.020±0.006]	0.25±0.1 [0.010±0.004]	0.45~0.55	0.40~0.50	0.45~0.55

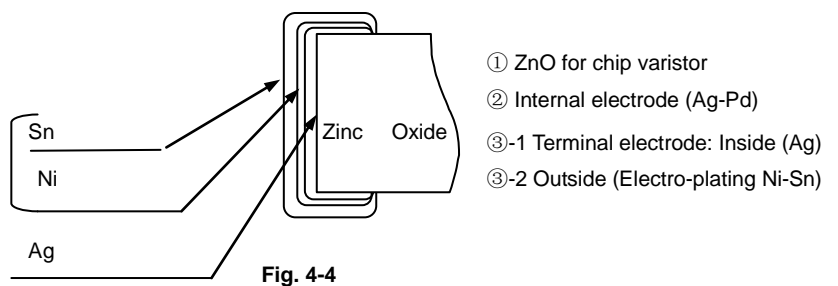
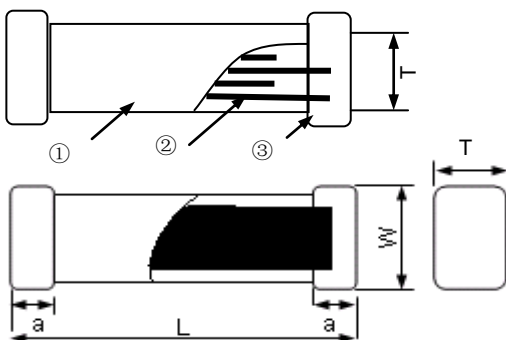

Fig. 4-3

Fig. 4-4

5. Test and Measurement Procedures

5.1 Test Conditions

5.1.1 Unless otherwise specified, the standard atmospheric conditions for measurement/test as:

- a. Ambient Temperature: 20±15°C.
- b. Relative Humidity: 65±20%.
- c. Air Pressure: 86kPa to 106kPa.

5.1.2 If any doubt on the results, measurements/tests should be made within the following limits:

- a. Ambient Temperature: 20±2°C
- b. Relative Humidity: 65±5%.
- c. Air Pressure: 86kPa to 106kPa.

5.2 Visual Examination

- a. Inspection Equipment: 20× magnifier.

5.3 Electrical Test

Items	Requirements	Test Methods and Remarks
5.3.1 Varistor Voltage at 1mA DC (V_B)	Refer to Appendix A	Measuring current: 1mA DC Duration: 0.2 to 2 sec
5.3.2 Capacitance (C)	Refer to Appendix A	Measure source: 0.5 V_{RMS} Test frequency: 1MHz.
5.3.3 Leakage Current (I_L)	Refer to Appendix A	Measuring voltage: Maximum DC working voltage
5.3.4 Clamping Voltage (V_C)	Refer to Appendix A	Measuring source: 8/20us waveform, ESD waveform

5.4 Reliability Test

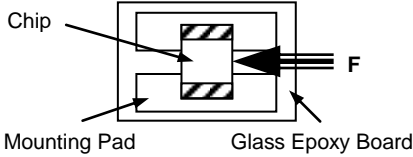
Items	Requirements	Test Methods and Remarks
5.4.1. Terminal Strength	<p>No removal or split of the termination or other defects shall occur.</p>  <p style="text-align: center;">Fig.5.4.1-1</p>	<ul style="list-style-type: none"> ① Solder the chip to the testing jig (glass epoxy board shown in Fig.5.4.1-1) using eutectic solder. Then apply a force in the direction of the arrow. ② 5N force for SDV1005 series, ③ Keep time: 10±1s.

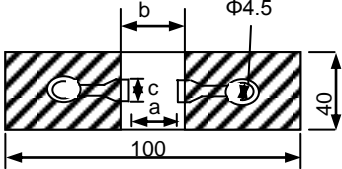
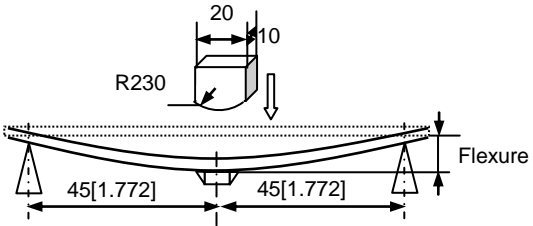
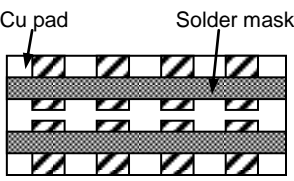
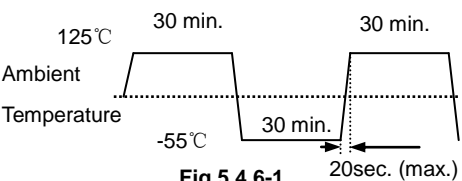
<p>5.4.2 Resistance to Flexure</p>	<p>No visible mechanical damage.</p> <table border="1" data-bbox="304 168 710 259"> <thead> <tr> <th>Type</th> <th>a</th> <th>b</th> <th>c</th> </tr> </thead> <tbody> <tr> <td>1005[0402]</td> <td>0.4</td> <td>1.5</td> <td>0.5</td> </tr> </tbody> </table> <p>Unit: mm [inch]</p>  <p>Fig. 5.4.2-1</p>	Type	a	b	c	1005[0402]	0.4	1.5	0.5	<ol style="list-style-type: none"> ① Solder the chip to the test jig (glass epoxy board shown in Fig. 5.4.2-1) using a eutectic solder. Then apply a force in the direction shown in Fig. 5.4.2-2. ② Flexure: 2mm. ③ Pressurizing Speed: 0.5mm/sec. ④ Keep time: 30 sec.  <p>Fig. 5.4.2-2</p>
Type	a	b	c							
1005[0402]	0.4	1.5	0.5							
<p>5.4.3 Vibration</p>	<p>No visible mechanical damage.</p>  <p>Glass Epoxy Board Fig. 5.4.3-1</p>	<ol style="list-style-type: none"> ① Solder the chip to the testing jig (glass epoxy board shown in Fig. 5.4.3-1) using eutectic solder. ② The chip shall be subjected to a simple harmonic motion having total amplitude of 1.5mm, the frequency being varied uniformly between the approximate limits of 10 and 55 Hz. ③ The frequency range from 10 to 55 Hz and return to 10 Hz shall be traversed in approximately 1 minute. This motion shall be applied for a period of 2 hours in each 3 mutually perpendicular directions (total of 6 hours). 								
<p>5.4.4 Solderability</p>	<ol style="list-style-type: none"> ① No visible mechanical damage. ② Wetting shall exceed 90% coverage. 	<ol style="list-style-type: none"> ① Solder temperature: 240±2℃ ② Duration: 3 sec. ③ Solder: Sn/3.0Ag/0.5Cu. ④ Flux: 25% Resin and 75% ethanol in weight. 								
<p>5.4.5 Resistance to Soldering Heat</p>	<ol style="list-style-type: none"> ① No visible mechanical damage. ② Varistor voltage change: within ±10%. 	<ol style="list-style-type: none"> ① Solder temperature: 260±3℃ ② Duration: 5 sec. ③ The chip shall be stabilized at normal condition for 1~2hours before measuring. ④ Solder: Sn/3.0Ag/0.5Cu. ⑤ Flux: 25% Resin and 75% ethanol in weight. 								
<p>5.4.6 Thermal Shock</p>	<ol style="list-style-type: none"> ① No visible mechanical damage. ② Varistor voltage change: within ±10%.  <p>Fig 5.4.6-1</p>	<ol style="list-style-type: none"> ① Temperature, Time: -55℃ for 30±3 min→125℃ for 30±3min. ② Transforming interval: 20sec. (max.) ③ Tested cycle: 100 cycles. ④ The chip shall be stabilized at normal condition for 1~2 hours before measuring. 								
<p>5.4.7 Resistance to Low Temperature</p>	<ol style="list-style-type: none"> ① No visible mechanical damage. ② Varistor voltage change: within ±10%. 	<ol style="list-style-type: none"> ① Temperature: -55±2℃ ② Duration: 1000⁺²⁴ hours. ③ The chip shall be stabilized at normal condition for 1~2 hours before measuring. 								
<p>5.4.8 Resistance to High Temperature</p>	<ol style="list-style-type: none"> ① No visible mechanical damage. ② Varistor voltage change: within ±10%. 	<ol style="list-style-type: none"> ① Temperature: 125±2℃. ② Duration: 1000⁺²⁴ hours. ③ The chip shall be stabilized at normal condition for 1~2 hours before measuring. 								
<p>5.4.9 Damp Heat (Steady States)</p>	<ol style="list-style-type: none"> ① No visible mechanical damage. ② Varistor voltage change: within ±10%. 	<ol style="list-style-type: none"> ① Temperature: 60±2℃ ② Humidity: 90% to 95% RH. ③ Duration: 1000⁺²⁴ hours. ④ The chip shall be stabilized at normal condition for 1~2 hours before measuring. 								

<p>5.4.10 Loading Under Damp Heat</p>	<p>① No visible mechanical damage. ② Varistor voltage change: within $\pm 10\%$.</p>	<p>① Temperature: $60 \pm 2^\circ\text{C}$ ② Humidity: 90% to 95% RH. ③ Duration: 1000^{+24} hours. ④ Applied voltage: DC Working Voltage. ⑤ The chip shall be stabilized at normal condition for 1~2 hours before positive and negative direction measuring.</p>
<p>5.4.11 Loading at High Temperature (Life Test)</p>	<p>① No visible mechanical damage. ② Varistor voltage change: within $\pm 10\%$.</p>	<p>① Temperature: $125 \pm 2^\circ\text{C}$ ② Duration: 1000^{+24} hours. ③ Applied voltage: DC Working Voltage. ④ The chip shall be stabilized at normal condition for 1~2 hours before positive and negative direction measuring.</p>
<p>5.4.12 Maximum Surge Current</p>	<p>① No visible mechanical damage. ② Varistor voltage change: within $\pm 10\%$. IEC61000-4-5 standard 1.2/50us-8/20us voltage-current combination pulse</p>	<p>① Temperature: $25 \pm 5^\circ\text{C}$ ② Humidity: 30% to 65% RH. ③ Number of hit: each 1 time of +/- polarity. ④ Pulse waveform: 8/20 us. ⑤ Applied current: maximum surge current (I_p). ⑥ The chip shall be stabilized at normal condition for 1~2 hours before positive and negative direction measuring.</p>
<p>5.4.13 Maximum Surge Energy</p>	<p>① No visible mechanical damage. ② Varistor voltage change: within $\pm 10\%$. IEC61000-4-5 standard 10/1000us current pulse</p>	<p>① Temperature: $25 \pm 5^\circ\text{C}$ ② Humidity: 30% to 65% RH. ③ Number of hit: 1 time. ④ Pulse waveform: 10/1000 us. ⑤ Applied energy: maximum surge energy (E_T). ⑥ The chip shall be stabilized at normal condition for 1~2 hours before positive and negative direction measuring.</p>
<p>5.4.14 ESD Life</p>	<p>① No visible mechanical damage. ② Varistor voltage change: within $\pm 10\%$. IEC61000-4-2 standard ESD gun C=150pF R=330Ω</p>	<p>① Discharge: Contact discharge. ② Voltage: 8000V (Level 4). ③ Polarity: +, -. ④ Number: 10 times within 10 sec. ⑤ The chip shall be stabilized at normal condition for 1~2 hours before positive and negative direction measuring.</p>
<p>5.4.15 ESD Test</p>	<p>① No visible mechanical damage. ② Varistor voltage change: within $\pm 10\%$. IEC61000-4-2 standard ESD gun C=150pF R=330Ω</p>	<p>① Discharge: Air discharge. ② Voltage: 15000V (Special level). ③ Polarity: +, - ④ Number: 10 times within 10 sec. ⑤ The chip shall be stabilized at normal condition for 1~2 hours before positive and negative direction measuring.</p>

6. Packaging and Storage

6.1 Packaging

6.1.1 Tape Carrier Packaging:

Packaging code: T

- a. Tape carrier packaging are specified in attached figure **Fig.6.1-1~3**
- b. Tape carrier packaging quantity please see the following table:

Type	1005[0402]
T(mm)	0.5 \pm 0.15
Tape	Paper Tape
Quantity	10K

(1) Taping Drawings (Unit: mm)

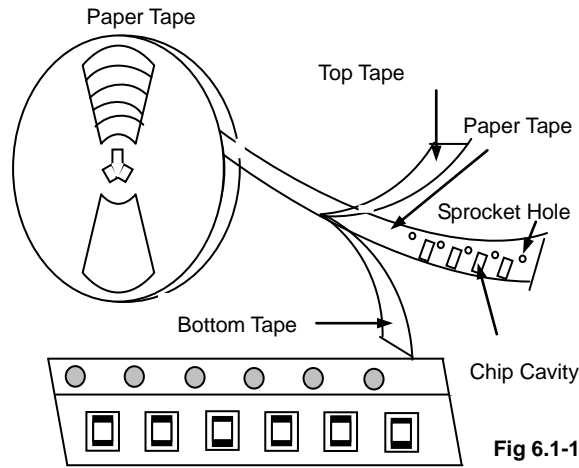

Remark: The sprocket holes are to the right as the tape is pulled toward the user.

(2) Taping Dimensions (Unit: mm)

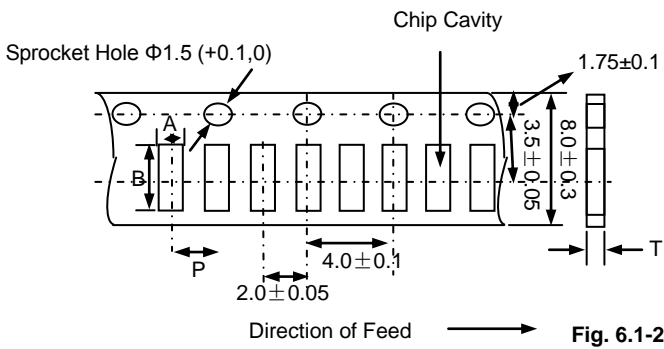

Type	A	B	P	T max
1005[0402]	0.65 ± 0.1	1.15 ± 0.1	2.0 ± 0.05	0.8

(3) Reel Dimensions (Unit: mm)

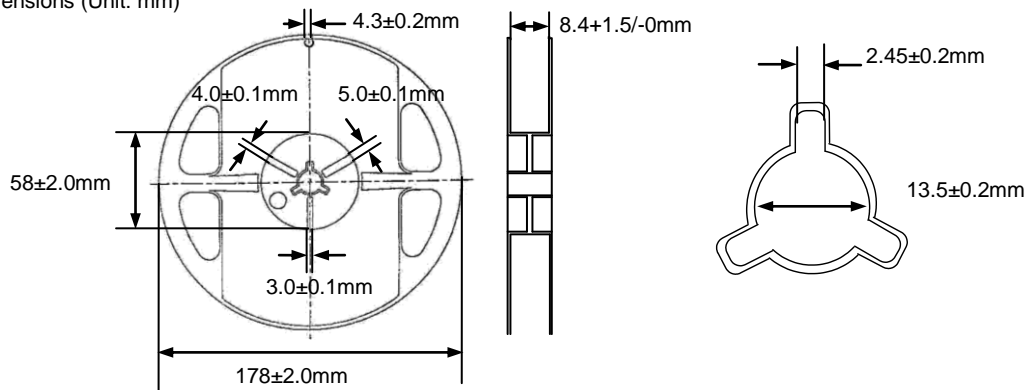

6.2 Storage

- a. The solderability of the external electrode may be deteriorated if packages are stored where they are exposed to high humidity. Package must be stored at 40°C or less and 70% RH or less.
- b. The solderability of the external electrode may be deteriorated if packages are stored where they are exposed to dust or harmful gas (e.g. HCl, sulfurous gas of H_2S).
- c. Packaging material may be deformed if package are stored where they are exposed to heat of direct sunlight.
- d. Solderability specified in **Clause 5.4.6** shall be guaranteed for 6 months from the date of delivery on condition that they are stored at the environment specified in **Clause 3**. For those parts, which passed more than 6 months shall be checked solder-ability before use.

7. Recommended Soldering Technologies

7.1 Re-flowing Profile:

- △ Preheat condition: $150 \sim 200^\circ\text{C} / 60 \sim 120$ sec.
- △ Allowed time above 217°C : $60 \sim 90$ sec.
- △ Max temp: 260°C
- △ Max time at max temp: 10sec.
- △ Solder paste: Sn/3.0Ag/0.5Cu
- △ Allowed Reflow time: 2x max.

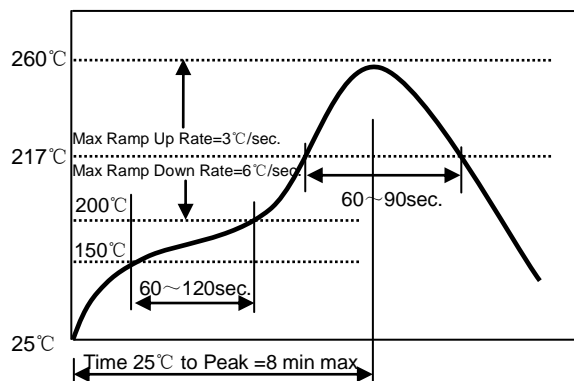

[Note: The reflow profile in the above table is only for qualification and is not meant to specify board assembly profiles. Actual board assembly profiles must be based on the customer's specific board design, solder paste and process, and should not exceed the parameters as the Reflow profile shows.]

7.2 Iron Soldering Profile.

- △ Iron soldering power: Max.30W
- △ Pre-heating: 150 °C / 60 sec.
- △ Soldering Tip temperature: 350°C Max.
- △ Soldering time: 3 sec Max.
- △ Solder paste: Sn/3.0Ag/0.5Cu
- △ Max.1 times for iron soldering

[Note: Take care not to apply the tip of the soldering iron to the terminal electrodes.]

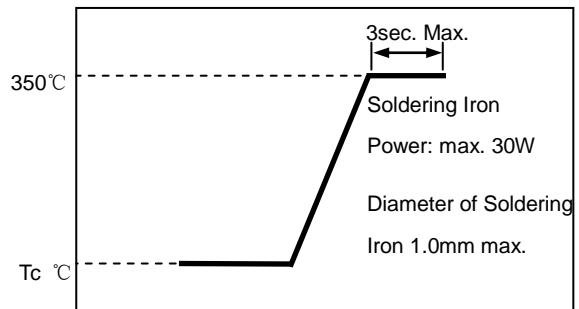

8. Supplier Information

- a) Supplier:
Shenzhen Sunlord Electronics Co., Ltd.
- b) Manufacturer:
Shenzhen Sunlord Electronics Co., Ltd.
- c) Manufacturing Address:
Sunlord Industrial Park, Dafuyuan Industrial Zone, Guanlan, Shenzhen, China
Zip: 518110

Appendix A: Electrical Characteristics (SDV Series of Varistors)

I. SDV1005A Series

Part Number	Max. Working Voltage		Varistor Voltage	Max. Clamping Voltage		Rated Single Pulse Transient		Typical Capacitance
	DC	AC RMS		8/20 μ s	ESD	Energy 10/1000 μ s	Peak Current 8/20 μ s	
Test Condition	<20 μ A		@1mA DC	8/20 μ s	ESD	Energy 10/1000 μ s	Peak Current 8/20 μ s	@0.5V _{rms} , 1MHz
Units	Volts	Volts	Volts	Volts	Volts	Joules	Amps	pF
Symbol	V _{WDC}	V _{WAC}	V _B	V _C ^{*1}	V _C ^{*2}	E _T	I _P	C
SDV1005A5R5C181□PTSF	5.5	4.0	10.0-14.0	18	23	0.05	20	180
SDV1005A5R5C231□PTSF	5.5	4.0	10.0-14.0	18	23	0.05	20	230
SDV1005A5R5C361□PTSF	5.5	4.0	10.0-14.0	18	23	0.05	20	360
SDV1005A090C121□PTSF	9.0	6.4	11.0-16.0	20	26	0.05	20	120
SDV1005A090C231□PTSF	9.0	6.4	11.0-16.0	20	26	0.05	20	230
SDV1005A140C121□PTSF	14.0	10.0	16.0-22.0	30	39	0.05	20	120

II. SDV1005E Series

Part Number	Max. Working Voltage		Varistor Voltage	Max. Clamping Voltage		Rated Single Pulse Transient		Typical Capacitance
	DC	AC RMS		8/20 μ s	ESD	Energy 10/1000 μ s	Peak Current 8/20 μ s	
Test Condition	<20 μ A		@1mA DC	8/20 μ s	ESD	Energy 10/1000 μ s	Peak Current 8/20 μ s	@0.5V _{rms} , 1MHz
Units	Volts	Volts	Volts	Volts	Volts	Joules	Amps	pF
Symbol	V _{WDC}	V _{WAC}	V _B	V _C ^{*1}	V _C ^{*2}	E _T	I _P	C
SDV1005E5R5C180□PTSF	5.5	4.0	10.0-14.0	18	23	0.005	3	18
SDV1005E5R5C300□PTSF	5.5	4.0	10.0-14.0	18	23	0.005	5	30
SDV1005E5R5C500□PTSF	5.5	4.0	10.0-14.0	18	23	0.01	10	50
SDV1005E5R5C800□PTSF	5.5	4.0	10.0-14.0	18	23	0.02	10	80
SDV1005E5R5C101□PTSF	5.5	4.0	10.0-14.0	18	23	0.05	20	100
SDV1005E090C180□PTSF	9.0	6.4	11.0-16.0	20	26	0.005	3	18
SDV1005E090C300□PTSF	9.0	6.4	11.0-16.0	20	26	0.005	5	30
SDV1005E090C500□PTSF	9.0	6.4	11.0-16.0	20	26	0.01	10	50
SDV1005E090C800□PTSF	9.0	6.4	11.0-16.0	20	26	0.02	15	80
SDV1005E090C101□PTSF	9.0	6.4	11.0-16.0	20	26	0.05	20	100
SDV1005E140C180□PTSF	14.0	10.0	16.0-22.0	30	39	0.005	3	18
SDV1005E140C300□PTSF	14.0	10.0	16.0-22.0	30	39	0.01	5	30
SDV1005E140C500□PTSF	14.0	10.0	16.0-22.0	30	39	0.02	10	50
SDV1005E140C800□PTSF	14.0	10.0	16.0-22.0	30	39	0.03	15	80
SDV1005E140C101□PTSF	14.0	10.0	16.0-22.0	30	39	0.05	20	100
SDV1005E180C150□PTSF	18.0	12.7	22.0-28.0	40	48	0.005	2	15
SDV1005E180C180□PTSF	18.0	12.7	22.0-28.0	40	48	0.01	5	18
SDV1005E180C300□PTSF	18.0	12.7	22.0-28.0	40	48	0.02	10	30
SDV1005E180C500□PTSF	18.0	12.7	22.0-28.0	40	48	0.02	10	50
SDV1005E180C800□PTSF	18.0	12.7	22.0-28.0	40	48	0.03	15	80
SDV1005E260C180□PTSF	26.0	18.4	31.0-38.0	58	70	0.02	5	18
SDV1005E260C300□PTSF	26.0	18.4	31.0-38.0	58	70	0.03	10	30
SDV1005E260C500□PTSF	26.0	18.4	31.0-38.0	58	70	0.03	10	50

III . SDV1005H Series

Part Number	Max. Working Voltage		Varistor Voltage	Max. Clamping Voltage		Rated Single Pulse Transient		Typical Capacitance
	DC	AC RMS		8/20 μ s	ESD	Energy 10/1000 μ s	Peak Current 8/20 μ s	
Test Condition	<20 μ A		@1mA DC	8/20 μ s	ESD	Energy 10/1000 μ s	Peak Current 8/20 μ s	@0.5V _{rms} , 1MHz
Units	Volts	Volts	Volts	Volts	Volts	Joules	Amps	pF
Symbol	V _{WDC}	V _{WAC}	V _B	V _C ^{*1}	V _C ^{*2}	E _T	I _P	C
SDV1005H140C100□PTSF	14.0	10.0	16.0-22.0	30	39	0.005	2	10
SDV1005H140C120□PTSF	14.0	10.0	16.0-22.0	30	39	0.005	2	12
SDV1005H180C050□PTSF	18.0	12.7	22.0-28.0	40	48	0.005	2	5
SDV1005H180C100□PTSF	18.0	12.7	22.0-28.0	40	48	0.005	2	10
SDV1005H260C030□PTSF	26.0	18.4	31.0-38.0	58	70	0.003	1	3
SDV1005H260C100□PTSF	26.0	18.4	31.0-38.0	58	70	0.005	2	10

※*1: V_c, Maximum peak voltage across the varistor measured at a specified pulse current and waveform.

Energy Rating Pulse & Waveform

0.00-0.05 Joule 1A, 8/20 μ s

0.10 Joule 2A, 8/20 μ s

0.20-0.50 Joule 5A, 8/20 μ s

※*2: V_c, Maximum peak voltage across the varistor measured at 30ns after initiation of pulse on IEC61000-4-2 30A/8KV.

※□: Please specify the capacitance tolerance code (N=±30%, Y=+100%~-50%, G=Maximum).

X-ON Electronics

Largest Supplier of Electrical and Electronic Components

Click to view similar products for [Varistors](#) category:

Click to view products by [Sunlord](#) manufacturer:

Other Similar products are found below :

[820443211E](#) [MOV05131AIA](#) [MOV07231AQA](#) [MOV18131CZA](#) [R71ZOV151HC](#) [D58ZOV500RA01T1](#) [B72205S271K111](#)
[B72214S110K151](#) [B72214S251K151](#) [B72232B131K1](#) [B72280B271K1](#) [B72530E1140S272](#) [B72540E250K62](#) [B72650M0151K093](#)
[B72660M0271K093](#) [NTE1V020](#) [NTE1V130](#) [NTE2V010](#) [NTE2V130](#) [238159352716](#) [25FN511K](#) [S10K11G5S5](#) [ERZ-C14DK361U](#) [ERZ-](#)
[C20DK221U](#) [ERZ-C32CK201B](#) [207869-1](#) [AS-13](#) [TMOV25SP625E](#) [TND10V-471KB00AAA0](#) [B72210S251K531](#) [B72214S200K551](#)
[B72280B112K1](#) [B72280B381K1](#) [B72590D360A60](#) [B72650M301K93](#) [B72670M1140K72](#) [MOV07251ARA](#) [MOV10131EDA](#)
[MOV10151EFA](#) [MOV14151CWA](#) [MOV20251DFA](#) [TVZ18EC271KBS](#) [TVZ20EB911KBS](#) [TVZ25D201KBS](#) [TVZ25D241KBS](#)
[VDRH20X230BSE](#) [VZ07D220KBS](#) [VZ40D241K](#) [VZ25D511KBS-N](#) [VZ20E511KBSX](#)