

# Wire Wound Chip Ceramic Inductor – SDWL-C Series

Operating Temp. : -40°C~+125°C



## FEATURES

- Small chip suitable for surface mounting
- High Q value and high self-resonant frequency with ceramic material
- Tight inductance tolerance and stable inductance at high frequency

## APPLICATIONS

- High frequency circuit in telecommunication and other equipments
- Mobile phones such as GSM, CDMA, PDC, etc.
- Bluetooth, W-LAN, Broadband network

## PRODUCT IDENTIFICATION

| <u>SDWL</u><br>①  | <u>1005</u><br>②                 | <u>C</u><br>③ | <u>10N</u><br>④ | <u>J</u><br>⑤            | <u>S</u><br>⑥  | <u>T</u><br>⑦       | <u>F</u><br>⑧ |      |        |      |        |      |        |      |        |      |        |      |        |      |        |  |               |  |   |         |   |                    |  |         |               |     |      |     |       |     |       |   |                      |  |   |        |   |        |   |        |   |        |   |     |   |     |   |     |   |      |  |              |  |   |                                  |   |                                  |  |         |  |   |             |   |                                   |  |   |  |
|---|----------------------------------|---------------|-----------------|--------------------------|--|---------------------|---------------|------|--------|------|--------|------|--------|------|--------|------|--------|------|--------|------|--------|--|---------------|--|---|---------|---|--------------------|--|---------|---------------|-----|------|-----|-------|-----|-------|---|----------------------|--|---|--------|---|--------|---|--------|---|--------|---|-----|---|-----|---|-----|---|------|--|--------------|--|---|----------------------------------|---|----------------------------------|--|---------|--|---|-------------|---|-----------------------------------|--|---|--|
| ①   | ②                                | ③             | ④               | ⑤                        | ⑥  | ⑦                   | ⑧             |      |        |      |        |      |        |      |        |      |        |      |        |      |        |  |               |  |   |         |   |                    |  |         |               |     |      |     |       |     |       |   |                      |  |   |        |   |        |   |        |   |        |   |     |   |     |   |     |   |      |  |              |  |   |                                  |   |                                  |  |         |  |   |             |   |                                   |  |   |  |
| <table border="1"> <thead> <tr> <th colspan="2">Type</th> </tr> </thead> <tbody> <tr> <td>SDWL</td> <td>Wire Wound Chip Inductor</td> </tr> </tbody> </table> | Type                             |               | SDWL            | Wire Wound Chip Inductor | <table border="1"> <thead> <tr> <th colspan="2">External Dimensions</th> </tr> </thead> <tbody> <tr> <td>1005</td> <td>[0402]</td> </tr> <tr> <td>1608</td> <td>[0603]</td> </tr> <tr> <td>2012</td> <td>[0805]</td> </tr> <tr> <td>2520</td> <td>[1008]</td> </tr> <tr> <td>3216</td> <td>[1206]</td> </tr> <tr> <td>3225</td> <td>[1210]</td> </tr> <tr> <td>4532</td> <td>[1812]</td> </tr> </tbody> </table> | External Dimensions |               | 1005 | [0402] | 1608 | [0603] | 2012 | [0805] | 2520 | [1008] | 3216 | [1206] | 3225 | [1210] | 4532 | [1812] | <table border="1"> <thead> <tr> <th colspan="2">Material Code</th> </tr> </thead> <tbody> <tr> <td>C</td> <td>Ceramic</td> </tr> </tbody> </table> | Material Code |  | C | Ceramic | <table border="1"> <thead> <tr> <th colspan="2">Nominal Inductance</th> </tr> </thead> <tbody> <tr> <th>Example</th> <th>Nominal Value</th> </tr> <tr> <td>10N</td> <td>10nH</td> </tr> <tr> <td>R10</td> <td>100nH</td> </tr> <tr> <td>1R0</td> <td>1.0μH</td> </tr> </tbody> </table> | Nominal Inductance |  | Example | Nominal Value | 10N | 10nH | R10 | 100nH | 1R0 | 1.0μH | <table border="1"> <thead> <tr> <th colspan="2">Inductance Tolerance</th> </tr> </thead> <tbody> <tr> <td>B</td> <td>±0.1nH</td> </tr> <tr> <td>C</td> <td>±0.2nH</td> </tr> <tr> <td>S</td> <td>±0.3nH</td> </tr> <tr> <td>D</td> <td>±0.5nH</td> </tr> <tr> <td>G</td> <td>±2%</td> </tr> <tr> <td>H</td> <td>±3%</td> </tr> <tr> <td>J</td> <td>±5%</td> </tr> <tr> <td>K</td> <td>±10%</td> </tr> </tbody> </table> | Inductance Tolerance |  | B | ±0.1nH | C | ±0.2nH | S | ±0.3nH | D | ±0.5nH | G | ±2% | H | ±3% | J | ±5% | K | ±10% | <table border="1"> <thead> <tr> <th colspan="2">Feature Type</th> </tr> </thead> <tbody> <tr> <td>S</td> <td>Sn Plating<br/>Five-faces Coating</td> </tr> <tr> <td>G</td> <td>Au Plating<br/>Five-faces Coating</td> </tr> </tbody> </table> | Feature Type |  | S | Sn Plating<br>Five-faces Coating | G | Au Plating<br>Five-faces Coating | <table border="1"> <thead> <tr> <th colspan="2">Packing</th> </tr> </thead> <tbody> <tr> <td>T</td> <td>Tape &amp; Reel</td> </tr> </tbody> </table> | Packing |  | T | Tape & Reel | <table border="1"> <thead> <tr> <th colspan="2">Hazardous Substance Free Products</th> </tr> </thead> <tbody> <tr> <td colspan="2">F</td> </tr> </tbody> </table> | Hazardous Substance Free Products |  | F |  |
| Type  |                                  |               |                 |                          |  |                     |               |      |        |      |        |      |        |      |        |      |        |      |        |      |        |  |               |  |   |         |   |                    |  |         |               |     |      |     |       |     |       |   |                      |  |   |        |   |        |   |        |   |        |   |     |   |     |   |     |   |      |  |              |  |   |                                  |   |                                  |  |         |  |   |             |   |                                   |  |   |  |
| SDWL  | Wire Wound Chip Inductor         |               |                 |                          |  |                     |               |      |        |      |        |      |        |      |        |      |        |      |        |      |        |  |               |  |   |         |   |                    |  |         |               |     |      |     |       |     |       |   |                      |  |   |        |   |        |   |        |   |        |   |     |   |     |   |     |   |      |  |              |  |   |                                  |   |                                  |  |         |  |   |             |   |                                   |  |   |  |
| External Dimensions   |                                  |               |                 |                          |  |                     |               |      |        |      |        |      |        |      |        |      |        |      |        |      |        |  |               |  |   |         |   |                    |  |         |               |     |      |     |       |     |       |   |                      |  |   |        |   |        |   |        |   |        |   |     |   |     |   |     |   |      |  |              |  |   |                                  |   |                                  |  |         |  |   |             |   |                                   |  |   |  |
| 1005  | [0402]                           |               |                 |                          |  |                     |               |      |        |      |        |      |        |      |        |      |        |      |        |      |        |  |               |  |   |         |   |                    |  |         |               |     |      |     |       |     |       |   |                      |  |   |        |   |        |   |        |   |        |   |     |   |     |   |     |   |      |  |              |  |   |                                  |   |                                  |  |         |  |   |             |   |                                   |  |   |  |
| 1608  | [0603]                           |               |                 |                          |  |                     |               |      |        |      |        |      |        |      |        |      |        |      |        |      |        |  |               |  |   |         |   |                    |  |         |               |     |      |     |       |     |       |   |                      |  |   |        |   |        |   |        |   |        |   |     |   |     |   |     |   |      |  |              |  |   |                                  |   |                                  |  |         |  |   |             |   |                                   |  |   |  |
| 2012  | [0805]                           |               |                 |                          |  |                     |               |      |        |      |        |      |        |      |        |      |        |      |        |      |        |  |               |  |   |         |   |                    |  |         |               |     |      |     |       |     |       |   |                      |  |   |        |   |        |   |        |   |        |   |     |   |     |   |     |   |      |  |              |  |   |                                  |   |                                  |  |         |  |   |             |   |                                   |  |   |  |
| 2520  | [1008]                           |               |                 |                          |  |                     |               |      |        |      |        |      |        |      |        |      |        |      |        |      |        |  |               |  |   |         |   |                    |  |         |               |     |      |     |       |     |       |   |                      |  |   |        |   |        |   |        |   |        |   |     |   |     |   |     |   |      |  |              |  |   |                                  |   |                                  |  |         |  |   |             |   |                                   |  |   |  |
| 3216  | [1206]                           |               |                 |                          |  |                     |               |      |        |      |        |      |        |      |        |      |        |      |        |      |        |  |               |  |   |         |   |                    |  |         |               |     |      |     |       |     |       |   |                      |  |   |        |   |        |   |        |   |        |   |     |   |     |   |     |   |      |  |              |  |   |                                  |   |                                  |  |         |  |   |             |   |                                   |  |   |  |
| 3225  | [1210]                           |               |                 |                          |  |                     |               |      |        |      |        |      |        |      |        |      |        |      |        |      |        |  |               |  |   |         |   |                    |  |         |               |     |      |     |       |     |       |   |                      |  |   |        |   |        |   |        |   |        |   |     |   |     |   |     |   |      |  |              |  |   |                                  |   |                                  |  |         |  |   |             |   |                                   |  |   |  |
| 4532  | [1812]                           |               |                 |                          |  |                     |               |      |        |      |        |      |        |      |        |      |        |      |        |      |        |  |               |  |   |         |   |                    |  |         |               |     |      |     |       |     |       |   |                      |  |   |        |   |        |   |        |   |        |   |     |   |     |   |     |   |      |  |              |  |   |                                  |   |                                  |  |         |  |   |             |   |                                   |  |   |  |
| Material Code   |                                  |               |                 |                          |  |                     |               |      |        |      |        |      |        |      |        |      |        |      |        |      |        |  |               |  |   |         |   |                    |  |         |               |     |      |     |       |     |       |   |                      |  |   |        |   |        |   |        |   |        |   |     |   |     |   |     |   |      |  |              |  |   |                                  |   |                                  |  |         |  |   |             |   |                                   |  |   |  |
| C   | Ceramic                          |               |                 |                          |  |                     |               |      |        |      |        |      |        |      |        |      |        |      |        |      |        |  |               |  |   |         |   |                    |  |         |               |     |      |     |       |     |       |   |                      |  |   |        |   |        |   |        |   |        |   |     |   |     |   |     |   |      |  |              |  |   |                                  |   |                                  |  |         |  |   |             |   |                                   |  |   |  |
| Nominal Inductance  |                                  |               |                 |                          |  |                     |               |      |        |      |        |      |        |      |        |      |        |      |        |      |        |  |               |  |   |         |   |                    |  |         |               |     |      |     |       |     |       |   |                      |  |   |        |   |        |   |        |   |        |   |     |   |     |   |     |   |      |  |              |  |   |                                  |   |                                  |  |         |  |   |             |   |                                   |  |   |  |
| Example   | Nominal Value                    |               |                 |                          |  |                     |               |      |        |      |        |      |        |      |        |      |        |      |        |      |        |  |               |  |   |         |   |                    |  |         |               |     |      |     |       |     |       |   |                      |  |   |        |   |        |   |        |   |        |   |     |   |     |   |     |   |      |  |              |  |   |                                  |   |                                  |  |         |  |   |             |   |                                   |  |   |  |
| 10N   | 10nH                             |               |                 |                          |  |                     |               |      |        |      |        |      |        |      |        |      |        |      |        |      |        |  |               |  |   |         |   |                    |  |         |               |     |      |     |       |     |       |   |                      |  |   |        |   |        |   |        |   |        |   |     |   |     |   |     |   |      |  |              |  |   |                                  |   |                                  |  |         |  |   |             |   |                                   |  |   |  |
| R10   | 100nH                            |               |                 |                          |  |                     |               |      |        |      |        |      |        |      |        |      |        |      |        |      |        |  |               |  |   |         |   |                    |  |         |               |     |      |     |       |     |       |   |                      |  |   |        |   |        |   |        |   |        |   |     |   |     |   |     |   |      |  |              |  |   |                                  |   |                                  |  |         |  |   |             |   |                                   |  |   |  |
| 1R0   | 1.0μH                            |               |                 |                          |  |                     |               |      |        |      |        |      |        |      |        |      |        |      |        |      |        |  |               |  |   |         |   |                    |  |         |               |     |      |     |       |     |       |   |                      |  |   |        |   |        |   |        |   |        |   |     |   |     |   |     |   |      |  |              |  |   |                                  |   |                                  |  |         |  |   |             |   |                                   |  |   |  |
| Inductance Tolerance  |                                  |               |                 |                          |  |                     |               |      |        |      |        |      |        |      |        |      |        |      |        |      |        |  |               |  |   |         |   |                    |  |         |               |     |      |     |       |     |       |   |                      |  |   |        |   |        |   |        |   |        |   |     |   |     |   |     |   |      |  |              |  |   |                                  |   |                                  |  |         |  |   |             |   |                                   |  |   |  |
| B   | ±0.1nH                           |               |                 |                          |  |                     |               |      |        |      |        |      |        |      |        |      |        |      |        |      |        |  |               |  |   |         |   |                    |  |         |               |     |      |     |       |     |       |   |                      |  |   |        |   |        |   |        |   |        |   |     |   |     |   |     |   |      |  |              |  |   |                                  |   |                                  |  |         |  |   |             |   |                                   |  |   |  |
| C   | ±0.2nH                           |               |                 |                          |  |                     |               |      |        |      |        |      |        |      |        |      |        |      |        |      |        |  |               |  |   |         |   |                    |  |         |               |     |      |     |       |     |       |   |                      |  |   |        |   |        |   |        |   |        |   |     |   |     |   |     |   |      |  |              |  |   |                                  |   |                                  |  |         |  |   |             |   |                                   |  |   |  |
| S   | ±0.3nH                           |               |                 |                          |  |                     |               |      |        |      |        |      |        |      |        |      |        |      |        |      |        |  |               |  |   |         |   |                    |  |         |               |     |      |     |       |     |       |   |                      |  |   |        |   |        |   |        |   |        |   |     |   |     |   |     |   |      |  |              |  |   |                                  |   |                                  |  |         |  |   |             |   |                                   |  |   |  |
| D   | ±0.5nH                           |               |                 |                          |  |                     |               |      |        |      |        |      |        |      |        |      |        |      |        |      |        |  |               |  |   |         |   |                    |  |         |               |     |      |     |       |     |       |   |                      |  |   |        |   |        |   |        |   |        |   |     |   |     |   |     |   |      |  |              |  |   |                                  |   |                                  |  |         |  |   |             |   |                                   |  |   |  |
| G   | ±2%                              |               |                 |                          |  |                     |               |      |        |      |        |      |        |      |        |      |        |      |        |      |        |  |               |  |   |         |   |                    |  |         |               |     |      |     |       |     |       |   |                      |  |   |        |   |        |   |        |   |        |   |     |   |     |   |     |   |      |  |              |  |   |                                  |   |                                  |  |         |  |   |             |   |                                   |  |   |  |
| H   | ±3%                              |               |                 |                          |  |                     |               |      |        |      |        |      |        |      |        |      |        |      |        |      |        |  |               |  |   |         |   |                    |  |         |               |     |      |     |       |     |       |   |                      |  |   |        |   |        |   |        |   |        |   |     |   |     |   |     |   |      |  |              |  |   |                                  |   |                                  |  |         |  |   |             |   |                                   |  |   |  |
| J   | ±5%                              |               |                 |                          |  |                     |               |      |        |      |        |      |        |      |        |      |        |      |        |      |        |  |               |  |   |         |   |                    |  |         |               |     |      |     |       |     |       |   |                      |  |   |        |   |        |   |        |   |        |   |     |   |     |   |     |   |      |  |              |  |   |                                  |   |                                  |  |         |  |   |             |   |                                   |  |   |  |
| K   | ±10%                             |               |                 |                          |  |                     |               |      |        |      |        |      |        |      |        |      |        |      |        |      |        |  |               |  |   |         |   |                    |  |         |               |     |      |     |       |     |       |   |                      |  |   |        |   |        |   |        |   |        |   |     |   |     |   |     |   |      |  |              |  |   |                                  |   |                                  |  |         |  |   |             |   |                                   |  |   |  |
| Feature Type  |                                  |               |                 |                          |  |                     |               |      |        |      |        |      |        |      |        |      |        |      |        |      |        |  |               |  |   |         |   |                    |  |         |               |     |      |     |       |     |       |   |                      |  |   |        |   |        |   |        |   |        |   |     |   |     |   |     |   |      |  |              |  |   |                                  |   |                                  |  |         |  |   |             |   |                                   |  |   |  |
| S   | Sn Plating<br>Five-faces Coating |               |                 |                          |  |                     |               |      |        |      |        |      |        |      |        |      |        |      |        |      |        |  |               |  |   |         |   |                    |  |         |               |     |      |     |       |     |       |   |                      |  |   |        |   |        |   |        |   |        |   |     |   |     |   |     |   |      |  |              |  |   |                                  |   |                                  |  |         |  |   |             |   |                                   |  |   |  |
| G   | Au Plating<br>Five-faces Coating |               |                 |                          |  |                     |               |      |        |      |        |      |        |      |        |      |        |      |        |      |        |  |               |  |   |         |   |                    |  |         |               |     |      |     |       |     |       |   |                      |  |   |        |   |        |   |        |   |        |   |     |   |     |   |     |   |      |  |              |  |   |                                  |   |                                  |  |         |  |   |             |   |                                   |  |   |  |
| Packing   |                                  |               |                 |                          |  |                     |               |      |        |      |        |      |        |      |        |      |        |      |        |      |        |  |               |  |   |         |   |                    |  |         |               |     |      |     |       |     |       |   |                      |  |   |        |   |        |   |        |   |        |   |     |   |     |   |     |   |      |  |              |  |   |                                  |   |                                  |  |         |  |   |             |   |                                   |  |   |  |
| T   | Tape & Reel                      |               |                 |                          |  |                     |               |      |        |      |        |      |        |      |        |      |        |      |        |      |        |  |               |  |   |         |   |                    |  |         |               |     |      |     |       |     |       |   |                      |  |   |        |   |        |   |        |   |        |   |     |   |     |   |     |   |      |  |              |  |   |                                  |   |                                  |  |         |  |   |             |   |                                   |  |   |  |
| Hazardous Substance Free Products   |                                  |               |                 |                          |  |                     |               |      |        |      |        |      |        |      |        |      |        |      |        |      |        |  |               |  |   |         |   |                    |  |         |               |     |      |     |       |     |       |   |                      |  |   |        |   |        |   |        |   |        |   |     |   |     |   |     |   |      |  |              |  |   |                                  |   |                                  |  |         |  |   |             |   |                                   |  |   |  |
| F   |                                  |               |                 |                          |  |                     |               |      |        |      |        |      |        |      |        |      |        |      |        |      |        |  |               |  |   |         |   |                    |  |         |               |     |      |     |       |     |       |   |                      |  |   |        |   |        |   |        |   |        |   |     |   |     |   |     |   |      |  |              |  |   |                                  |   |                                  |  |         |  |   |             |   |                                   |  |   |  |

## SHAPE AND DIMENSIONS

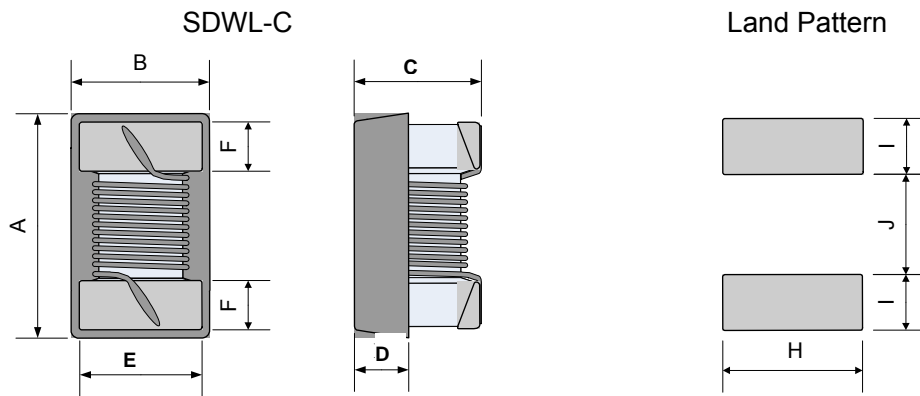

Unit: mm

| Series    | A Max. | B Max. | C Max. | D Typ. | E Typ. | F Typ. | H Typ. | I Typ. | J Typ. |
|-----------|--------|--------|--------|--------|--------|--------|--------|--------|--------|
| SDWL1005C | 1.19   | 0.64   | 0.66   | 0.20   | 0.50   | 0.20   | 0.65   | 0.35   | 0.50   |
| SDWL1608C | 1.80   | 1.12   | 1.02   | 0.38   | 0.76   | 0.33   | 1.02   | 0.64   | 0.64   |
| SDWL2012C | 2.29   | 1.73   | 1.55   | 0.51   | 1.27   | 0.50   | 1.78   | 1.02   | 0.76   |
| SDWL2520C | 2.92   | 2.79   | 2.29   | 0.51   | 2.10   | 0.50   | 2.54   | 1.02   | 1.27   |
| SDWL3216C | 3.56   | 2.16   | 1.52   | 0.51   | 1.60   | 0.50   | 1.93   | 1.02   | 1.78   |
| SDWL3225C | 3.65   | 2.95   | 2.70   | 0.51   | 2.10   | 0.50   | 3.02   | 1.02   | 1.78   |
| SDWL4532C | 4.95   | 3.81   | 3.43   | 1.78   | 2.90   | 0.58   | 3.05   | 1.14   | 3.00   |

## SPECIFICATIONS

### SDWL1005C-S TYPE

| Part Number      | Inductance | Tolerance   | Min. Quality Factor | L/Q Test Freq. | Max. DC Resistance | Max. Rated Current | Min. Self-resonant Frequency |
|------------------|------------|-------------|---------------------|----------------|--------------------|--------------------|------------------------------|
| Units            | nH         | -           | -                   | MHz            | $\Omega$           | mA                 | MHz                          |
| Symbol           | L          | -           | Q                   | Freq.          | DCR                | I <sub>r</sub>     | S.R.F                        |
| SDWL1005C0N8□STF | 0.8        | B,C,S,D,K   | 14                  | 250            | 0.035              | 1000               | >6000                        |
| SDWL1005C1N0□STF | 1.0        | B,C,S,D,K   | 10                  | 250            | 0.085              | 650                | >6000                        |
| SDWL1005C1N8□STF | 1.8        | B,C,S,D,J,K | 20                  | 250            | 0.043              | 950                | >6000                        |
| SDWL1005C1N9□STF | 1.9        | B,C,S,D,J,K | 20                  | 250            | 0.043              | 950                | >6000                        |
| SDWL1005C2N0□STF | 2.0        | B,C,S,D,J,K | 23                  | 250            | 0.043              | 950                | >6000                        |
| SDWL1005C2N2□STF | 2.2        | B,C,S,D,J,K | 22                  | 250            | 0.058              | 820                | >6000                        |
| SDWL1005C2N4□STF | 2.4        | B,C,S,D,J,K | 18                  | 250            | 0.091              | 650                | >6000                        |
| SDWL1005C3N0□STF | 3.0        | S,D,K       | 24                  | 250            | 0.063              | 790                | >6000                        |
| SDWL1005C3N3□STF | 3.3        | B,C,S,D,J,K | 24                  | 250            | 0.063              | 790                | >6000                        |
| SDWL1005C3N6□STF | 3.6        | B,C,S,D,J,K | 24                  | 250            | 0.063              | 790                | >6000                        |
| SDWL1005C3N9□STF | 3.9        | B,C,S,D,J,K | 24                  | 250            | 0.063              | 790                | >6000                        |
| SDWL1005C4N1□STF | 4.1        | B,C,S,D,J,K | 22                  | 250            | 0.070              | 700                | >6000                        |
| SDWL1005C4N3□STF | 4.3        | B,C,S,D,J,K | 22                  | 250            | 0.070              | 750                | >6000                        |
| SDWL1005C4N7□STF | 4.7        | B,C,S,D,J,K | 20                  | 250            | 0.120              | 570                | >6000                        |
| SDWL1005C5N1□STF | 5.1        | B,C,S,D,J,K | 23                  | 250            | 0.100              | 620                | >6000                        |
| SDWL1005C5N6□STF | 5.6        | B,C,S,D,J,K | 25                  | 250            | 0.078              | 710                | >6000                        |
| SDWL1005C5N8□STF | 5.8        | B,C,S,D,J,K | 25                  | 250            | 0.078              | 710                | >6000                        |
| SDWL1005C6N2□STF | 6.2        | B,C,S,D,J,K | 25                  | 250            | 0.078              | 710                | >6000                        |
| SDWL1005C6N8□STF | 6.8        | G,H,J,K     | 24                  | 250            | 0.105              | 610                | 6000                         |
| SDWL1005C7N5□STF | 7.5        | G,H,J,K     | 25                  | 250            | 0.12               | 570                | 6000                         |
| SDWL1005C8N2□STF | 8.2        | G,H,J,K     | 25                  | 250            | 0.11               | 590                | 5500                         |
| SDWL1005C8N7□STF | 8.7        | G,H,J,K     | 25                  | 250            | 0.11               | 590                | 5500                         |
| SDWL1005C9N0□STF | 9.0        | G, H, J, K  | 25                  | 250            | 0.11               | 590                | 5500                         |

## SPECIFICATIONS

### SDWL1005C-S TYPE

| Part Number      | Inductance | Tolerance  | Min. Quality Factor | L/Q Test Freq. | Max. DC Resistance | Max. Rated Current | Min. Self-resonant Frequency |
|------------------|------------|------------|---------------------|----------------|--------------------|--------------------|------------------------------|
| Units            | nH         | -          | -                   | MHz            | $\Omega$           | mA                 | MHz                          |
| Symbol           | L          | -          | Q                   | Freq.          | DCR                | I <sub>r</sub>     | S.R.F                        |
| SDWL1005C9N1□STF | 9.1        | G,H,J,K    | 25                  | 250            | 0.11               | 590                | 5500                         |
| SDWL1005C10N□STF | 10         | G,H,J,K    | 24                  | 250            | 0.15               | 510                | 5500                         |
| SDWL1005C11N□STF | 11         | G,H,J,K    | 26                  | 250            | 0.12               | 570                | 5500                         |
| SDWL1005C12N□STF | 12         | G,H,J,K    | 26                  | 250            | 0.12               | 570                | 5500                         |
| SDWL1005C13N□STF | 13         | G,H,J,K    | 24                  | 250            | 0.18               | 460                | 5000                         |
| SDWL1005C14N□STF | 14         | G,H,J,K    | 26                  | 250            | 0.21               | 430                | 5000                         |
| SDWL1005C15N□STF | 15         | G,H,J,K    | 26                  | 250            | 0.21               | 430                | 5000                         |
| SDWL1005C16N□STF | 16         | G,H,J,K    | 25                  | 250            | 0.28               | 370                | 4500                         |
| SDWL1005C18N□STF | 18         | G,H,J,K    | 25                  | 250            | 0.28               | 370                | 4500                         |
| SDWL1005C19N□STF | 19         | G,H,J,K    | 26                  | 250            | 0.24               | 400                | 4000                         |
| SDWL1005C20N□STF | 20         | G,H,J,K    | 26                  | 250            | 0.24               | 400                | 4000                         |
| SDWL1005C22N□STF | 22         | G,H,J,K    | 25                  | 250            | 0.36               | 330                | 4000                         |
| SDWL1005C23N□STF | 23         | G,H,J,K    | 25                  | 250            | 0.36               | 330                | 3800                         |
| SDWL1005C24N□STF | 24         | G,H,J,K    | 25                  | 250            | 0.36               | 330                | 3500                         |
| SDWL1005C27N□STF | 27         | G,H,J,K    | 25                  | 250            | 0.38               | 320                | 3500                         |
| SDWL1005C30N□STF | 30         | G,H,J,K    | 25                  | 250            | 0.38               | 320                | 3300                         |
| SDWL1005C33N□STF | 33         | G,H,J,K    | 24                  | 250            | 0.55               | 260                | 3200                         |
| SDWL1005C36N□STF | 36         | G,H,J,K    | 25                  | 250            | 0.60               | 250                | 3100                         |
| SDWL1005C38N□STF | 38         | G,H,J,K    | 25                  | 250            | 0.60               | 250                | 3000                         |
| SDWL1005C39N□STF | 39         | G,H,J,K    | 25                  | 250            | 0.60               | 250                | 3000                         |
| SDWL1005C43N□STF | 43         | G,H,J,K    | 25                  | 250            | 0.68               | 240                | 3000                         |
| SDWL1005C47N□STF | 47         | G,H,J,K    | 25                  | 250            | 0.95               | 200                | 2900                         |
| SDWL1005C51N□STF | 51         | G,H,J,K    | 25                  | 250            | 0.95               | 200                | 2850                         |
| SDWL1005C56N□STF | 56         | G,H,J,K    | 25                  | 250            | 1.05               | 190                | 2800                         |
| SDWL1005C62N□STF | 62         | G,H,J,K    | 25                  | 250            | 1.05               | 190                | 2600                         |
| SDWL1005C68N□STF | 68         | G,H,J,K    | 25                  | 250            | 1.35               | 170                | 2500                         |
| SDWL1005C75N□STF | 75         | G,H,J,K    | 24                  | 250            | 1.75               | 140                | 2400                         |
| SDWL1005C82N□STF | 82         | G,H,J,K    | 25                  | 250            | 1.90               | 140                | 2300                         |
| SDWL1005C91N□STF | 91         | G,H,J,K    | 25                  | 250            | 1.95               | 140                | 2100                         |
| SDWL1005C96N□STF | 96         | G, H, J, K | 24                  | 250            | 2.06               | 130                | 1500                         |
| SDWL1005CR10□STF | 100        | G,H,J,K    | 24                  | 250            | 2.06               | 130                | 1500                         |
| SDWL1005CR11□STF | 110        | G,H,J,K    | 25                  | 250            | 2.38               | 120                | 1200                         |
| SDWL1005CR12□STF | 120        | G,H,J,K    | 25                  | 250            | 2.66               | 110                | 1000                         |

### SDWL1608C-S TYPE

| Part Number      | Inductance | Tolerance | Min. Quality Factor | L/Q Test Freq. | Max. DC Resistance | Max. Rated Current | Min. Self-resonant Frequency |
|------------------|------------|-----------|---------------------|----------------|--------------------|--------------------|------------------------------|
| Units 单位         | nH         | -         | -                   | MHz            | $\Omega$           | mA                 | MHz                          |
| Symbol 符号        | L          | -         | Q                   | Freq.          | DCR                | I <sub>r</sub>     | S.R.F                        |
| SDWL1608C1N6□STF | 1.6        | S, K      | 22                  | 250            | 0.035              | 1150               | >6000                        |
| SDWL1608C1N7□STF | 1.7        | C,S,D,J,K | 16                  | 250            | 0.043              | 1000               | >6000                        |
| SDWL1608C1N8□STF | 1.8        | C,S,D,J,K | 18                  | 250            | 0.043              | 1000               | >6000                        |
| SDWL1608C2N2□STF | 2.2        | S, D,K    | 13                  | 250            | 0.150              | 700                | >6000                        |
| SDWL1608C2N7□STF | 2.7        | C,S,D,J,K | 25                  | 250            | 0.043              | 1000               | >6000                        |
| SDWL1608C3N3□STF | 3.3        | C,S,D,J,K | 25                  | 250            | 0.059              | 850                | >6000                        |
| SDWL1608C3N6□STF | 3.6        | C,S,D,J,K | 25                  | 250            | 0.059              | 850                | >6000                        |

# SPECIFICATIONS

## SDWL1608C-S TYPE

| Part Number      | Inductance | Tolerance  | Min. Quality Factor | L/Q Test Freq. | Max. DC Resistance | Max. Rated Current | Min. Self-resonant Frequency |
|------------------|------------|------------|---------------------|----------------|--------------------|--------------------|------------------------------|
| Units            | nH         | -          | -                   | MHz            | $\Omega$           | mA                 | MHz                          |
| Symbol           | L          | -          | Q                   | Freq.          | DCR                | I <sub>r</sub>     | S.R.F                        |
| SDWL1608C3N9□STF | 3.9        | C,S,D,J,K  | 25                  | 250            | 0.059              | 850                | >6000                        |
| SDWL1608C4N3□STF | 4.3        | C,S,D,J,K  | 25                  | 250            | 0.059              | 850                | >6000                        |
| SDWL1608C4N7□STF | 4.7        | C,S,D,J,K  | 25                  | 250            | 0.065              | 800                | >6000                        |
| SDWL1608C5N1□STF | 5.1        | C,S,D,J,K  | 21                  | 250            | 0.130              | 600                | >6000                        |
| SDWL1608C6N2□STF | 6.2        | C,S,D,J,K  | 29                  | 250            | 0.095              | 700                | >6000                        |
| SDWL1608C6N8□STF | 6.8        | G,H,J,K    | 29                  | 250            | 0.095              | 700                | >6000                        |
| SDWL1608C7N5□STF | 7.5        | G,H,J,K    | 33                  | 250            | 0.095              | 700                | >6000                        |
| SDWL1608C8N2□STF | 8.2        | G,H,J,K    | 31                  | 250            | 0.095              | 700                | >6000                        |
| SDWL1608C8N7□STF | 8.7        | G,H,J,K    | 31                  | 250            | 0.095              | 700                | >6000                        |
| SDWL1608C9N1□STF | 9.1        | G,H,J,K    | 30                  | 250            | 0.120              | 620                | 6000                         |
| SDWL1608C9N5□STF | 9.5        | G,H,J,K    | 26                  | 250            | 0.160              | 540                | 6000                         |
| SDWL1608C10N□STF | 10         | G,H,J,K    | 30                  | 250            | 0.130              | 600                | 6000                         |
| SDWL1608C11N□STF | 11         | G,H,J,K    | 35                  | 250            | 0.130              | 600                | 6000                         |
| SDWL1608C12N□STF | 12         | G,H,J,K    | 35                  | 250            | 0.130              | 600                | 6000                         |
| SDWL1608C13N□STF | 13         | G,H,J,K    | 35                  | 250            | 0.130              | 600                | 6000                         |
| SDWL1608C15N□STF | 15         | G,H,J,K    | 37                  | 250            | 0.150              | 550                | 6000                         |
| SDWL1608C16N□STF | 16         | G,H,J,K    | 37                  | 250            | 0.150              | 550                | 5500                         |
| SDWL1608C17N□STF | 17         | G, H, J, K | 37                  | 250            | 0.150              | 550                | 5500                         |
| SDWL1608C18N□STF | 18         | G,H,J,K    | 37                  | 250            | 0.150              | 550                | 5500                         |
| SDWL1608C20N□STF | 20         | G,H,J,K    | 37                  | 250            | 0.150              | 550                | 4900                         |
| SDWL1608C22N□STF | 22         | G,H,J,K    | 38                  | 250            | 0.190              | 490                | 4600                         |
| SDWL1608C23N□STF | 23         | G,H,J,K    | 40                  | 250            | 0.190              | 490                | 3800                         |
| SDWL1608C24N□STF | 24         | G,H,J,K    | 40                  | 250            | 0.190              | 490                | 3800                         |
| SDWL1608C25N□STF | 25         | G,H,J,K    | 40                  | 250            | 0.190              | 490                | 3700                         |
| SDWL1608C27N□STF | 27         | G,H,J,K    | 38                  | 250            | 0.190              | 490                | 3700                         |
| SDWL1608C30N□STF | 30         | G,H,J,K    | 38                  | 250            | 0.210              | 470                | 3300                         |
| SDWL1608C33N□STF | 33         | G,H,J,K    | 40                  | 250            | 0.210              | 470                | 3200                         |
| SDWL1608C36N□STF | 36         | G,H,J,K    | 40                  | 250            | 0.220              | 460                | 2900                         |
| SDWL1608C39N□STF | 39         | G,H,J,K    | 40                  | 250            | 0.220              | 460                | 2800                         |
| SDWL1608C43N□STF | 43         | G,H,J,K    | 40                  | 250            | 0.270              | 400                | 2700                         |
| SDWL1608C47N□STF | 47         | G,H,J,K    | 36                  | 200            | 0.270              | 400                | 2600                         |
| SDWL1608C51N□STF | 51         | G,H,J,K    | 35                  | 200            | 0.300              | 390                | 2400                         |
| SDWL1608C56N□STF | 56         | G,H,J,K    | 38                  | 200            | 0.350              | 360                | 2400                         |
| SDWL1608C62N□STF | 62         | G,H,J,K    | 36                  | 200            | 0.380              | 350                | 2300                         |
| SDWL1608C68N□STF | 68         | G,H,J,K    | 36                  | 200            | 0.380              | 350                | 2200                         |
| SDWL1608C72N□STF | 72         | G,H,J,K    | 34                  | 150            | 0.430              | 320                | 2100                         |
| SDWL1608C82N□STF | 82         | G,H,J,K    | 34                  | 150            | 0.500              | 300                | 2000                         |
| SDWL1608C90N□STF | 90         | G, H, J, K | 34                  | 150            | 0.520              | 300                | 1900                         |
| SDWL1608C91N□STF | 91         | G,H,J,K    | 34                  | 150            | 0.520              | 300                | 1900                         |
| SDWL1608CR10□STF | 100        | G,H,J,K    | 31                  | 150            | 0.660              | 260                | 1800                         |
| SDWL1608CR11□STF | 110        | G,H,J,K    | 32                  | 150            | 0.730              | 250                | 1700                         |
| SDWL1608CR12□STF | 120        | G,H,J,K    | 32                  | 150            | 0.750              | 240                | 1600                         |
| SDWL1608CR13□STF | 130        | G, H, J, K | 32                  | 150            | 0.750              | 240                | 1500                         |
| SDWL1608CR14□STF | 140        | G, H, J, K | 32                  | 150            | 1.100              | 200                | 1400                         |
| SDWL1608CR15□STF | 150        | G, H,J,K   | 32                  | 150            | 1.120              | 200                | 1400                         |
| SDWL1608CR16□STF | 160        | G,H,J,K    | 32                  | 150            | 1.120              | 200                | 1400                         |
| SDWL1608CR18□STF | 180        | G,H,J,K    | 25                  | 100            | 1.380              | 180                | 1300                         |
| SDWL1608CR20□STF | 200        | G,H,J,K    | 25                  | 100            | 1.900              | 150                | 1250                         |

## SPECIFICATIONS

### SDWL1608C-S TYPE

| Part Number      | Inductance | Tolerance  | Min. Quality Factor | L/Q Test Freq. | Max. DC Resistance | Max. Rated Current | Min. Self-resonant Frequency |
|------------------|------------|------------|---------------------|----------------|--------------------|--------------------|------------------------------|
| Units            | nH         | -          | -                   | MHz            | Ω                  | mA                 | MHz                          |
| Symbol           | L          | -          | Q                   | Freq.          | DCR                | Ir                 | S.R.F                        |
| SDWL1608CR22□STF | 220        | G,H,J,K    | 25                  | 100            | 2.100              | 140                | 1200                         |
| SDWL1608CR24□STF | 240        | G,H,J,K    | 25                  | 100            | 2.750              | 120                | 1100                         |
| SDWL1608CR25□STF | 250        | G,H,J,K    | 25                  | 100            | 2.800              | 120                | 1100                         |
| SDWL1608CR27□STF | 270        | G,H,J,K    | 26                  | 100            | 3.000              | 120                | 960                          |
| SDWL1608CR30□STF | 300        | G, H, J, K | 26                  | 100            | 4.050              | 110                | 900                          |
| SDWL1608CR33□STF | 330        | G,H,J,K    | 26                  | 100            | 4.200              | 100                | 800                          |
| SDWL1608CR39□STF | 390        | G,H,J,K    | 27                  | 100            | 4.500              | 100                | 800                          |
| SDWL1608CR42□STF | 420        | G,H,J,K    | 27                  | 100            | 5.400              | 90                 | 800                          |
| SDWL1608CR47□STF | 470        | G,H,J,K    | 27                  | 100            | 5.700              | 90                 | 700                          |
| SDWL1608CR56□STF | 560        | G,H,J,K    | 27                  | 100            | 8.100              | 70                 | 650                          |

### SDWL2012C TYPE

| Part Number      | Inductance | Tolerance | Min. Quality Factor | L/Q Test Freq. | Max. DC Resistance | Max. Rated Current | Min. Self-resonant Frequency |
|------------------|------------|-----------|---------------------|----------------|--------------------|--------------------|------------------------------|
| Units            | nH         | -         | -                   | MHz            | Ω                  | mA                 | MHz                          |
| Symbol           | L          | -         | Q                   | Freq.          | DCR                | Ir                 | S.R.F                        |
| SDWL2012C2N2□◎TF | 2.2        | G,H,J,K   | 40                  | 250/1500       | 0.10               | 600                | >6000                        |
| SDWL2012C3N3□◎TF | 3.3        | G,H,J,K   | 25                  | 250/1500       | 0.20               | 600                | >6000                        |
| SDWL2012C6N8□◎TF | 6.8        | G,H,J,K   | 40                  | 250/1000       | 0.11               | 600                | 5000                         |
| SDWL2012C8N2□◎TF | 8.2        | G,H,J,K   | 40                  | 250/1000       | 0.19               | 600                | 4600                         |
| SDWL2012C12N□◎TF | 12         | G,H,J,K   | 40                  | 250/500        | 0.15               | 600                | 4000                         |
| SDWL2012C15N□◎TF | 15         | G,H,J,K   | 40                  | 250/500        | 0.17               | 600                | 2900                         |
| SDWL2012C18N□◎TF | 18         | G,H,J,K   | 50                  | 250/500        | 0.20               | 600                | 3300                         |
| SDWL2012C22N□◎TF | 22         | G,H,J,K   | 55                  | 250/500        | 0.22               | 500                | 2000                         |
| SDWL2012C27N□◎TF | 27         | G,H,J,K   | 55                  | 250/500        | 0.25               | 500                | 2500                         |
| SDWL2012C33N□◎TF | 33         | G,H,J,K   | 60                  | 250/500        | 0.27               | 500                | 2000                         |
| SDWL2012C39N□◎TF | 39         | G,H,J,K   | 60                  | 250/500        | 0.29               | 500                | 2000                         |
| SDWL2012C47N□◎TF | 47         | G,H,J,K   | 50                  | 200/500        | 0.31               | 500                | 1600                         |
| SDWL2012C56N□◎TF | 56         | G,H,J,K   | 55                  | 200/500        | 0.32               | 500                | 1550                         |
| SDWL2012C68N□◎TF | 68         | G,H,J,K   | 55                  | 200/500        | 0.38               | 500                | 1450                         |
| SDWL2012C82N□◎TF | 82         | G,H,J,K   | 50                  | 150/500        | 0.42               | 400                | 1300                         |
| SDWL2012CR10□◎TF | 100        | G,H,J,K   | 50                  | 150/500        | 0.46               | 400                | 1200                         |
| SDWL2012CR12□◎TF | 120        | G,H,J,K   | 50                  | 150/250        | 0.51               | 400                | 1100                         |
| SDWL2012CR15□◎TF | 150        | G,H,J,K   | 50                  | 100/250        | 0.56               | 400                | 920                          |
| SDWL2012CR18□◎TF | 180        | G,H,J,K   | 50                  | 100/250        | 0.64               | 400                | 870                          |
| SDWL2012CR22□◎TF | 220        | G,H,J,K   | 45                  | 100/250        | 1.10               | 400                | 850                          |
| SDWL2012CR27□◎TF | 270        | G,H,J,K   | 38                  | 100/250        | 1.00               | 350                | 650                          |
| SDWL2012CR33□◎TF | 330        | G,H,J,K   | 40                  | 100/250        | 1.40               | 310                | 600                          |
| SDWL2012CR39□◎TF | 390        | G,H,J,K   | 35                  | 100/250        | 1.50               | 290                | 560                          |
| SDWL2012CR47□◎TF | 470        | G,H,J,K   | 33                  | 50/100         | 1.72               | 250                | 375                          |
| SDWL2012CR56□◎TF | 560        | G,H,J,K   | 23                  | 25/50          | 1.90               | 230                | 320                          |
| SDWL2012CR62□◎TF | 620        | G,H,J,K   | 23                  | 25/50          | 1.95               | 200                | 280                          |
| SDWL2012CR68□◎TF | 680        | G,H,J,K   | 23                  | 25/50          | 2.05               | 190                | 270                          |
| SDWL2012CR75□◎TF | 750        | G,H,J,K   | 23                  | 25/50          | 2.10               | 180                | 240                          |
| SDWL2012CR82□◎TF | 820        | G,H,J,K   | 23                  | 25/50          | 2.30               | 180                | 250                          |
| SDWL2012CR91□◎TF | 910        | G,H,J,K   | 22                  | 25/50          | 2.40               | 160                | 230                          |
| SDWL2012C1R0□◎TF | 1000       | G,H,J,K   | 20                  | 25/50          | 2.50               | 150                | 200                          |

# SPECIFICATIONS

## SDWL2520C TYPE

| Part Number      | Inductance | Tolerance | Min. Quality Factor | L/Q Test Freq. | Max. DC Resistance | Max. Rated Current | Min. Self-resonant Frequency |
|------------------|------------|-----------|---------------------|----------------|--------------------|--------------------|------------------------------|
| Units 单位         | nH         | -         | -                   | MHz            | $\Omega$           | mA                 | MHz                          |
| Symbol 符号        | L          | -         | Q                   | Freq.          | DCR                | I <sub>r</sub>     | S.R.F                        |
| SDWL2520C4N7□◎TF | 4.7        | G,H,J,K   | 50                  | 50/1500        | 0.11               | 1000               | >6000                        |
| SDWL2520C10N□◎TF | 10         | G,H,J,K   | 50                  | 50/500         | 0.08               | 1000               | 4100                         |
| SDWL2520C12N□◎TF | 12         | G,H,J,K   | 50                  | 50/500         | 0.09               | 1000               | 3300                         |
| SDWL2520C15N□◎TF | 15         | G,H,J,K   | 50                  | 50/500         | 0.13               | 1000               | 2500                         |
| SDWL2520C18N□◎TF | 18         | G,H,J,K   | 50                  | 50/350         | 0.11               | 1000               | 2500                         |
| SDWL2520C22N□◎TF | 22         | G,H,J,K   | 55                  | 50/350         | 0.12               | 1000               | 2400                         |
| SDWL2520C27N□◎TF | 27         | G,H,J,K   | 55                  | 50/350         | 0.13               | 1000               | 1600                         |
| SDWL2520C33N□◎TF | 33         | G,H,J,K   | 60                  | 50/350         | 0.14               | 1000               | 1600                         |
| SDWL2520C39N□◎TF | 39         | G,H,J,K   | 50                  | 50/350         | 0.15               | 1000               | 1500                         |
| SDWL2520C47N□◎TF | 47         | G,H,J,K   | 65                  | 50/350         | 0.16               | 1000               | 1500                         |
| SDWL2520C56N□◎TF | 56         | G,H,J,K   | 50                  | 50/350         | 0.18               | 1000               | 1300                         |
| SDWL2520C68N□◎TF | 68         | G,H,J,K   | 65                  | 50/350         | 0.21               | 1000               | 1200                         |
| SDWL2520C82N□◎TF | 82         | G,H,J,K   | 60                  | 50/350         | 0.22               | 1000               | 800                          |
| SDWL2520CR10□◎TF | 100        | G,H,J,K   | 60                  | 25/350         | 0.56               | 650                | 1000                         |
| SDWL2520CR12□◎TF | 120        | G,H,J,K   | 60                  | 25/350         | 0.63               | 650                | 950                          |
| SDWL2520CR15□◎TF | 150        | G,H,J,K   | 50                  | 25/100         | 0.62               | 580                | 800                          |
| SDWL2520CR18□◎TF | 180        | G,H,J,K   | 50                  | 25/100         | 0.70               | 620                | 750                          |
| SDWL2520CR22□◎TF | 220        | G,H,J,K   | 50                  | 25/100         | 0.80               | 500                | 630                          |
| SDWL2520CR27□◎TF | 270        | G,H,J,K   | 50                  | 25/100         | 0.91               | 500                | 600                          |
| SDWL2520CR33□◎TF | 330        | G,H,J,K   | 50                  | 25/100         | 1.05               | 450                | 530                          |
| SDWL2520CR39□◎TF | 390        | G,H,J,K   | 50                  | 25/100         | 1.12               | 470                | 480                          |
| SDWL2520CR47□◎TF | 470        | G,H,J,K   | 50                  | 25/100         | 1.19               | 470                | 450                          |
| SDWL2520CR56□◎TF | 560        | G,H,J,K   | 50                  | 25/100         | 1.33               | 400                | 390                          |
| SDWL2520CR62□◎TF | 620        | G,H,J,K   | 45                  | 25/100         | 1.40               | 300                | 375                          |
| SDWL2520CR68□◎TF | 680        | G,H,J,K   | 45                  | 25/100         | 1.47               | 400                | 360                          |
| SDWL2520CR75□◎TF | 750        | G,H,J,K   | 45                  | 25/100         | 1.54               | 360                | 360                          |
| SDWL2520CR82□◎TF | 820        | G,H,J,K   | 45                  | 25/100         | 1.61               | 400                | 330                          |
| SDWL2520CR91□◎TF | 910        | G,H,J,K   | 35                  | 25/50          | 1.68               | 380                | 295                          |
| SDWL2520C1R0□◎TF | 1000       | G,H,J,K   | 35                  | 25/50          | 1.80               | 370                | 270                          |
| SDWL2520C1R2□◎TF | 1200       | G,H,J,K   | 35                  | 7.9/50         | 2.0                | 310                | 200                          |
| SDWL2520C1R5□◎TF | 1500       | G,H,J,K   | 28                  | 7.9/50         | 2.3                | 330                | 150                          |
| SDWL2520C1R8□◎TF | 1800       | G,H,J,K   | 28                  | 7.9/50         | 2.6                | 300                | 120                          |
| SDWL2520C2R2□◎TF | 2200       | G,H,J,K   | 28                  | 7.9/50         | 2.8                | 280                | 100                          |
| SDWL2520C2R7□◎TF | 2700       | G,H,J,K   | 22                  | 7.9/25         | 3.2                | 290                | 90                           |
| SDWL2520C3R3□◎TF | 3300       | G,H,J,K   | 22                  | 7.9/25         | 3.4                | 290                | 70                           |
| SDWL2520C3R9□◎TF | 3900       | G,H,J,K   | 17                  | 7.9/25         | 3.6                | 260                | 60                           |
| SDWL2520C4R7□◎TF | 4700       | G,H,J,K   | 20                  | 7.9/25         | 4.0                | 260                | 50                           |
| SDWL2520C5R6□◎TF | 5600       | G,H,J,K   | 20                  | 7.9/25         | 5.7                | 240                | 40                           |
| SDWL2520C6R8□◎TF | 6800       | G,H,J,K   | 20                  | 7.9/25         | 7.7                | 200                | 40                           |
| SDWL2520C8R2□◎TF | 8200       | G,H,J,K   | 20                  | 7.9/25         | 10.7               | 150                | 30                           |

# SPECIFICATIONS

## SDWL3216C TYPE

| Part Number      | Inductance | Tolerance | Min. Quality Factor | L/Q Test Freq. | Max. DC Resistance | Max. Rated Current | Min. Self-resonant Frequency |
|------------------|------------|-----------|---------------------|----------------|--------------------|--------------------|------------------------------|
| Units            | nH         | -         | -                   | MHz            | $\Omega$           | mA                 | MHz                          |
| Symbol           | L          | -         | Q                   | Freq.          | DCR                | I <sub>r</sub>     | S.R.F                        |
| SDWL3216C3N3□◎TF | 3.3        | G,H,J,K   | 20                  | 100/300        | 0.07               | 1000               | 6200                         |
| SDWL3216C6N8□◎TF | 6.8        | G,H,J,K   | 30                  | 100/300        | 0.07               | 1000               | 5500                         |
| SDWL3216C10N□◎TF | 10         | G,H,J,K   | 40                  | 100/300        | 0.09               | 1000               | 4000                         |
| SDWL3216C12N□◎TF | 12         | G,H,J,K   | 40                  | 100/300        | 0.09               | 1000               | 3200                         |
| SDWL3216C15N□◎TF | 15         | G,H,J,K   | 40                  | 100/300        | 0.12               | 1000               | 3200                         |
| SDWL3216C18N□◎TF | 18         | G,H,J,K   | 45                  | 100/300        | 0.12               | 1000               | 2800                         |
| SDWL3216C22N□◎TF | 22         | G,H,J,K   | 50                  | 100/300        | 0.12               | 1000               | 2200                         |
| SDWL3216C27N□◎TF | 27         | G,H,J,K   | 50                  | 100/300        | 0.12               | 1000               | 1800                         |
| SDWL3216C33N□◎TF | 33         | G,H,J,K   | 50                  | 100/300        | 0.12               | 1000               | 1800                         |
| SDWL3216C39N□◎TF | 39         | G,H,J,K   | 50                  | 100/300        | 0.12               | 1000               | 1800                         |
| SDWL3216C47N□◎TF | 47         | G,H,J,K   | 50                  | 100/300        | 0.13               | 1000               | 1500                         |
| SDWL3216C56N□◎TF | 56         | G,H,J,K   | 55                  | 100/300        | 0.14               | 1000               | 1450                         |
| SDWL3216C68N□◎TF | 68         | G,H,J,K   | 55                  | 100/300        | 0.26               | 900                | 1200                         |
| SDWL3216C82N□◎TF | 82         | G,H,J,K   | 55                  | 100/300        | 0.21               | 900                | 1200                         |
| SDWL3216CR10□◎TF | 100        | G,H,J,K   | 55                  | 100/300        | 0.30               | 850                | 1100                         |
| SDWL3216CR12□◎TF | 120        | G,H,J,K   | 60                  | 100/300        | 0.30               | 800                | 1100                         |
| SDWL3216CR15□◎TF | 150        | G,H,J,K   | 55                  | 100/300        | 0.31               | 750                | 950                          |
| SDWL3216CR18□◎TF | 180        | G,H,J,K   | 60                  | 50/300         | 0.43               | 700                | 900                          |
| SDWL3216CR22□◎TF | 220        | G,H,J,K   | 60                  | 50/300         | 0.56               | 670                | 760                          |
| SDWL3216CR27□◎TF | 270        | G,H,J,K   | 50                  | 50/300         | 0.56               | 630                | 730                          |
| SDWL3216CR33□◎TF | 330        | G,H,J,K   | 45                  | 50/150         | 0.70               | 590                | 650                          |
| SDWL3216CR39□◎TF | 390        | G,H,J,K   | 45                  | 50/150         | 0.80               | 530                | 600                          |
| SDWL3216CR47□◎TF | 470        | G,H,J,K   | 45                  | 50/150         | 1.30               | 490                | 550                          |
| SDWL3216CR56□◎TF | 560        | G,H,J,K   | 45                  | 35/150         | 1.34               | 460                | 470                          |
| SDWL3216CR68□◎TF | 680        | G,H,J,K   | 45                  | 35/150         | 1.58               | 430                | 450                          |
| SDWL3216CR82□◎TF | 820        | G,H,J,K   | 45                  | 35/150         | 1.82               | 400                | 420                          |
| SDWL3216C1R0□◎TF | 1000       | G,H,J,K   | 45                  | 35/150         | 2.80               | 320                | 400                          |
| SDWL3216C1R2□◎TF | 1200       | G,H,J,K   | 45                  | 35/150         | 3.20               | 300                | 380                          |

## SDWL3225C TYPE

| Part Number      | Inductance | Tolerance | Min. Quality Factor | L/Q Test Freq. | Max. DC Resistance | Max. Rated Current | Min. Self-resonant Frequency |
|------------------|------------|-----------|---------------------|----------------|--------------------|--------------------|------------------------------|
| Units            | nH         | -         | -                   | MHz            | $\Omega$           | mA                 | MHz                          |
| Symbol           | L          | -         | Q                   | Freq.          | DCR                | I <sub>r</sub>     | S.R.F                        |
| SDWL3225C3N9□◎TF | 3.9        | G,H,J,K   | 30                  | 100/300        | 0.05               | 1000               | 6000                         |
| SDWL3225C4N7□◎TF | 4.7        | G,H,J,K   | 30                  | 100/300        | 0.065              | 1000               | 5800                         |
| SDWL3225C8N2□◎TF | 8.2        | G,H,J,K   | 30                  | 100/300        | 0.07               | 1000               | 5500                         |
| SDWL3225C10N□◎TF | 10         | G,H,J,K   | 40                  | 100/300        | 0.08               | 1000               | 4000                         |
| SDWL3225C12N□◎TF | 12         | G,H,J,K   | 40                  | 100/300        | 0.08               | 1000               | 3200                         |
| SDWL3225C15N□◎TF | 15         | G,H,J,K   | 40                  | 100/300        | 0.10               | 1000               | 3200                         |
| SDWL3225C18N□◎TF | 18         | G,H,J,K   | 50                  | 100/300        | 0.10               | 1000               | 2800                         |
| SDWL3225C22N□◎TF | 22         | G,H,J,K   | 50                  | 100/300        | 0.10               | 1000               | 2200                         |
| SDWL3225C27N□◎TF | 27         | G,H,J,K   | 50                  | 100/300        | 0.11               | 1000               | 1800                         |
| SDWL3225C33N□◎TF | 33         | G,H,J,K   | 55                  | 100/300        | 0.11               | 1000               | 1800                         |
| SDWL3225C39N□◎TF | 39         | G,H,J,K   | 55                  | 100/300        | 0.12               | 1000               | 1500                         |
| SDWL3225C43N□◎TF | 43         | G,H,J,K   | 55                  | 100/300        | 0.12               | 1000               | 1500                         |



## SPECIFICATIONS

### SDWL3225C TYPE

| Part Number      | Inductance | Tolerance | Min. Quality Factor | L/Q Test Freq. | Max. DC Resistance | Max. Rated Current | Min. Self-resonant Frequency |
|------------------|------------|-----------|---------------------|----------------|--------------------|--------------------|------------------------------|
| Units            | nH         | -         | -                   | MHz            | $\Omega$           | mA                 | MHz                          |
| Symbol           | L          | -         | Q                   | Freq.          | DCR                | I <sub>r</sub>     | S.R.F                        |
| SDWL3225C47N□◎TF | 47         | G,H,J,K   | 55                  | 100/300        | 0.13               | 1000               | 1500                         |
| SDWL3225C56N□◎TF | 56         | G,H,J,K   | 55                  | 100/300        | 0.14               | 1000               | 1450                         |
| SDWL3225C68N□◎TF | 68         | G,H,J,K   | 55                  | 100/300        | 0.15               | 900                | 1200                         |
| SDWL3225C82N□◎TF | 82         | G,H,J,K   | 55                  | 100/300        | 0.20               | 900                | 1000                         |
| SDWL3225CR10□◎TF | 100        | G,H,J,K   | 55                  | 100/300        | 0.20               | 850                | 900                          |
| SDWL3225CR12□◎TF | 120        | G,H,J,K   | 60                  | 100/300        | 0.25               | 800                | 800                          |
| SDWL3225CR15□◎TF | 150        | G,H,J,K   | 60                  | 100/300        | 0.25               | 750                | 700                          |
| SDWL3225CR18□◎TF | 180        | G,H,J,K   | 60                  | 50/300         | 0.30               | 700                | 650                          |
| SDWL3225CR22□◎TF | 220        | G,H,J,K   | 60                  | 50/300         | 0.40               | 770                | 650                          |
| SDWL3225CR27□◎TF | 270        | G,H,J,K   | 40                  | 50/300         | 0.40               | 630                | 580                          |
| SDWL3225CR33□◎TF | 330        | G,H,J,K   | 45                  | 50/150         | 0.58               | 590                | 580                          |
| SDWL3225CR39□◎TF | 390        | G,H,J,K   | 45                  | 50/150         | 0.58               | 530                | 510                          |
| SDWL3225CR47□◎TF | 470        | G,H,J,K   | 45                  | 50/150         | 0.80               | 490                | 480                          |
| SDWL3225CR56□◎TF | 560        | G,H,J,K   | 45                  | 35/150         | 1.10               | 460                | 420                          |
| SDWL3225CR68□◎TF | 680        | G,H,J,K   | 45                  | 35/150         | 1.20               | 430                | 400                          |
| SDWL3225CR82□◎TF | 820        | G,H,J,K   | 45                  | 35/150         | 1.82               | 400                | 370                          |
| SDWL3225C1R0□◎TF | 1000       | G,H,J,K   | 45                  | 35/150         | 1.85               | 320                | 340                          |
| SDWL3225C1R2□◎TF | 1200       | G,H,J,K   | 35                  | 35/150         | 1.87               | 300                | 220                          |
| SDWL3225C1R5□◎TF | 1500       | G,H,J,K   | 20                  | 7.9/50         | 1.95               | 310                | 160                          |
| SDWL3225C1R8□◎TF | 1800       | G,H,J,K   | 30                  | 7.9/50         | 2.25               | 310                | 160                          |
| SDWL3225C2R2□◎TF | 2200       | G,H,J,K   | 25                  | 7.9/50         | 2.41               | 310                | 130                          |
| SDWL3225C2R7□◎TF | 2700       | G,H,J,K   | 25                  | 7.9/50         | 2.85               | 300                | 110                          |
| SDWL3225C3R0□◎TF | 3000       | G,H,J,K   | 20                  | 7.9/25         | 3.12               | 300                | 110                          |
| SDWL3225C3R9□◎TF | 3900       | G,H,J,K   | 20                  | 7.9/25         | 3.60               | 290                | 60                           |
| SDWL3225C4R7□◎TF | 4700       | G,H,J,K   | 20                  | 7.9/25         | 4.00               | 280                | 60                           |
| SDWL3225C5R6□◎TF | 5600       | G,H,J,K   | 15                  | 7.9/25         | 5.00               | 250                | 50                           |
| SDWL3225C6R8□◎TF | 6800       | G,H,J,K   | 15                  | 7.9            | 8.00               | 230                | 40                           |
| SDWL3225C8R6□◎TF | 8600       | G,H,J,K   | 15                  | 7.9            | 9.00               | 200                | 40                           |

### SDWL4532C TYPE

| Part Number      | Inductance | Tolerance | Min. Quality Factor | L/Q Test Freq. | Max. DC Resistance | Max. Rated Current | Min. Self-resonant Frequency |
|------------------|------------|-----------|---------------------|----------------|--------------------|--------------------|------------------------------|
| Units            | $\mu$ H    | -         | -                   | MHz            | $\Omega$           | mA                 | MHz                          |
| Symbol           | L          | -         | Q                   | Freq.          | DCR                | I <sub>r</sub>     | S.R.F                        |
| SDWL4532C1R0□◎TF | 1.0        | G,H,J,K   | 60                  | 7.9/50         | 1.2                | 480                | 250                          |
| SDWL4532C1R2□◎TF | 1.2        | G,H,J,K   | 60                  | 7.9/50         | 1.2                | 480                | 230                          |
| SDWL4532C1R5□◎TF | 1.5        | G,H,J,K   | 60                  | 7.9/50         | 1.6                | 430                | 210                          |
| SDWL4532C1R8□◎TF | 1.8        | G,H,J,K   | 55                  | 7.9/50         | 2.0                | 380                | 150                          |
| SDWL4532C2R2□◎TF | 2.2        | G,H,J,K   | 55                  | 7.9/50         | 2.2                | 340                | 150                          |
| SDWL4532C2R7□◎TF | 2.7        | G,H,J,K   | 55                  | 7.9/50         | 3.2                | 300                | 150                          |
| SDWL4532C3R3□◎TF | 3.3        | G,H,J,K   | 55                  | 7.9/50         | 3.8                | 270                | 130                          |
| SDWL4532C3R9□◎TF | 3.9        | G,H,J,K   | 55                  | 7.9/50         | 5.0                | 240                | 120                          |
| SDWL4532C4R7□◎TF | 4.7        | G,H,J,K   | 55                  | 7.9/50         | 5.4                | 230                | 90                           |
| SDWL4532C5R6□◎TF | 5.6        | G,H,J,K   | 45                  | 7.9/50         | 5.7                | 220                | 90                           |
| SDWL4532C6R8□◎TF | 6.8        | G,H,J,K   | 30                  | 7.9/50         | 6.6                | 210                | 80                           |
| SDWL4532C8R2□◎TF | 8.2        | G,H,J,K   | 20                  | 7.9/50         | 7.0                | 200                | 70                           |



# SPECIFICATIONS

## SDWL4532C TYPE

| Part Number      | Inductance | Tolerance | Min. Quality Factor | L/Q Test Freq. | Max. DC Resistance | Max. Rated Current | Min. Self-resonant Frequency |
|------------------|------------|-----------|---------------------|----------------|--------------------|--------------------|------------------------------|
| Units            | uH         | -         | -                   | MHz            | $\Omega$           | mA                 | MHz                          |
| Symbol           | L          | -         | Q                   | Freq.          | DCR                | I <sub>r</sub>     | S.R.F                        |
| SDWL4532C100□◎TF | 10         | G,H,J,K   | 15                  | 7.9/50         | 7.7                | 190                | 60                           |
| SDWL4532C120□◎TF | 12         | G,H,J,K   | 30                  | 2.5/10         | 8.7                | 180                | 50                           |
| SDWL4532C150□◎TF | 15         | G,H,J,K   | 30                  | 2.5/10         | 9.6                | 170                | 30                           |
| SDWL4532C180□◎TF | 18         | G,H,J,K   | 25                  | 2.5/10         | 10.5               | 160                | 30                           |
| SDWL4532C220□◎TF | 22         | G,H,J,K   | 25                  | 2.5/10         | 11.5               | 155                | 20                           |
| SDWL4532C270□◎TF | 27         | G,H,J,K   | 25                  | 2.5/10         | 12.5               | 150                | 20                           |
| SDWL4532C330□◎TF | 33         | G,H,J,K   | 10                  | 2.5/10         | 13.5               | 145                | 10                           |

※□: Please specify the inductance tolerance code (B=±0.1nH, C=±0.2nH, S=±0.3nH, D=±0.5nH, G=±2%, H=±3%, J=±5%, K=±10%).

※◎: For the product of 2012 and above size, please specify the electrodes code: S means Sn Plating, G means Au Plating.

# TYPICAL ELECTRICAL CHARACTERISTICS

## SDWL1005C-S TYPE

Inductance vs. Frequency Characteristics

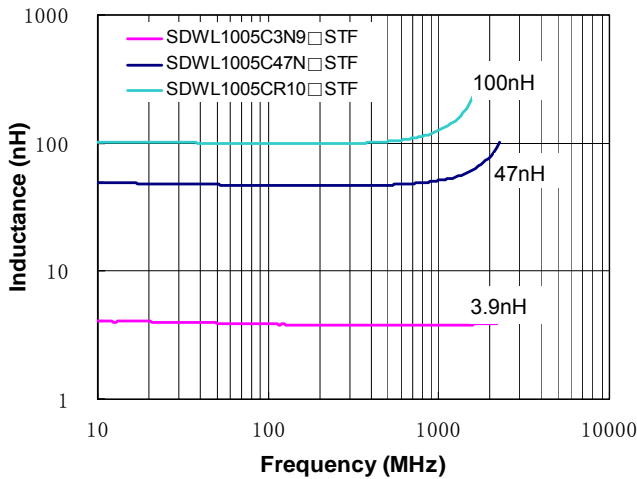

Q vs. Frequency Characteristics

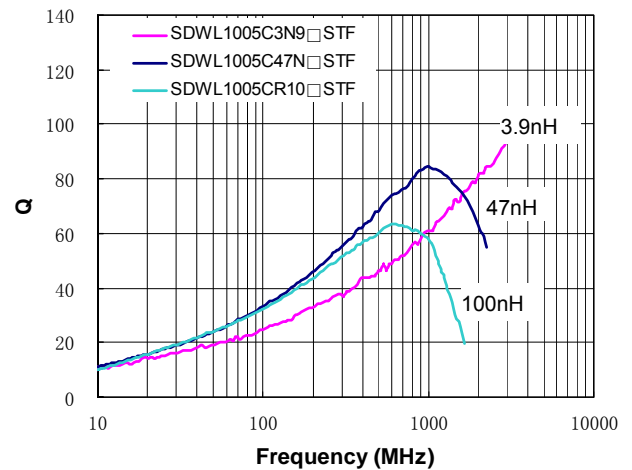

## SDWL1608C-S TYPE

Inductance vs. Frequency Characteristics



Q vs. Frequency Characteristics

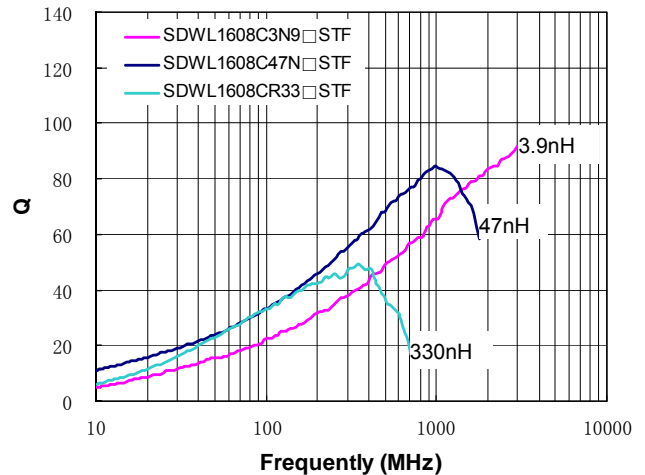

# TYPICAL ELECTRICAL CHARACTERISTICS

## SDWL2012C TYPE

Inductance vs. Frequency Characteristics



Q vs. Frequency Characteristics

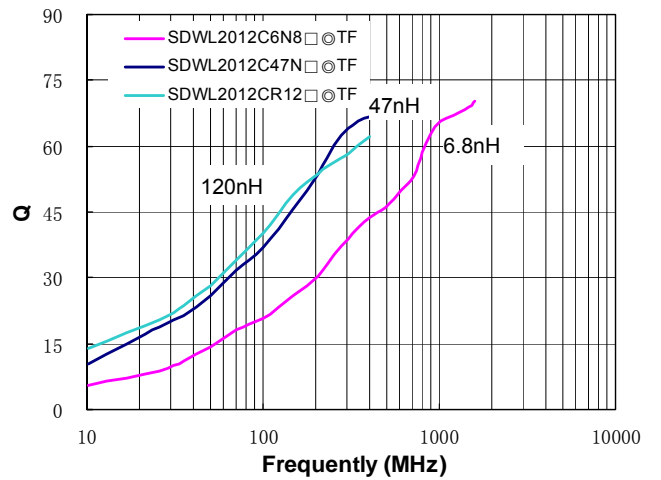

## SDWL2520C TYPE

Inductance vs. Frequency Characteristics



Q vs. Frequency Characteristics

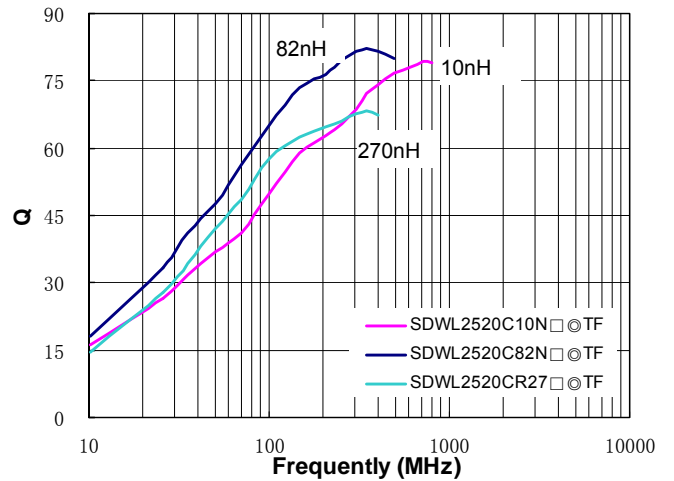

## SDWL3216C TYPE

Inductance vs. Frequency Characteristics



Q vs. Frequency Characteristics



# TYPICAL ELECTRICAL CHARACTERISTICS

## SDWL3225C TYPE

Inductance vs. Frequency Characteristics

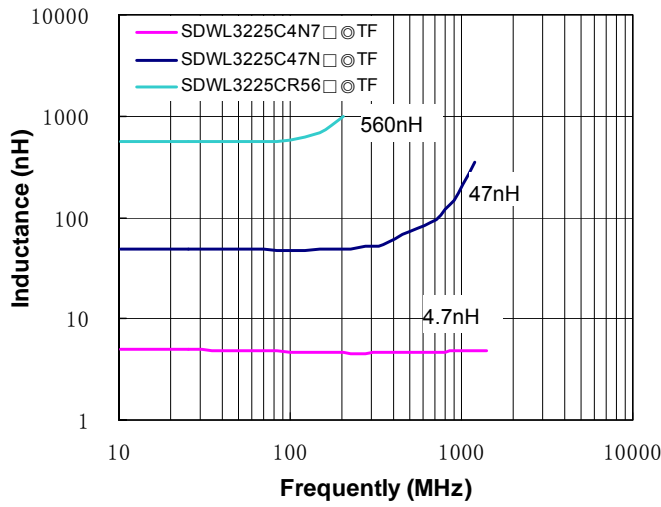

Q vs. Frequency Characteristics



## SDWL4532C TYPE

Inductance vs. Frequency Characteristics



Q vs. Frequency Characteristics

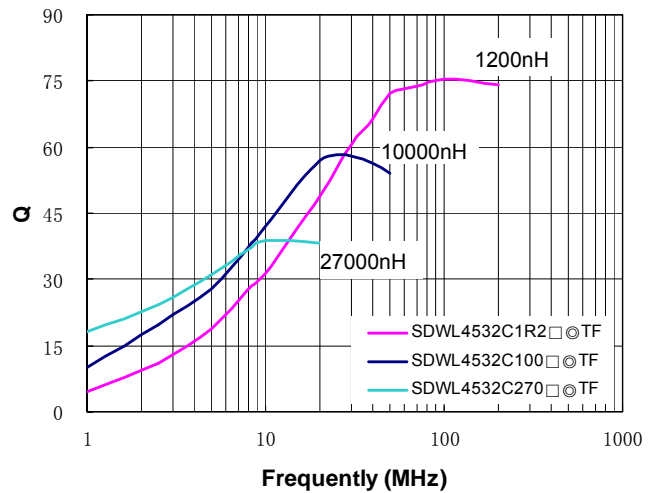

## X-ON Electronics

Largest Supplier of Electrical and Electronic Components

*Click to view similar products for [Fixed Inductors](#) category:*

*Click to view products by [Sunlord](#) manufacturer:*

Other Similar products are found below :

[CR32NP-100KC](#) [CR32NP-151KC](#) [CR32NP-180KC](#) [CR32NP-181KC](#) [CR32NP-1R5MC](#) [CR32NP-390KC](#) [CR32NP-3R9MC](#) [CR32NP-680KC](#) [CR32NP-820KC](#) [CR32NP-8R2MC](#) [CR43NP-390KC](#) [CR43NP-560KC](#) [CR43NP-680KC](#) [CR54NP-181KC](#) [CR54NP-470LC](#) [CR54NP-820KC](#) [CR54NP-8R5MC](#) [70F224AI](#) [MGDQ4-00004-P](#) [MHL1ECTTP18NJ](#) [MHQ1005P10NJ](#) [MHQ1005P1N0S](#) [MHQ1005P2N4S](#) [MHQ1005P3N6S](#) [MHQ1005P5N1S](#) [MHQ1005P8N2J](#) [PE-51506NL](#) [PE-53601NL](#) [PE-53602NL](#) [PE-53630NL](#) [PE-53824SNLT](#) [PE-92100NL](#) [PG0434.801NLT](#) [PG0936.113NLT](#) [9220-20](#) [9310-16](#) [PM06-2N7](#) [PM06-39NJ](#) [A01TK](#) [1206CS-471XJ](#) [HC2LP-R47-R](#) [HC2-R47-R](#) [HC3-2R2-R](#) [HCF1305-3R3-R](#) [1206CS-151XG](#) [RCH664NP-140L](#) [RCH664NP-4R7M](#) [RCH8011NP-221L](#) [RCP1317NP-332L](#) [RCP1317NP-391L](#)