

SPECIFICATIONS

Customer	
Product Name	Wire Wound Chip Ceramic Inductor
Sunlord Part Number	SDWL1608C <input type="checkbox"/> <input type="checkbox"/> <input type="checkbox"/> <input type="checkbox"/> STFN <input type="checkbox"/> <input type="checkbox"/>
Customer Part Number	

New Released, Revised]

SPEC No.: SDWL0912200000

【This SPEC is total 14 pages including specifications and appendix.】

【ROHS, Halogen-Free and SVHC Compliant Parts】

Approved By	Checked By	Issued By

Shenzhen Sunlord Electronics Co., Ltd.

Address: Sunlord Industrial Park, Dafuyuan Industrial Zone, Baoan, Shenzhen, China 518110
 Tel: 0086-755-29832333 Fax: 0086-755-82269029 E-Mail: sunlord@sunlordinc.com

【For Customer approval Only】

Date: _____

Qualification Status: Full Restricted Rejected

Approved By	Verified By	Re-checked By	Checked By

Comments:

【Version change history】

Rev.	Effective Date	Changed Contents	Change reasons	Approved By
01	/	New release	/	Jingxin Huang

Caution

All products listed in this specification are developed, designed and intended for use in general electronics equipment. The products are not designed or warranted to meet the requirements of the applications listed below, whose performance and/or quality require especially high reliability, or whose failure, malfunction or trouble might directly cause damage to society, person, or property. Please understand that we are not responsible for any damage or liability caused by use of the products in any of the applications below. Please contact us for more details if you intend to use our products in the following applications.

1. Aircraft equipment
2. Aerospace equipment
3. Undersea equipment
4. nuclear control equipment
5. military equipment
6. Power plant equipment
7. Medical equipment
8. Transportation equipment (automobiles, trains, ships,etc.)
9. Traffic signal equipment
10. Disaster prevention / crime prevention equipment
11. Data-processing equipment
12. Applications of similar complexity or with reliability requirements comparable to the applications listed in the above

【Precautions】

1. Magnetic materials shall be far away from parts to avoid impacts on their electrical characteristics.
2. Parts could be damaged by external mechanical pressure or stacked heavy objects, as well as strong shaking & dropping.
3. Please do not store parts in bulk to prevent coils and parts being damaged.
4. Oversized external force to parts on PCB may lead to parts being damaged or slipped off.
5. Please do not use parts on edge or top of PCB board in your design to avoid parts being damaged during PCB is moved.
6. Please use flux contained with resin since the highly acidic (Chlorine content more than 0.2 wt%) or water-soluble one could damage the insulation film of wires, then causing short circuit of parts.
7. Please do not use the brush to clean product or its surroundings. If you use the brush to clean product or its surroundings on PCB, copper wire may be broke, causing the product open .



1. Scope

This specification applies to the SDWL1608C□□□□STFN□□ of Wire Wound Chip Ceramic Inductor.

2. Product Description and Identification (Part Number)

1) Description

Wire Wound Chip Ceramic Inductor, 1608, XXX nH± X% @XXXMHz, XXXΩ, XXX Ma

2) Product Identification (Part Number)

SDWL **1608** **C** □□□□ □ **S** **I** **F** **N**□□
 ① ② ③ ④ ⑤ ⑥ ⑦ ⑧ ⑨

① Type	
SDWL	Wire Wound Chip Inductor

② External Dimensions [L X W] (mm)	
1608	1.6 X 0.8

③ Material Code	
C	Ceramic

④ Nominal Inductance (nH)	
Example	Nominal Value
1N8	1.8
10N	10
R10	100

⑤ Inductance Tolerance	
C	±0.2nH
S	±0.3nH
D	±0.5nH
G	±2%
H	±3%
J	±5%
K	±10%

⑥ Product Classification Code	
S	Sn Plating Five-faces Coating

⑦ Packing	
B	Bulk Package
T	Tape & Reel

⑧ HSF Products	
Hazardous Substance Free Products	

⑨ Internal Code	
N01	

3. Electrical Characteristics

Please refer to **Appendix A**.

- 1) Operating and storage temperature range (individual chip without packing): -40°C to +125°C
- 2) Storage temperature range (packaging conditions): -10°C~+40°C and RH 70% (Max.)

4. Shape and Dimensions

1) Dimensions: See the following.

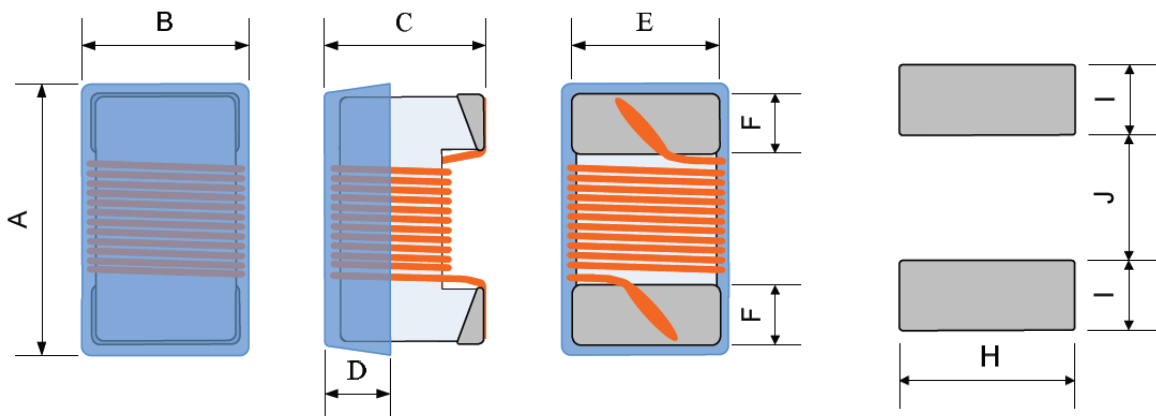

Unit: mm

A MAX.	B MAX.	C MAX.	D REF.	E REF.	F REF.	H REF.	I REF.	J REF.
1.8	1.12	1.02	0.38	0.76	0.33	1.02	0.64	0.64

- 2) Electrode Coplanarity: 0.1mm Max.
- 3) Structure: See the following.

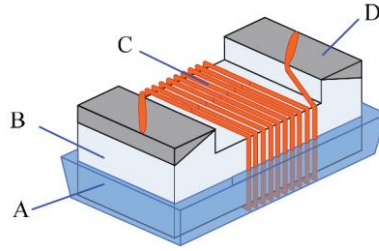

No.	Components	Material
A	Coating	Ultraviolet epoxy resin
B	Core	Ceramic
C	Wire	Polyurethane system enameled copper wire
D	Electrodes	Ag-Pd with Ni and Sn plating

5. Test and Measurement Procedures

5.1 Test Conditions

Unless otherwise specified, the standard atmospheric conditions for measurement/test are:

- a. Ambient Temperature: $20 \pm 15^\circ\text{C}$
- b. Relative Humidity: $65\% \pm 20\%$
- c. Air Pressure: 86 KPa to 106 KPa

If any doubt on the results, measurements/tests should be made within the following limits:

- a. Ambient Temperature: $20 \pm 2^\circ\text{C}$
- b. Relative Humidity: $65\% \pm 5\%$
- c. Air Pressure: 86KPa to 106 KPa

5.2 Visual Examination

- a. Inspection Equipment: 30X magnifier

5.3 Electrical Test

5.3.1 DC Resistance (DCR)

- a. Refer to Item 3.
- b. Test equipment: HIOKI3540 or equivalent.

5.3.2 Inductance (L)

- a. Refer to Item 3.
- b. Test equipment: Agilent4287A+Agilent16197A or equivalent.
- c. Test signal: -13dBm or 10mA
- d. Test frequency refers to Item 3.

5.3.3 Q Factor (Q)

- a. Refer to Item 3.
- b. Test equipment: Agilent4287A+Agilent16197A or equivalent.
- c. Test signal: -13dBm or 10mA
- d. Test frequency refers to Item 3.

5.3.4 Self-Resonant Frequency (SRF)

- a. Refer to Item 3.
- b. Test equipment: Agilent4991B+Agilent16197A and HP 8753E or equivalent.
- c. Test signal: -20dBm or 50mV

5.3.5 Rated Current

- a. Refer to Item 3.
- b. Test equipment (see Fig.5.3.5-1): Electric Power, Electric current meter, Thermometer.
- c. Measurement method (see Fig. 5.3.5-1):
 1. Set test current to be 0 mA.
 2. Measure initial temperature of chip surface.
 3. Gradually increase voltage and measure chip temperature for corresponding current.
- d. Definition of Rated Current (I_r): I_r is direct electric current as chip surface temperature rose just 15°C against chip initial surface temperature (T_a) (see Fig. 5.3.5-2).

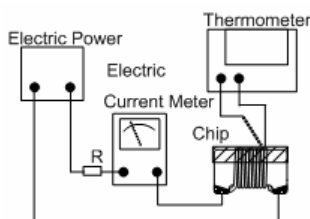

Fig. 5.3.5-1

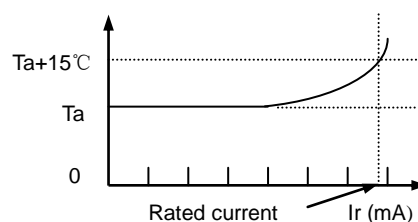
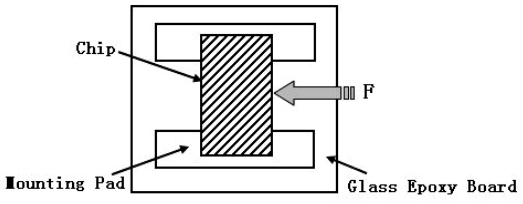
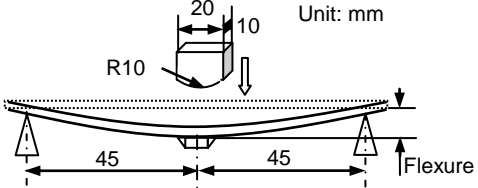
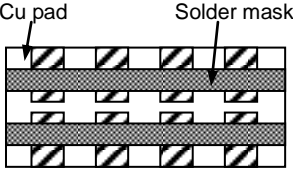
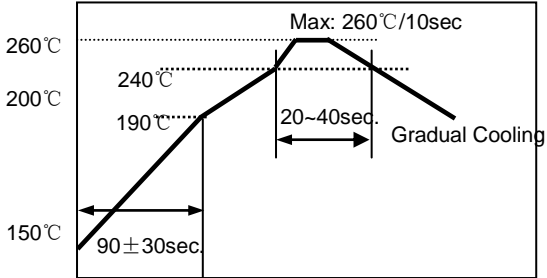
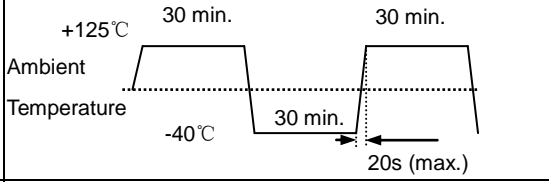

Fig. 5.3.5-2

5.4 Reliability Test

Items	Requirements	Test Methods and Remarks
5.4.1 Terminal Strength	No removal or split of the termination or other defects shall occur. 	① Solder the inductor to the testing jig (glass epoxy board) using eutectic solder. Then apply a force in the direction of the arrow. ② 7N force. ③ Keep time: 10±1s ④ Speed: 1.0 mm/s.
5.4.2 Resistance to Flexure	No visible mechanical damage. 	① Solder the inductor to the test jig. Using a eutectic solder. Then apply a force in the direction shown as left. ② Flexure: 2mm ③ Pressurizing Speed: 0.5mm/sec. ④ Keep time: 5sec.
5.4.3 Vibration	① No visible mechanical damage. ② Inductance change: within ±5% ③ Q factor change: within ±20% 	① Solder the inductor to the testing jig (glass epoxy board) using eutectic solder. ② The inductor shall be subjected to a simple harmonic motion having total amplitude of 1.5mm, the frequency being varied uniformly between the approximate limits of 10 and 55 Hz. ③ The frequency range from 10 to 55 Hz and return to 10 Hz shall be traversed in approximately 1 minute. This motion shall be applied for a period of 2 hours in each 3 mutually perpendicular directions (total of 6 hours)
5.4.4 Dropping	① No visible mechanical damage. ② Inductance change: within ±5% ③ Q factor change: within ±20%	Drop chip inductor 10 times on a concrete floor from a height of 100 cm.
5.4.5 Temperature coefficient	+50±100ppm/°C	① Between -40°C and +125°C ② With a reference value of +20°C
5.4.6 Solderability	90% or more of electrode area shall be Coated by new solder.	① Electrode of the coil shall be immersed in flux for 5 to 10 Seconds. ② The coil shall be immersed in solder bath at a temperature of 240±5°C, Duration for 3±0.5 seconds. ③ Solder: Sn/3.0Ag/0.5Cu ④ Flux: 25% Resin and 75% ethanol in weight.
5.4.7 Resistance to Soldering Heat	① No visible mechanical damage. ② Inductance change: within ±5% ③ Q factor change: within ±20%	Re-flowing Profile: 

<p>5.4.8 Thermal Shock</p>	<p>① No visible mechanical damage. ② Inductance change: within $\pm 5\%$ ③ Q factor change: within $\pm 20\%$</p> 	<p>① Temperature, Time: -40°C for 30±3 min → +125°C for 30±3 min ② Transforming interval: 20s (max.) ③ Tested cycle: 100 cycles ④ The chip shall be stabilized at normal condition for 1~2 hours before measuring.</p>
<p>5.4.9 Resistance to Low Temperature</p>	<p>① No visible mechanical damage. ② Inductance change: within $\pm 5\%$ ③ Q factor change: within $\pm 20\%$</p>	<p>① Temperature: $-40 \pm 2^\circ\text{C}$ ② Duration: 1000⁺²⁴ hours ③ The chip shall be stabilized at normal condition for 1~2 hours before measuring.</p>
<p>5.4.10 Resistance to High Temperature</p>	<p>① No mechanical damage. ② Inductance change: within $\pm 5\%$ ③ Q factor change: within $\pm 20\%$</p>	<p>① Temperature: $125 \pm 2^\circ\text{C}$ ② Duration: 1000⁺²⁴ hours ③ The chip shall be stabilized at normal condition for 1~2 hours before measuring.</p>
<p>5.4.11 Damp Heat (Steady States)</p>	<p>① No mechanical damage. ② Inductance change: within $\pm 5\%$ ③ Q factor change: within $\pm 20\%$</p>	<p>① Temperature: $60 \pm 2^\circ\text{C}$, Humidity: 90% to 95% RH ② Duration: 1000⁺²⁴ hours ③ The chip shall be stabilized at normal condition for 1~2 hours before measuring.</p>
<p>5.4.12 Loading Under Damp Heat</p>	<p>① No mechanical damage. ② Inductance change: within $\pm 5\%$ ③ Q factor change: within $\pm 20\%$</p>	<p>① Temperature: $60 \pm 2^\circ\text{C}$, Humidity: 90% to 95% RH ② Duration: 1000⁺²⁴ hours ③ Applied current: Rated current. ④ The chip shall be stabilized at normal condition for 1~2 hours before measuring.</p>
<p>5.4.13 Loading at High Temperature (Life Test)</p>	<p>① No mechanical damage. ② Inductance change: within $\pm 5\%$ ③ Q factor change: within $\pm 20\%$</p>	<p>① Temperature: $125 \pm 2^\circ\text{C}$ ② Duration: 1000⁺²⁴ hours ③ Applied current: Rated current. ④ The chip shall be stabilized at normal condition for 1~2 hours before measuring.</p>

6. Packaging and Storage

6.1 Packaging

There is one type of packaging for the chip inductors. Please specify the packing code when ordering.

Tape Carrier Packaging:

Packaging code: T

- i. Tape carrier packaging are specified in attached figure **Fig.6.1-1~5**
- ii. Tape carrier packaging quantity please see the following table:

Type	1608
Tape	Paper Tape
Quantity	3K

(1) Taping Drawings (Unit: mm)

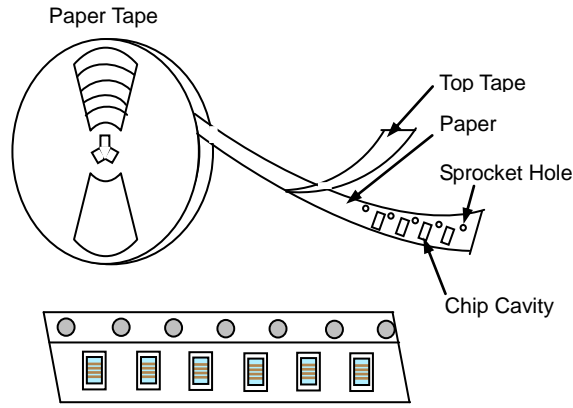

Fig. 6.1-1

Remark: The sprocket holes are to the right as the tape is pulled toward the user.

(2) Taping Dimensions (Unit: mm)

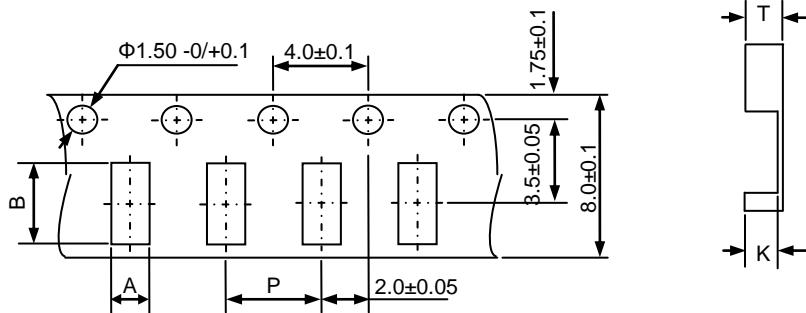

Fig. 6.1-2

Type	A	B	P	K	T
1608	1.17 ± 0.05	1.80 ± 0.05	4.0 ± 0.10	1.03 ± 0.10	1.07 ± 0.10

(3) Leader and blank portion

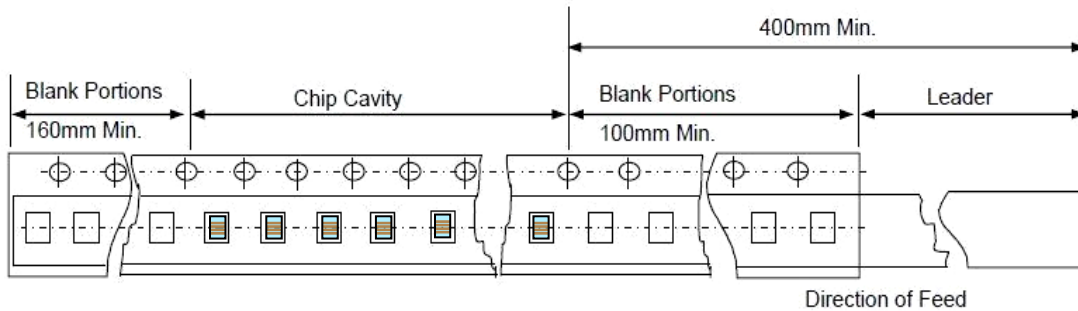

Fig. 6.1-3

(4) Reel Dimensions (Unit: mm)

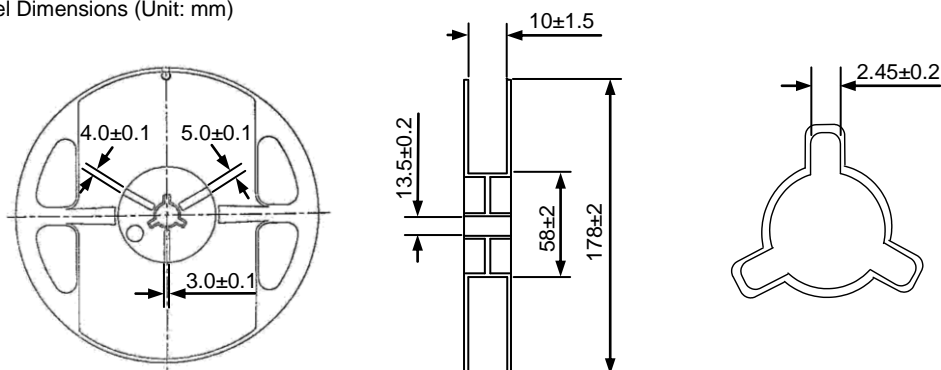
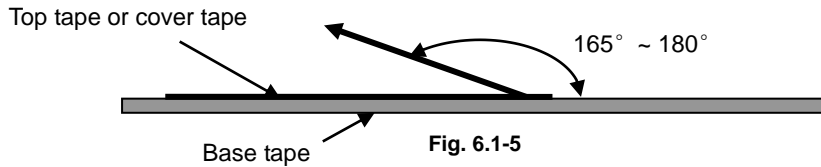

Fig. 6.1-4

(5) Peeling off force: 10gf to 70gf in the direction show below.



6.2 Storage

- a. The solderability of the external electrode may be deteriorated if packages are stored where they are exposed to high humidity. Package must be stored at 40°C or less and 70% RH or less.
- b. The solderability of the external electrode may be deteriorated if packages are stored where they are exposed to dust of harmful gas (e.g. HCl, sulfurous gas of H₂S)
- c. Packaging material may be deformed if package are stored where they are exposed to heat of direct sunlight.
- d. Minimum packages, such as polyvinyl heat-seal packages shall not be opened until they are used. If opened, use the reels as soon as possible.
- e. Solderability shall be guaranteed for 12 months from the date of delivery on condition that they are stored at the environment specified in specification. For those parts, which passed more than 12 months shall be checked solder-ability before use.

7. Warning and Attentions

7.1 Precautions on Use

- a. Always wear static control bands to protect against ESD.
- b. Any devices used (soldering iron, measuring instruments) should be properly grounded.
- c. Use non-magnetic tweezers when handing the chips.
- d. Pre-heating when soldering, and refer to the recommended condition specified in specification.
- e. Don't apply current in excess of the rated current value. It may cause damage to components due to over-current.
- f. Keep clear of anything that may generate magnetic fields such as speakers, coils.
- g. When soldering, the electrical characteristics may be varied due to hot energy and mechanical stress.
- h. When coating products with resin, the relatively high resin curing stress may change the electrical characteristics. For exterior coating, select resin carefully so that electrical and mechanical performance of the product is not affected. Before using, please evaluate reliability with the product mounted in your application set.
- i. When mount chips with adhesive in preliminary assembly, do appropriate check before the soldering stage, i.e., the size of land pattern, type of adhesive, amount applied, hardening of the adhesive on proper usage and amounts of adhesive to use.
- j. Mounting density: Add special attention to radiating heat of products when mounting other components nearby. The excessive heat by other products may cause deterioration at joint of this product with substrate.
- k. Since some products are constructed like an open magnetic circuit, narrow spacing between components may cause magnetic coupling.
- l. Please do not give the product any excessive mechanical shocks in transportation.
- m. Please do not touch wires by sharp terminals such as tweezers to avoid causing any damage to wires.
- n. Please do not add any shock and power to the soldered product to avoid causing any damage to chip body.
- o. Please do not touch the electrodes by naked hand as the solderability of the external electrodes may deteriorate by grease or oil on the skin.

7.2 PCB Bending Design

The following shall be considered when designing and laying out PCB's.

- a. PCB shall be designed so that products are not subjected to the mechanical stress from board warp or deflection.

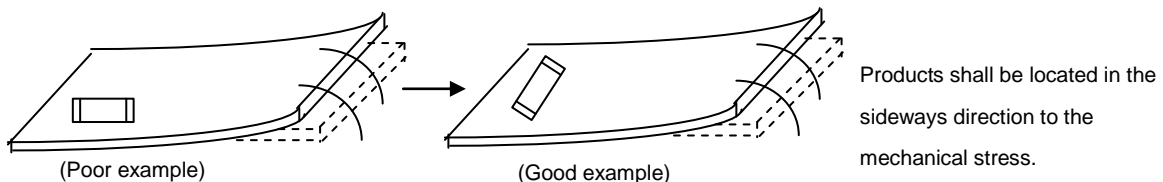

- b. Products location on PCB separation.

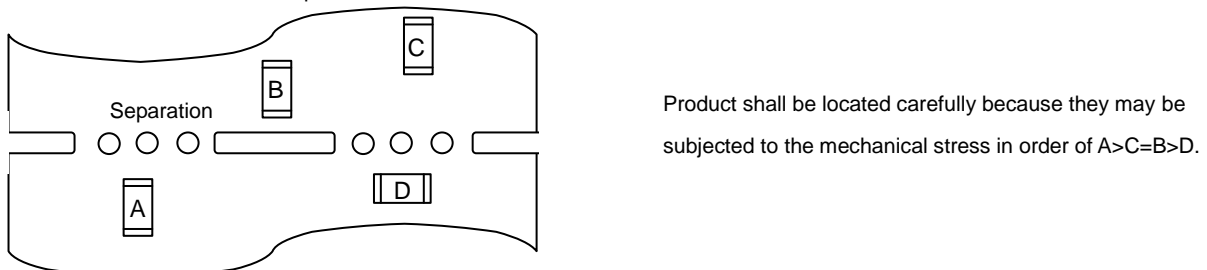

- c. When splitting the PCB board, or insert (remove) connector, or fasten thread after mounting components, care is required so as not to give any stress of deflection or twisting to the board. Because mechanical force may cause deterioration of the bonding strength of electrode and solder, even crack of product body. Board separation should not be done manually, but by using appropriate devices.

7.3 Recommended PCB Design for SMT Land-Patterns

When chips are mounted on a PCB, the amount of solder used (size of fillet) and the size of PCB Land-Patterns can directly affect chip performance (such as Q). And they can also cause other soldering question (such as offset and side lap). Therefore, the following items must be carefully considered in the design of solder land patterns.

- a. Please use the PCB pad and solder paste we recommend, and contact us in advance if they need to be changed.
- b. Please use flux contained with resin since the highly acidic (Chlorine content more than 0.2 wt%) or water-soluble one could damage the insulation film of wires, then causing short circuit of parts.
- c. The amount of solder applied can affect the ability of chips to withstand mechanical stresses which may lead to breaking or cracking. Therefore, when designing land-patterns it is necessary to consider the appropriate size and configuration of the solder pads which in turn determines the amount of solder necessary to form the fillets.
- d. When more than one part is jointly soldered onto the same land or pad, the pad must be designed that each component's soldering point is separated by solder-resist.

Recommended land dimensions please refer to product specification.

8. Recommended Soldering Technologies

This product is only for reflow soldering and iron soldering.

8.1 Re-flowing Profile

- △ Preheat condition: 150~200°C/60~120sec.
- △ Allowed time above 217°C: 60~90sec.
- △ Max temp: 260°C
- △ Max time at max temp: 10sec.
- △ Solder paste: Sn/3.0Ag/0.5Cu
- △ Allowed Reflow time: 2 times max.

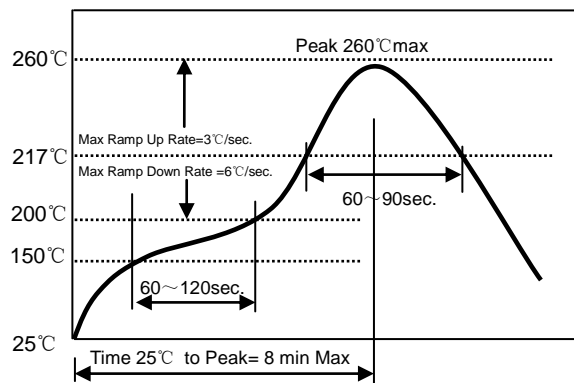

[Note: The reflow profile in the above table is only for qualification and is not meant to specify board assembly profiles. Actual board assembly profiles must be based on the customer's specific board design, solder paste and process, and should not exceed the parameters as the Reflow profile shows.]

8.2 Iron Soldering Profile

- △ Iron soldering power: 30W Max.
- △ Preheat condition: 150°C/60sec.
- △ Soldering tip temperature: 350°C Max.
- △ Soldering time: 3sec. Max.
- △ Solder paste: Sn/3.0Ag/0.5Cu
- △ Iron Soldering time: 1 time max.

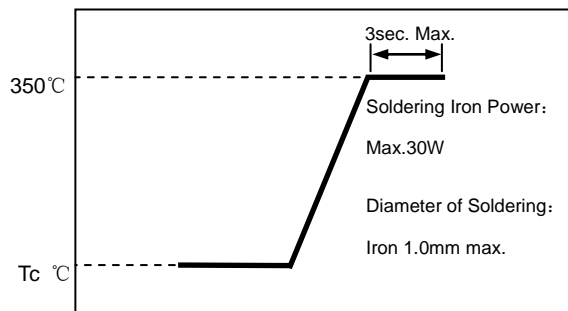

[Note: Take care not to apply the tip of the soldering iron to the terminal electrodes.]

8.3 Maintenance of heat gun (for your reference)

- △ Power output: 30W
- △ Temperature: 350°C Max
- △ Heat time: More than 5 seconds heating may cause short circuit of parts.

9. Solder Volume

Solder shall be used not to exceed as shown below.

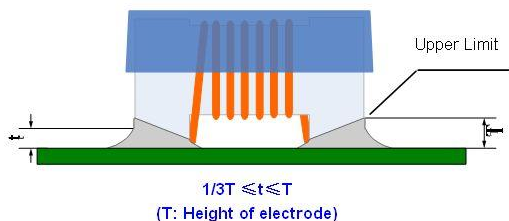

- a. Accordingly increasing the solder volume, the mechanical stress to chip is also increased. Exceeding solder volume may cause the failure of mechanical or electrical performance.
- b. Before soldering, please ensure that the solder should not adhere to the wire part of chip.
- c. Please pay particular attention to whether there is flux remaining on surface of the wire part of chip after subjected to reflow soldering since this may cause short circuit of parts.

10. Cleaning

Products shall be cleaned on the following conditions:

- a. Cleaning temperature shall be limited to 60°C Max. (40°C Max. for fluoride and alcohol type cleaner.)
- b. Ultrasonic cleaning shall comply with the following conditions, avoiding the resonance phenomenon at the mounted products and PCB.
 - Power: 20W/l Max.
 - Frequency: 28 KHz to 40 KHz
 - Time: 5 minutes Max
- c. Cleaner
 - i. Alternative cleaner
 - Isopropyl alcohol (IPA)
 - HCFC-225
 - ii. Aqueous agent
 - Surface Active Agent Type (Clean through-750H)
 - Hydrocarbon Type (Techno Cleaner-335)
 - Higher Alcohol Type (Pine Alpha ST-100S)
 - Alkali saponifier Type (※ Aqua Cleaner 240)
 - ※ Alkali saponification shall be diluted to 20% volume with de-ionized water.
 - ※ Please contact our technical service department before using other cleaner.
- d. There shall be no residual flux and residual cleaner after cleaning. In the case of using aqueous agent, product shall be dried completely after rinse with de-ionized water in order to remove the cleaner.
- e. Some products may become slightly whitened. However, product performance or usage is not affected.
- f. Please take care of winding part while cleaning.
- g. After cleaning, parts could be subjected to the next reflow soldering till the solvent remaining on surface of parts being volatilized.

Appendix A: Electrical Characteristics

I SDWL1608C□□□□STFN□□ Series

Part Number	Inductance	Tolerance	Min. Quality Factor	L/Q Test Freq.	Max. DC Resistance	Max. Rated Current	Min. Self-resonant Frequency
Units	nH	-	-	MHz	Ω	mA	MHz
Symbol	L	-	Q	Freq.	DCR	I _r	S.R.F
SDWL1608C1N6□STFN01	1.6	S	24	250	0.030	700	12500
SDWL1608C1N8□STFN01	1.8	J, K	16	250	0.045	700	12500
SDWL1608C2N2□STFN01	2.2	J, K	13	250	0.250	100	12500
SDWL1608C2N7□STFN01	2.7	J, K	25	250	0.043	1000	6000
SDWL1608C3N3□STFN01	3.3	J, K	35	250	0.045	700	5900
SDWL1608C3N6□STFN01	3.6	J, K	22	250	0.063	700	5900
SDWL1608C3N9□STFN01	3.9	J, K	22	250	0.080	700	6900
SDWL1608C4N3□STFN01	4.3	J, K	22	250	0.063	700	5900
SDWL1608C4N7□STFN01	4.7	J, K	20	250	0.116	700	5800
SDWL1608C5N1□STFN01	5.1	J, K	20	250	0.140	700	5700
SDWL1608C5N6□STFN01	5.6	J, K	26	250	0.075	700	4760
SDWL1608C6N8□STFN01	6.8	G, J	27	250	0.110	700	5800
SDWL1608C7N5□STFN01	7.5	G, J	28	250	0.106	700	4800
SDWL1608C8N2□STFN01	8.2	G, J	30	250	0.115	700	4200
SDWL1608C8N7□STFN01	8.7	G, J	28	250	0.109	700	4600
SDWL1608C9N5□STFN01	9.5	G, J	28	250	0.135	700	5400
SDWL1608C10N□STFN01	10	G, J	31	250	0.130	700	4800
SDWL1608C11N□STFN01	11	G, J	30	250	0.130	700	4000
SDWL1608C12N□STFN01	12	G, J	35	250	0.130	700	4000
SDWL1608C15N□STFN01	15	G, J	35	250	0.170	700	4000
SDWL1608C16N□STFN01	16	G, J	34	250	0.17	700	3300
SDWL1608C18N□STFN01	18	G, J	35	250	0.170	700	3100
SDWL1608C22N□STFN01	22	G, J	38	250	0.190	700	3000
SDWL1608C23N□STFN01	23	G, J	38	250	0.19	700	2850
SDWL1608C24N□STFN01	24	G, J	36	250	0.190	700	2650
SDWL1608C27N□STFN01	27	G, J	40	250	0.220	600	2800
SDWL1608C30N□STFN01	30	G, J	37	250	0.220	600	2250
SDWL1608C33N□STFN01	33	G, J	40	250	0.220	600	2300
SDWL1608C36N□STFN01	36	G, J	37	250	0.250	600	2080
SDWL1608C39N□STFN01	39	G, J	40	250	0.250	600	2200
SDWL1608C43N□STFN01	43	G, J	38	250	0.280	600	2000
SDWL1608C47N□STFN01	47	G, J	38	200	0.280	600	2000
SDWL1608C51N□STFN01	51	G, J	35	200	0.250	600	1900
SDWL1608C56N□STFN01	56	G, J	38	200	0.310	600	1900
SDWL1608C68N□STFN01	68	G, J	37	200	0.340	600	1700
SDWL1608C72N□STFN01	72	G, J	34	150	0.490	400	1700
SDWL1608C82N□STFN01	82	G, J	34	150	0.540	400	1700
SDWL1608CR10□STFN01	100	G, J	34	150	0.580	400	1400
SDWL1608CR11□STFN01	110	G, J	32	150	0.610	300	1350
SDWL1608CR12□STFN01	120	G, J	32	150	0.650	300	1300
SDWL1608CR15□STFN01	150	G, J	28	150	0.920	280	990

Part Number	Inductance	Tolerance	Min. Quality Factor	L/Q Test Freq.	Max. DC Resistance	Max. Rated Current	Min. Self-resonant Frequency
Units	nH	-	-	MHz	Ω	mA	MHz
Symbol	L	-	Q	Freq.	DCR	I _r	S.R.F
SDWL1608CR18□STFN01	180	G, J	25	100	1.250	240	990
SDWL1608CR20□STFN01	200	G, J	25	100	1.980	200	900
SDWL1608CR21□STFN01	210	G, J	27	100	2.060	200	895
SDWL1608CR22□STFN01	220	G, J	25	100	2.100	200	900
SDWL1608CR23□STFN01	230	G, J	25	100	2.120	190	875
SDWL1608CR25□STFN01	250	G, J	25	100	3.550	120	822
SDWL1608CR27□STFN01	270	G, J	26	100	2.160	170	830
SDWL1608CR33□STFN01	330	G, J	25	100	3.890	100	900
SDWL1608CR39□STFN01	390	G, J	25	100	4.350	100	780

II. Typical Electrical Characteristics

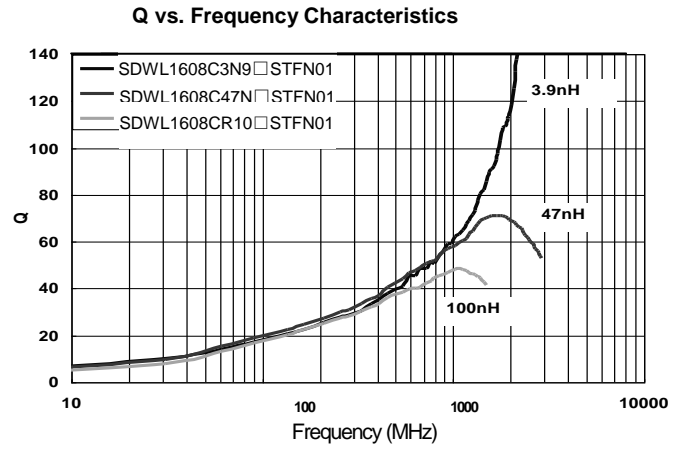
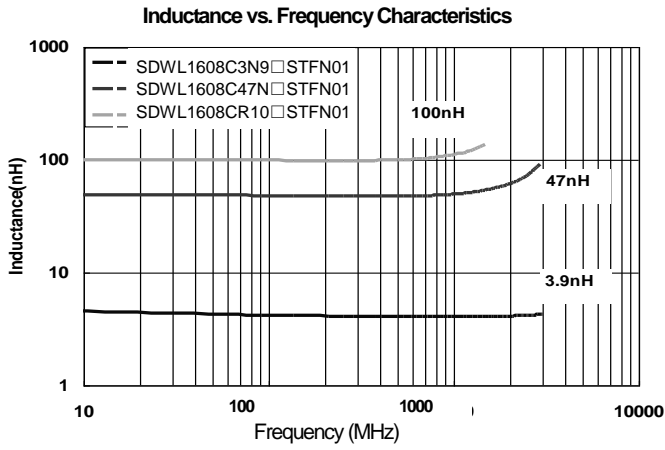

Appendix B: Appearance standard

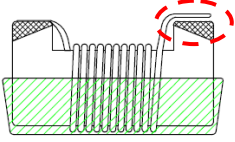
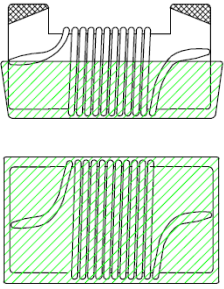
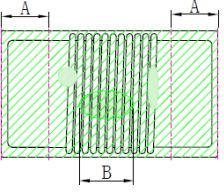
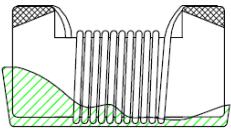
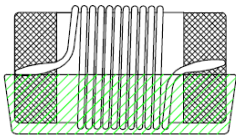
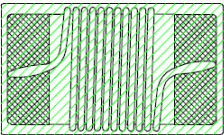
File No:		Applied to Wire Wound Ceramic Inductor Series	
Effective date:			
No.	Defect Item	Graphic Schematic Drawing	Rejection identification Criteria
1	Wire off/ Welding Spot Off		The solder joint Welding Spot of wire break away from electrodes, or over the electrodes.
2	Solder misplace		Solder joints are not at electrode side but at the coating side or flank.
3	Starvation		Coating side(Non-A region): if $B \geq 0.20\text{mm}$, NG. B : Resin starved diameter ; A: electrode region, A=0.48mm
			Flank: uncontrolled.
4	Coating misplace		Coating at flank
			Coating at electrodes side

X-ON Electronics

Largest Supplier of Electrical and Electronic Components

Click to view similar products for [Fixed Inductors](#) category:

Click to view products by [Sunlord](#) manufacturer:

Other Similar products are found below :

[CR32NP-151KC](#) [CR32NP-180KC](#) [CR32NP-181KC](#) [CR32NP-1R5MC](#) [CR32NP-390KC](#) [CR32NP-3R9MC](#) [CR32NP-680KC](#) [CR32NP-820KC](#) [CR32NP-8R2MC](#) [CR43NP-390KC](#) [CR43NP-560KC](#) [CR43NP-680KC](#) [CR54NP-181KC](#) [CR54NP-470LC](#) [CR54NP-820KC](#) [CR54NP-8R5MC](#) [70F224AI](#) [MGDQ4-00004-P](#) [MHL1ECTTP18NJ](#) [MHQ1005P10NJ](#) [MHQ1005P1N0S](#) [MHQ1005P2N4S](#) [MHQ1005P3N6S](#) [MHQ1005P5N1S](#) [MHQ1005P8N2J](#) [PE-51506NL](#) [PE-53601NL](#) [PE-53602NL](#) [PE-53630NL](#) [PE-53824SNLT](#) [PE-92100NL](#) [PG0434.801NLT](#) [PG0936.113NLT](#) [9220-20](#) [9310-16](#) [PM06-2N7](#) [PM06-39NJ](#) [A01TK](#) [1206CS-471XJ](#) [HC2LP-R47-R](#) [HC2-R47-R](#) [HC3-2R2-R](#) [HCF1305-3R3-R](#) [1206CS-151XG](#) [RCH664NP-140L](#) [RCH664NP-4R7M](#) [RCH8011NP-221L](#) [RCP1317NP-332L](#) [RCP1317NP-391L](#) [RCR1010NP-470M](#)