

# Wire Wound Chip Ceramic Inductor – SDWL-C Series

Operating Temp. : -40°C~+125°C

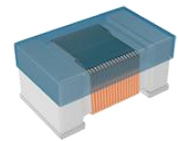

## FEATURES

- Small chip suitable for surface mounting
- High Q value and high self-resonant frequency with ceramic material
- Tight inductance tolerance and high reliability

## APPLICATIONS

- High frequency circuit in telecommunication and other equipments
- Mobile phones such as GSM, CDMA, TD-LTE, FDD-LTE, PDC, 5G NR, etc.
- Bluetooth, W-LAN, Broadband network

## PRODUCT IDENTIFICATION

<u>SDWL</u> ①	<u>1608</u> ②	<u>C</u> ③	<u>10N</u> ④	<u>J</u> ⑤	<u>S</u> ⑥	<u>T</u> ⑦	<u>F</u> ⑧																																																														
①	②	③	④	⑤	⑥	⑦	⑧																																																														
<table border="1"> <tr><th colspan="2">Type</th></tr> <tr><td>SDWL</td><td>Wire Wound Chip Inductor</td></tr> </table>	Type		SDWL	Wire Wound Chip Inductor	<table border="1"> <tr><th colspan="2">External Dimensions</th></tr> <tr><td>1608</td><td>[0603]</td></tr> <tr><td>2012</td><td>[0805]</td></tr> <tr><td>2520</td><td>[1008]</td></tr> <tr><td>3216</td><td>[1206]</td></tr> <tr><td>3225</td><td>[1210]</td></tr> <tr><td>4532</td><td>[1812]</td></tr> </table>	External Dimensions		1608	[0603]	2012	[0805]	2520	[1008]	3216	[1206]	3225	[1210]	4532	[1812]	<table border="1"> <tr><th colspan="2">号 Material Code</th></tr> <tr><td>C</td><td>陶瓷 Ceramic</td></tr> </table>	号 Material Code		C	陶瓷 Ceramic	<table border="1"> <tr><th colspan="2">Nominal Inductance</th></tr> <tr><th>Example</th><th>Nominal Value</th></tr> <tr><td>10N</td><td>10nH</td></tr> <tr><td>R10</td><td>100nH</td></tr> <tr><td>1R0</td><td>1.0μH</td></tr> </table>	Nominal Inductance		Example	Nominal Value	10N	10nH	R10	100nH	1R0	1.0μH	<table border="1"> <tr><th colspan="2">Inductance Tolerance</th></tr> <tr><td>B</td><td>±0.1nH</td></tr> <tr><td>C</td><td>±0.2nH</td></tr> <tr><td>S</td><td>±0.3nH</td></tr> <tr><td>D</td><td>±0.5nH</td></tr> <tr><td>G</td><td>±2%</td></tr> <tr><td>H</td><td>±3%</td></tr> <tr><td>J</td><td>±5%</td></tr> <tr><td>K</td><td>±10%</td></tr> </table>	Inductance Tolerance		B	±0.1nH	C	±0.2nH	S	±0.3nH	D	±0.5nH	G	±2%	H	±3%	J	±5%	K	±10%	<table border="1"> <tr><th colspan="2">Feature Type</th></tr> <tr><td>S</td><td>Sn Plating Five-faces Coating</td></tr> </table>	Feature Type		S	Sn Plating Five-faces Coating	<table border="1"> <tr><th colspan="2">Packing</th></tr> <tr><td>T</td><td>Tape &amp; Reel</td></tr> </table>	Packing		T	Tape & Reel	<table border="1"> <tr><th colspan="2">Hazardous Substance Free Products</th></tr> <tr><td colspan="2">F</td></tr> </table>	Hazardous Substance Free Products		F	
Type																																																																					
SDWL	Wire Wound Chip Inductor																																																																				
External Dimensions																																																																					
1608	[0603]																																																																				
2012	[0805]																																																																				
2520	[1008]																																																																				
3216	[1206]																																																																				
3225	[1210]																																																																				
4532	[1812]																																																																				
号 Material Code																																																																					
C	陶瓷 Ceramic																																																																				
Nominal Inductance																																																																					
Example	Nominal Value																																																																				
10N	10nH																																																																				
R10	100nH																																																																				
1R0	1.0μH																																																																				
Inductance Tolerance																																																																					
B	±0.1nH																																																																				
C	±0.2nH																																																																				
S	±0.3nH																																																																				
D	±0.5nH																																																																				
G	±2%																																																																				
H	±3%																																																																				
J	±5%																																																																				
K	±10%																																																																				
Feature Type																																																																					
S	Sn Plating Five-faces Coating																																																																				
Packing																																																																					
T	Tape & Reel																																																																				
Hazardous Substance Free Products																																																																					
F																																																																					

## SHAPE AND DIMENSIONS

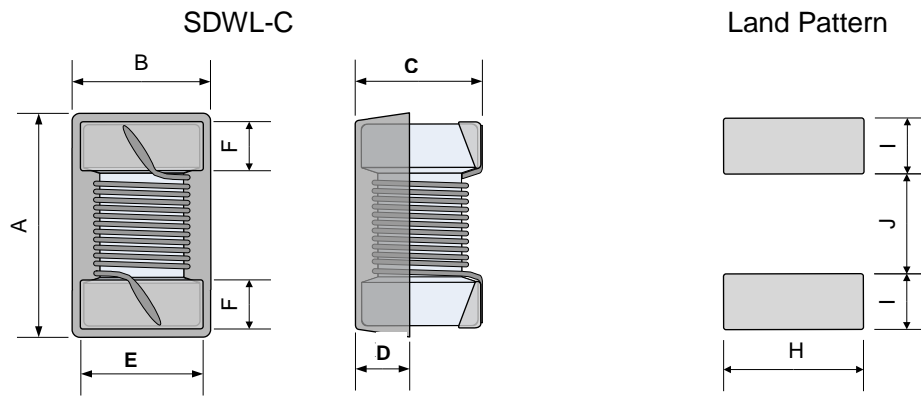

Unit: mm

Series	A Max.	B Max.	C Max.	D Typ.	E Typ.	F Typ.	H Typ.	I Typ.	J Typ.
SDWL1608C	1.80	1.12	1.02	0.38	0.80	0.30	1.02	0.64	0.64
SDWL2012C	2.29	1.73	1.55	0.51	1.27	0.50	1.78	1.02	0.76
SDWL2520C	2.92	2.79	2.29	0.51	2.10	0.50	2.54	1.02	1.27
SDWL3216C	3.56	2.16	1.52	0.51	1.60	0.50	1.93	1.02	1.78
SDWL3225C	3.65	2.95	2.70	0.51	2.10	0.50	3.02	1.02	1.78
SDWL4532C	4.95	3.81	3.43	1.78	2.90	0.58	3.05	1.14	3.00

## SPECIFICATIONS

### SDWL1608C-S TYPE

Part Number	Inductance	Tolerance	Min. Quality Factor	L/Q Test Freq.	Max. DC Resistance	Max. Rated Current	Min. Self-resonant Frequency
Units	nH	-	-	MHz	$\Omega$	mA	MHz
Symbol	L	-	Q	Freq.	DCR	I <sub>r</sub>	S.R.F
SDWL1608C1N6□STF	1.6	C,S,D,K	22	250	0.035	1150	>6000
SDWL1608C1N7□STF	1.7	C,S,D,J,K	16	250	0.043	1000	>6000
SDWL1608C1N8□STF	1.8	C,S,D,J,K	18	250	0.043	1000	>6000
SDWL1608C2N2□STF	2.2	S,D,K	13	250	0.150	700	>6000
SDWL1608C2N7□STF	2.7	C,S,D,J,K	25	250	0.043	1000	>6000
SDWL1608C3N3□STF	3.3	C,S,D,J,K	25	250	0.059	850	>6000
SDWL1608C3N6□STF	3.6	C,S,D,J,K	25	250	0.059	850	>6000
SDWL1608C3N9□STF	3.9	C,S,D,J,K	25	250	0.059	850	>6000
SDWL1608C4N3□STF	4.3	C,S,D,J,K	25	250	0.059	850	>6000
SDWL1608C4N7□STF	4.7	C,S,D,J,K	25	250	0.065	800	>6000
SDWL1608C5N1□STF	5.1	C,S,D,J,K	21	250	0.130	600	>6000
SDWL1608C6N2□STF	6.2	C,S,D,J,K	29	250	0.095	700	>6000
SDWL1608C6N8□STF	6.8	G,H,J,K	29	250	0.095	700	>6000
SDWL1608C7N5□STF	7.5	G,H,J,K	33	250	0.095	700	>6000
SDWL1608C8N2□STF	8.2	G,H,J,K	31	250	0.095	700	>6000
SDWL1608C8N7□STF	8.7	G,H,J,K	31	250	0.095	700	>6000
SDWL1608C9N1□STF	9.1	G,H,J,K	30	250	0.120	620	6000
SDWL1608C9N5□STF	9.5	G,H,J,K	26	250	0.160	540	6000
SDWL1608C10N□STF	10	G,H,J,K	30	250	0.130	600	6000
SDWL1608C11N□STF	11	G,H,J,K	35	250	0.130	600	6000
SDWL1608C12N□STF	12	G,H,J,K	35	250	0.130	600	6000
SDWL1608C13N□STF	13	G,H,J,K	35	250	0.130	600	6000
SDWL1608C15N□STF	15	G,H,J,K	37	250	0.150	550	6000
SDWL1608C16N□STF	16	G,H,J,K	37	250	0.150	550	5500
SDWL1608C17N□STF	17	G,H,J,K	37	250	0.150	550	5500

# SPECIFICATIONS

## SDWL1608C-S TYPE

Part Number	Inductance	Tolerance	Min. Quality Factor	L/Q Test Freq.	Max. DC Resistance	Max. Rated Current	Min. Self-resonant Frequency
Units	nH	-	-	MHz	$\Omega$	mA	MHz
Symbol	L	-	Q	Freq.	DCR	I <sub>r</sub>	S.R.F
SDWL1608C18N□STF	18	G,H,J,K	37	250	0.150	550	5500
SDWL1608C20N□STF	20	G,H,J,K	37	250	0.150	550	4900
SDWL1608C22N□STF	22	G,H,J,K	38	250	0.190	490	4600
SDWL1608C23N□STF	23	G,H,J,K	40	250	0.190	490	3800
SDWL1608C24N□STF	24	G,H,J,K	40	250	0.190	490	3800
SDWL1608C25N□STF	25	G,H,J,K	40	250	0.190	490	3700
SDWL1608C27N□STF	27	G,H,J,K	38	250	0.190	490	3700
SDWL1608C30N□STF	30	G,H,J,K	38	250	0.210	470	3300
SDWL1608C33N□STF	33	G,H,J,K	40	250	0.210	470	3200
SDWL1608C36N□STF	36	G,H,J,K	40	250	0.220	460	2900
SDWL1608C39N□STF	39	G,H,J,K	40	250	0.220	460	2800
SDWL1608C43N□STF	43	G,H,J,K	40	250	0.270	400	2700
SDWL1608C47N□STF	47	G,H,J,K	36	200	0.270	400	2600
SDWL1608C51N□STF	51	G,H,J,K	35	200	0.300	390	2400
SDWL1608C56N□STF	56	G,H,J,K	38	200	0.350	360	2400
SDWL1608C62N□STF	62	G,H,J,K	36	200	0.380	350	2300
SDWL1608C68N□STF	68	G,H,J,K	36	200	0.380	350	2200
SDWL1608C72N□STF	72	G,H,J,K	34	150	0.430	320	2100
SDWL1608C82N□STF	82	G,H,J,K	34	150	0.500	300	2000
SDWL1608C90N□STF	90	G,H,J,K	34	150	0.520	300	1900
SDWL1608C91N□STF	91	G,H,J,K	34	150	0.520	300	1900
SDWL1608CR10□STF	100	G,H,J,K	31	150	0.660	260	1800
SDWL1608CR11□STF	110	G,H,J,K	32	150	0.730	250	1700
SDWL1608CR12□STF	120	G,H,J,K	32	150	0.750	240	1600
SDWL1608CR13□STF	130	G,H,J,K	32	150	0.750	240	1500
SDWL1608CR14□STF	140	G,H,J,K	32	150	1.100	200	1400
SDWL1608CR15□STF	150	G,H,J,K	32	150	1.120	200	1400
SDWL1608CR16□STF	160	G,H,J,K	32	150	1.120	200	1400
SDWL1608CR18□STF	180	G,H,J,K	25	100	1.380	180	1300
SDWL1608CR20□STF	200	G,H,J,K	25	100	1.900	150	1250
SDWL1608CR21□STF	210	G,H,J,K	25	100	1.900	150	1250
SDWL1608CR22□STF	220	G,H,J,K	25	100	2.100	140	1200
SDWL1608CR24□STF	240	G,H,J,K	25	100	2.750	120	1100
SDWL1608CR25□STF	250	G,H,J,K	25	100	2.800	120	1100
SDWL1608CR27□STF	270	G,H,J,K	26	100	3.000	120	960
SDWL1608CR30□STF	300	G,H,J,K	26	100	4.050	110	900
SDWL1608CR33□STF	330	G,H,J,K	26	100	4.200	100	800
SDWL1608CR39□STF	390	G,H,J,K	27	100	4.500	100	800
SDWL1608CR42□STF	420	G,H,J,K	27	100	5.400	90	800
SDWL1608CR47□STF	470	G,H,J,K	27	100	5.700	90	700
SDWL1608CR56□STF	560	G,H,J,K	27	100	8.100	70	650

# SPECIFICATIONS

## SDWL2012C TYPE

Part Number	Inductance	Tolerance	Min. Quality Factor	L/Q Test Freq.	Max. DC Resistanc	Max. Rated Current	Min. Self-resonant Frequency
Units	nH	-	-	MHz	$\Omega$	mA	MHz
Symbol	L	-	Q	Freq.	DCR	I <sub>r</sub>	S.R.F
SDWL2012C2N2□STF	2.2	J,K	40	250/1500	0.10	600	>6000
SDWL2012C2N5□STF	2.5	J,K	25	100/250	0.05	600	>6000
SDWL2012C2N7□STF	2.7	J,K	40	250/1500	0.05	600	>6000
SDWL2012C2N8□STF	2.8	J,K	35	250/250	0.06	600	6000
SDWL2012C3N0□STF	3.0	J,K	25	250/1500	0.20	600	6000
SDWL2012C3N3□STF	3.3	J,K	25	250/1500	0.20	600	>6000
SDWL2012C3N6□STF	3.6	J,K	25	250/1500	0.2	400	6000
SDWL2012C3N9□STF	3.9	J,K	30	250/1500	0.2	400	6000
SDWL2012C4N7□STF	4.7	J,K	60	250/1500	0.04	600	>6000
SDWL2012C5N0□STF	5.0	J,K	40	250/250	0.1	600	5500
SDWL2012C5N1□STF	5.1	J,K	35	250/1000	0.1	600	5500
SDWL2012C5N6□STF	5.6	J,K	43	250/1000	0.1	600	5500
SDWL2012C6N0□STF	6.0	J,K	48	250/1000	0.11	600	5000
SDWL2012C6N2□STF	6.2	J,K	50	250/1000	0.05	600	5000
SDWL2012C6N8□STF	6.8	J,K	40	250/1000	0.11	600	5000
SDWL2012C7N5□STF	7.5	J,K	40	250/1000	0.14	600	4600
SDWL2012C8N2□STF	8.2	J,K	40	250/1000	0.19	600	4600
SDWL2012C8N5□STF	8.5	J,K	38	250/1000	0.27	600	5000
SDWL2012C9N1□STF	9.1	J,K	38	250/1000	0.16	600	5000
SDWL2012C10N□STF	10	G,J,K	44	250/1000	0.14	600	4500
SDWL2012C11N□STF	11	G,J,K	40	250/500	0.15	600	4000
SDWL2012C12N□STF	12	G,J,K	40	250/500	0.15	600	4000
SDWL2012C13N□STF	13	G,J,K	40	250/5000	0.17	600	3500
SDWL2012C14N□STF	14	G,J,K	40	250/5000	0.17	600	3400
SDWL2012C15N□STF	15	G,J,K	40	250/500	0.17	600	2900
SDWL2012C16N□STF	16	G,J,K	50	250/500	0.20	600	3300
SDWL2012C18N□STF	18	G,J,K	50	250/500	0.20	600	3300
SDWL2012C20N□STF	20	G,J,K	35	200/200	0.17	500	3000
SDWL2012C22N□STF	22	G,J,K	55	250/500	0.22	500	2000
SDWL2012C23N□STF	23	G,J,K	55	250/500	0.22	500	2000
SDWL2012C24N□STF	24	G,J,K	50	250/500	0.22	500	2000
SDWL2012C25N□STF	25	G,J,K	40	250/250	0.55	500	2000
SDWL2012C26N□STF	26	G,J,K	60	50/1500	0.1	500	2500
SDWL2012C26N8□STF	26.8	G,J,K	35	300/2500	0.25	500	2500
SDWL2012C27N□STF	27	G,J,K	55	250/500	0.25	500	2500
SDWL2012C28N□STF	28	G,J,K	50	250/500	0.25	500	2500
SDWL2012C29N□STF	29	G,J,K	45	250/500	0.25	500	1800
SDWL2012C30N□STF	30	G,J,K	50	250/500	0.27	500	2100
SDWL2012C31N□STF	31	G,J,K	50	250/500	0.27	500	2000
SDWL2012C33N□STF	33	G,J,K	60	250/500	0.27	500	2000
SDWL2012C36N□STF	36	G,J,K	55	250/500	0.27	500	1700
SDWL2012C39N□STF	39	G,J,K	60	250/500	0.29	500	2000
SDWL2012C43N□STF	43	G,J,K	50	200/500	0.34	500	1600
SDWL2012C45N□STF	45	G,J,K	50	200/500	0.31	500	1600
SDWL2012C47N□STF	47	G,J,K	50	200/500	0.31	500	1600
SDWL2012C51N□STF	51	G,J,K	45	200/500	0.38	500	1600
SDWL2012C55N□STF	55	G,J,K	55	200/500	0.32	500	1550
SDWL2012C56N□STF	56	G,J,K	55	200/500	0.32	500	1550

# SPECIFICATIONS

## SDWL2012C TYPE

Part Number	Inductance	Tolerance	Min. Quality Factor	L/Q Test Freq.	Max. DC Resistance	Max. Rated Current	Min. Self-resonant Frequency
Units	nH	-	-	MHz	$\Omega$	mA	MHz
Symbol	L	-	Q	Freq.	DCR	I <sub>r</sub>	S.R.F
SDWL2012C62N□STF	62	G,J,K	50	200/500	0.35	500	1400
SDWL2012C66N□STF	66	G,J,K	45	200/500	0.4	500	1200
SDWL2012C68N□STF	68	G,J,K	55	200/500	0.38	500	1450
SDWL2012C70N□STF	70	G,J,K	60	200/500	0.38	500	1400
SDWL2012C72N□STF	72	G,J,K	50	200/500	0.30	400	1400
SDWL2012C75N□STF	75	G,J,K	50	150/500	0.40	400	1400
SDWL2012C78N□STF	78	G,J,K	60	150/500	0.42	400	1400
SDWL2012C82N□STF	82	G,J,K	50	150/500	0.42	400	1300
SDWL2012C85N□STF	85	G,J,K	40	150/150	0.42	400	1020
SDWL2012C89N□STF	89	G,J,K	60	150/500	0.4	400	1300
SDWL2012C91N□STF	91	G,J,K	65	150/500	0.48	400	1200
SDWL2012C92N□STF	92	G,J,K	45	150/500	0.42	350	1300
SDWL2012CR10□STF	100	G,J,K	50	150/500	0.46	400	1200
SDWL2012CR11□STF	110	G,J,K	50	150/250	0.48	400	1100
SDWL2012CR12□STF	120	G,J,K	50	150/250	0.51	400	1100
SDWL2012CR13□STF	130	G,J,K	55	150/250	0.5	400	1200
SDWL2012CR14□STF	140	G,J,K	50	100/250	0.56	400	1100
SDWL2012CR144□STF	144	G,J,K	50	100/250	0.52	400	1000
SDWL2012CR15□STF	150	G,J,K	50	100/250	0.56	400	920
SDWL2012CR16□STF	160	G,J,K	45	100/250	0.8	400	900
SDWL2012CR18□STF	180	G,J,K	50	100/250	0.64	400	870
SDWL2012CR20□STF	200	G,J,K	45	100/250	0.64	400	900
SDWL2012CR22□STF	220	G,J,K	45	100/250	1.10	400	850
SDWL2012CR23□STF	230	G,J,K	40	100/250	1.20	400	770
SDWL2012CR24□STF	240	G,J,K	40	100/250	1.20	400	770
SDWL2012CR27□STF	270	G,J,K	38	100/250	1.00	350	650
SDWL2012CR28□STF	280	G,J,K	38	100/100	1.20	150	750
SDWL2012CR29□STF	290	G,J,K	38	100/100	1.20	150	750
SDWL2012CR30□STF	300	G,J,K	40	100/250	1.50	310	750
SDWL2012CR33□STF	330	G,J,K	40	100/250	1.40	310	600
SDWL2012CR35□STF	350	G,J,K	35	100/250	1.40	300	500
SDWL2012CR36□STF	360	G,J,K	35	100/250	1.50	290	560
SDWL2012CR39□STF	390	G,J,K	35	100/250	1.50	290	560
SDWL2012CR41□STF	410	G,J,K	35	100/250	1.50	290	560
SDWL2012CR43□STF	430	G,J,K	28	100/100	1.20	230	430
SDWL2012CR47□STF	470	G,J,K	33	50/100	1.72	250	375
SDWL2012CR49□STF	490	G,J,K	33	100/100	1.80	230	330
SDWL2012CR50□STF	500	G,J,K	23	25/50	1.80	230	330
SDWL2012CR51□STF	510	G,J,K	20	25/50	1.50	230	300
SDWL2012CR54□STF	540	G,J,K	23	25/50	1.90	230	300
SDWL2012CR56□STF	560	G,J,K	23	25/50	1.90	230	320
SDWL2012CR62□STF	620	G,J,K	23	25/50	1.95	200	280
SDWL2012CR65□STF	650	G,J,K	23	25/50	2.00	200	270
SDWL2012CR68□STF	680	G,J,K	23	25/50	2.05	190	270
SDWL2012CR72□STF	720	G,J,K	22	25/50	2.10	180	240
SDWL2012CR75□STF	750	G,J,K	23	25/50	2.10	180	240
SDWL2012CR82□STF	820	G,J,K	23	25/50	2.30	180	250

## SPECIFICATIONS

### SDWL2012C TYPE

Part Number	Inductance	Tolerance	Min. Quality Factor	L/Q Test Freq.	Max. DC Resistance	Max. Rated Current	Min. Self-resonant Frequency
Units	nH	-	-	MHz	$\Omega$	mA	MHz
Symbol	L	-	Q	Freq.	DCR	I <sub>r</sub>	S.R.F
SDWL2012CR86□STF	860	G,J,K	22	25/50	2.30	160	230
SDWL2012CR91□STF	910	G,J,K	22	25/50	2.40	160	230
SDWL2012C1R0□STF	1000	G,J,K	20	25/50	2.50	150	200
SDWL2012C1R2□STF	1200	G,J,K	18	25/50	3.50	100	200
SDWL2012C1R5□STF	1500	G,J,K	15	25/50	2.90	100	130
SDWL2012C1R8□STF	1800	G,J,K	15	7.9/25	3.50	120	120
SDWL2012C2R0□STF	2000	G,J,K	15	7.9/25	4.3	100	80
SDWL2012C2R2□STF	2200	G,J,K	16	7.9/25	4.60	100	70
SDWL2012C2R7□STF	2700	G,J,K	15	7.9/7.9	5.00	80	120
SDWL2012C3R3□STF	3300	G,J,K	10	7.9/7.9	5.40	50	80
SDWL2012C3R9□STF	3900	G,J,K	10	7.9/7.9	5.40	40	80
SDWL2012C4R7□STF	4700	G,J,K	18	7.9/25	8.20	30	70

### SDWL2520C TYPE

Part Number	Inductance	Tolerance	Min. Quality Factor	L/Q Test Freq.	Max. DC Resistance	Max. Rated Current	Min. Self-resonant Frequency
Units	nH	-	-	MHz	$\Omega$	mA	MHz
Symbol	L	-	Q	Freq.	DCR	I <sub>r</sub>	S.R.F
SDWL2520C3N6□STF	3.6	J,K	50	50/1500	0.05	1000	>6000
SDWL2520C3N9□STF	3.9	J,K	50	50/1500	0.10	1000	>6000
SDWL2520C4N1□STF	4.1	J,K	75	50/1500	0.05	1000	>6000
SDWL2520C4N7□STF	4.7	J,K	50	50/1500	0.11	1000	>6000
SDWL2520C5N6□STF	5.6	J,K	55	50/1500	0.14	1000	>6000
SDWL2520C6N8□STF	6.8	J,K	45	250/250	0.08	1000	>6000
SDWL2520C8N2□STF	8.2	J,K	60	50/1500	0.05	1000	5500
SDWL2520C10N□STF	10	G,J,K	50	50/500	0.08	1000	4100
SDWL2520C12N□STF	12	G,J,K	50	50/500	0.09	1000	3300
SDWL2520C15N□STF	15	G,J,K	50	50/500	0.13	1000	2500
SDWL2520C16N□STF	16	G,J,K	35	50/350	0.2	1000	2500
SDWL2520C18N□STF	18	G,J,K	50	50/350	0.11	1000	2500
SDWL2520C20N□STF	20	G,J,K	50	50/350	0.12	900	2400
SDWL2520C22N□STF	22	G,J,K	55	50/350	0.12	1000	2400
SDWL2520C24N□STF	24	G,J,K	55	50/350	0.13	1000	1600
SDWL2520C27N□STF	27	G,J,K	55	50/350	0.13	1000	1600
SDWL2520C28N□STF	28	G,J,K	70	50/350	0.095	1000	1800
SDWL2520C30N□STF	30	G,J,K	45	50/350	0.20	1000	1700
SDWL2520C33N□STF	33	G,J,K	60	50/350	0.14	1000	1600
SDWL2520C36N□STF	36	G,J,K	60	50/350	0.14	1000	1600
SDWL2520C39N□STF	39	G,J,K	50	50/350	0.15	1000	1500
SDWL2520C43N□STF	43	G,J,K	65	50/350	0.16	1000	1600
SDWL2520C44N□STF	44	G,J,K	60	50/350	0.15	1000	1500
SDWL2520C47N□STF	47	G,J,K	65	50/350	0.16	1000	1500
SDWL2520C48N□STF	48	G,J,K	60	50/350	0.16	1000	1400
SDWL2520C51N□STF	51	G,J,K	65	50/350	0.2	1000	1150
SDWL2520C52N□STF	52	G,J,K	65	50/350	0.2	1000	1150
SDWL2520C56N□STF	56	G,J,K	50	50/350	0.18	1000	1300
SDWL2520C60N□STF	60	G,J,K	50	50/350	0.21	1000	1200

# SPECIFICATIONS

## SDWL2520C TYPE

Part Number	Inductance	Tolerance	Min. Quality Factor	L/Q Test Freq.	Max. DC Resistance	Max. Rated Current	Min. Self-resonant Frequency
Units	nH	-	-	MHz	$\Omega$	mA	MHz
Symbol	L	-	Q	Freq.	DCR	I <sub>r</sub>	S.R.F
SDWL2520C62N□STF	62	G,J,K	50	50/350	0.21	1000	1200
SDWL2520C64N□STF	64	G,J,K	65	50/350	0.19	1000	1200
SDWL2520C65N□STF	65	G,J,K	50	50/350	0.12	1000	1200
SDWL2520C66N□STF	66	G,J,K	60	50/350	0.19	800	1200
SDWL2520C68N□STF	68	G,J,K	65	50/350	0.21	1000	1200
SDWL2520C72N□STF	72	G,J,K	50	50/350	0.22	900	1200
SDWL2520C75N□STF	75	G,J,K	50	50/350	0.22	900	1200
SDWL2520C80N□STF	80	G,J,K	60	50/350	0.22	1000	1000
SDWL2520C82N□STF	82	G,J,K	60	50/350	0.22	1000	800
SDWL2520C91N□STF	91	G,J,K	55	50/350	0.3	800	800
SDWL2520CR10□STF	100	G,J,K	60	25/350	0.56	650	1000
SDWL2520CR11□STF	110	G,J,K	35	100/100	0.85	650	950
SDWL2520CR12□STF	120	G,J,K	60	25/350	0.63	650	950
SDWL2520CR13□STF	130	G,J,K	70	25/350	0.045	650	950
SDWL2520CR15□STF	150	G,J,K	50	25/100	0.62	580	800
SDWL2520CR17□STF	170	G,J,K	45	25/100	0.77	500	650
SDWL2520CR18□STF	180	G,J,K	50	25/100	0.70	620	750
SDWL2520CR20□STF	200	G,J,K	45	25/100	0.15	450	700
SDWL2520CR22□STF	220	G,J,K	50	25/100	0.80	500	630
SDWL2520CR23□STF	230	G,J,K	50	25/100	0.85	500	600
SDWL2520CR24□STF	240	G,J,K	50	25/100	0.9	500	550
SDWL2520CR26□STF	260	G,J,K	50	25/100	0.91	500	600
SDWL2520CR27□STF	270	G,J,K	50	25/100	0.91	500	600
SDWL2520CR29□STF	290	G,J,K	45	25/100	1.0	500	550
SDWL2520CR30□STF	300	G,J,K	45	25/100	1.0	500	450
SDWL2520CR33□STF	330	G,J,K	50	25/100	1.05	450	530
SDWL2520CR35□STF	350	G,J,K	50	25/100	1.06	470	500
SDWL2520CR36□STF	360	G,J,K	50	25/100	1.06	470	500
SDWL2520CR39□STF	390	G,J,K	50	25/100	1.12	470	480
SDWL2520CR40□STF	400	G,J,K	50	25/100	1.12	470	480
SDWL2520CR43□STF	430	G,J,K	50	25/100	1.15	450	480
SDWL2520CR47□STF	470	G,J,K	50	25/100	1.19	470	450
SDWL2520CR50□STF	500	G,J,K	30	25/25	0.90	200	400
SDWL2520CR51□STF	510	G,J,K	50	25/100	1.25	420	380
SDWL2520CR52□STF	520	G,J,K	50	25/100	1.25	420	380
SDWL2520CR53□STF	530	G,J,K	50	25/100	1.25	420	380
SDWL2520CR54□STF	540	G,J,K	45	25/100	1.3	400	435
SDWL2520CR56□STF	560	G,J,K	50	25/100	1.33	400	390
SDWL2520CR62□STF	620	G,J,K	45	25/100	1.40	300	375
SDWL2520CR64□STF	640	G,J,K	45	25/100	1.47	300	375
SDWL2520CR68□STF	680	G,J,K	45	25/100	1.47	400	360
SDWL2520CR72□STF	720	G,J,K	45	25/100	1.47	360	370
SDWL2520CR75□STF	750	G,J,K	45	25/100	1.54	360	360
SDWL2520CR77□STF	770	G,J,K	45	25/100	1.54	360	350
SDWL2520CR82□STF	820	G,J,K	45	25/100	1.61	400	330
SDWL2520CR86□STF	860	G,J,K	40	25/100	1.61	380	330
SDWL2520CR91□STF	910	G,J,K	35	25/50	1.68	380	295
SDWL2520C1R0□STF	1000	G,J,K	35	25/50	1.80	370	270
SDWL2520C1R2□STF	1200	G,J,K	35	7.9/50	2.0	310	200
SDWL2520C1R5□STF	1500	G,J,K	28	7.9/50	2.3	330	150

## SPECIFICATIONS

### SDWL2520C TYPE

Part Number	Inductance	Tolerance	Min. Quality Factor	L/Q Test Freq.	Max. DC Resistance	Max. Rated Current	Min. Self-resonant Frequency
Units	nH	-	-	MHz	$\Omega$	mA	MHz
Symbol	L	-	Q	Freq.	DCR	I <sub>r</sub>	S.R.F
SDWL2520C1R8□STF	1800	G,J,K	28	7.9/50	2.6	300	120
SDWL2520C2R0□STF	2000	G,J,K	22	7.9/25	2.8	280	100
SDWL2520C2R2□STF	2200	G,J,K	22	7.9/25	2.8	280	100
SDWL2520C2R7□STF	2700	G,J,K	22	7.9/25	3.2	290	90
SDWL2520C3R0□STF	3000	G,J,K	20	7.9/25	3.2	290	50
SDWL2520C3R3□STF	3300	G,J,K	22	7.9/25	3.4	290	70
SDWL2520C3R6□STF	3600	G,J,K	20	7.9/25	3.8	250	60
SDWL2520C3R9□STF	3900	G,J,K	17	7.9/25	3.6	260	60
SDWL2520C4R3□STF	4300	G,J,K	13	7.9/25	3.9	260	30
SDWL2520C4R7□STF	4700	G,J,K	20	7.9/25	4.0	260	50
SDWL2520C5R1□STF	5100	G,J,K	20	7.9/25	6.2	200	40
SDWL2520C5R6□STF	5600	G,J,K	20	7.9/25	5.7	240	40
SDWL2520C6R8□STF	6800	G,J,K	20	7.9/25	7.7	200	40
SDWL2520C7R5□STF	7500	G,J,K	20	7.9/25	10	180	50
SDWL2520C8R2□STF	8200	G,J,K	20	7.9/7.9	10.7	150	30
SDWL2520C9R1□STF	9100	G,J,K	18	7.9/25	12	80	40
SDWL2520C100□STF	10000	G,J,K	20	7.9/7.9	8.5	100	40
SDWL2520C180□STF	18000	G,J,K	15	7.9/7.9	13	80	10
SDWL2520C220□STF	22000	G,J,K	20	7.9/7.9	18	70	20

### SDWL3216C TYPE

Part Number	Inductance	Tolerance	Min. Quality Factor	L/Q Test Freq.	Max. DC Resistance	Max. Rated Current	Min. Self-resonant Frequency
Units	nH	-	-	MHz	$\Omega$	mA	MHz
Symbol	L	-	Q	Freq.	DCR	I <sub>r</sub>	S.R.F
SDWL3216C3N3□STF	3.3	J,K	20	100/300	0.07	1000	6200
SDWL3216C5N6□STF	5.6	J,K	30	100/300	0.07	1000	5500
SDWL3216C6N8□STF	6.8	J,K	30	100/300	0.07	1000	5500
SDWL3216C8N2□STF	8.2	J,K	30	100/300	0.07	1000	5500
SDWL3216C10N□STF	10	G,J,K	40	100/300	0.09	1000	4000
SDWL3216C12N□STF	12	G,J,K	40	100/300	0.09	1000	3200
SDWL3216C15N□STF	15	G,J,K	40	100/300	0.12	1000	3200
SDWL3216C18N□STF	18	G,J,K	45	100/300	0.12	1000	2800
SDWL3216C22N□STF	22	G,J,K	50	100/300	0.12	1000	2200
SDWL3216C27N□STF	27	G,J,K	50	100/300	0.12	1000	1800
SDWL3216C30N□STF	30	G,J,K	50	100/300	0.12	1000	1800
SDWL3216C33N□STF	33	G,J,K	50	100/300	0.12	1000	1800
SDWL3216C39N□STF	39	G,J,K	50	100/300	0.12	1000	1800
SDWL3216C47N□STF	47	G,J,K	50	100/300	0.13	1000	1500
SDWL3216C56N□STF	56	G,J,K	55	100/300	0.14	1000	1450
SDWL3216C68N□STF	68	G,J,K	55	100/300	0.26	900	1200
SDWL3216C82N□STF	82	G,J,K	55	100/300	0.21	900	1200
SDWL3216CR10□STF	100	G,J,K	55	100/300	0.30	850	1100
SDWL3216CR12□STF	120	G,J,K	60	100/300	0.30	800	1100
SDWL3216CR15□STF	150	G,J,K	55	100/300	0.31	750	950
SDWL3216CR18□STF	180	G,J,K	60	50/300	0.43	700	900
SDWL3216CR22□STF	220	G,J,K	60	50/300	0.56	670	760



## SPECIFICATIONS

### SDWL3216C TYPE

Part Number	Inductance	Tolerance	Min. Quality Factor	L/Q Test Freq.	Max. DC Resistance	Max. Rated Current	Min. Self-resonant Frequency
Units	nH	-	-	MHz	$\Omega$	mA	MHz
Symbol	L	-	Q	Freq.	DCR	I <sub>r</sub>	S.R.F
SDWL3216CR27□STF	270	G,J,K	50	50/300	0.56	630	730
SDWL3216CR29□STF	290	G,J,K	50	50/250	0.6	610	700
SDWL3216CR33□STF	330	G,J,K	45	50/150	0.70	590	650
SDWL3216CR39□STF	390	G,J,K	45	50/150	0.80	530	600
SDWL3216CR47□STF	470	G,J,K	45	50/150	1.30	490	550
SDWL3216CR56□STF	560	G,J,K	45	35/150	1.34	460	470
SDWL3216CR62□STF	620	G,J,K	50	35/150	1.58	430	450
SDWL3216CR68□STF	680	G,J,K	45	35/150	1.58	430	450
SDWL3216CR82□STF	820	G,J,K	45	35/150	1.82	400	420
SDWL3216CR91□STF	910	G,J,K	45	35/150	2.6	320	400
SDWL3216C1R0□STF	1000	G,J,K	45	35/150	2.80	320	400
SDWL3216C1R2□STF	1200	G,J,K	45	35/150	3.20	300	380

### SDWL3225C TYPE

Part Number	Inductance	Tolerance	Min. Quality Factor	L/Q Test Freq.	Max. DC Resistance	Max. Rated Current	Min. Self-resonant Frequency
Units	nH	-	-	MHz	$\Omega$	mA	MHz
Symbol	L	-	Q	Freq.	DCR	I <sub>r</sub>	S.R.F
SDWL3225C3N9□STF	3.9	J,K	30	100/300	0.05	1000	6000
SDWL3225C4N7□STF	4.7	J,K	30	100/300	0.065	1000	5800
SDWL3225C8N2□STF	8.2	J,K	30	100/300	0.07	1000	5500
SDWL3225C10N□STF	10	G,J,K	40	100/300	0.08	1000	4000
SDWL3225C12N□STF	12	G,J,K	40	100/300	0.08	1000	3200
SDWL3225C15N□STF	15	G,J,K	40	100/300	0.10	1000	3200
SDWL3225C18N□STF	18	G,J,K	50	100/300	0.10	1000	2800
SDWL3225C22N□STF	22	G,J,K	50	100/300	0.10	1000	2200
SDWL3225C27N□STF	27	G,J,K	50	100/300	0.11	1000	1800
SDWL3225C30N□STF	30	G,J,K	50	100/300	0.11	900	1800
SDWL3225C33N□STF	33	G,J,K	55	100/300	0.11	1000	1800
SDWL3225C39N□STF	39	G,J,K	55	100/300	0.12	1000	1500
SDWL3225C43N□STF	43	G,J,K	55	100/300	0.12	1000	1500
SDWL3225C47N□STF	47	G,J,K	55	100/300	0.13	1000	1500
SDWL3225C51N□STF	51	G,J,K	50	100/300	0.14	1000	1450
SDWL3225C56N□STF	56	G,J,K	55	100/300	0.14	1000	1450
SDWL3225C68N□STF	68	G,J,K	55	100/300	0.15	900	1200
SDWL3225C82N□STF	82	G,J,K	55	100/300	0.20	900	1000
SDWL3225CR10□STF	100	G,J,K	55	100/300	0.20	850	900
SDWL3225CR12□STF	120	G,J,K	60	100/300	0.25	800	800
SDWL3225CR13□STF	130	G,J,K	60	100/300	0.25	800	800
SDWL3225CR15□STF	150	G,J,K	60	100/300	0.25	750	700
SDWL3225CR18□STF	180	G,J,K	60	50/300	0.30	700	650
SDWL3225CR22□STF	220	G,J,K	60	50/300	0.40	770	650
SDWL3225CR24□STF	240	G,J,K	60	50/300	0.40	500	580
SDWL3225CR27□STF	270	G,J,K	40	50/300	0.40	630	580
SDWL3225CR29□STF	290	G,J,K	45	50/150	0.40	600	580
SDWL3225CR33□STF	330	G,J,K	45	50/150	0.58	590	580
SDWL3225CR39□STF	390	G,J,K	45	50/150	0.58	530	510
SDWL3225CR47□STF	470	G,J,K	45	50/150	0.80	490	480

## SPECIFICATIONS

### SDWL3225C TYPE

Part Number	Inductance	Tolerance	Min. Quality Factor	L/Q Test Freq.	Max. DC Resistance	Max. Rated Current	Min. Self-resonant Frequency
Units	nH	-	-	MHz	$\Omega$	mA	MHz
Symbol	L	-	Q	Freq.	DCR	I <sub>r</sub>	S.R.F
SDWL3225CR56□STF	560	G,J,K	45	35/150	1.10	460	420
SDWL3225CR60□STF	600	G,J,K	45	35/150	1.15	450	420
SDWL3225CR68□STF	680	G,J,K	45	35/150	1.20	430	400
SDWL3225CR82□STF	820	G,J,K	45	35/150	1.82	400	370
SDWL3225C1R0□STF	1000	G,J,K	45	35/150	1.85	320	340
SDWL3225C1R2□STF	1200	G,J,K	35	35/150	1.87	300	220
SDWL3225C1R5□STF	1500	G,J,K	20	7.9/50	1.95	310	160
SDWL3225C1R8□STF	1800	G,J,K	30	7.9/50	2.25	310	160
SDWL3225C2R2□STF	2200	G,J,K	25	7.9/50	2.41	310	130
SDWL3225C2R7□STF	2700	G,J,K	25	7.9/50	2.85	300	110
SDWL3225C3R0□STF	3000	G,J,K	20	7.9/25	3.12	300	110
SDWL3225C3R3□STF	3300	G,J,K	20	7.9/25	3.14	290	100
SDWL3225C3R9□STF	3900	G,J,K	20	7.9/25	3.60	290	60
SDWL3225C4R7□STF	4700	G,J,K	20	7.9/25	4.00	280	60
SDWL3225C5R6□STF	5600	G,J,K	15	7.9/25	5.00	250	50
SDWL3225C6R8□STF	6800	G,J,K	15	7.9	8.00	230	40
SDWL3225C8R2□STF	8200	G,J,K	15	7.9	9.00	200	40
SDWL3225C8R6□STF	8600	G,J,K	15	7.9	9.00	200	40
SDWL3225C100□STF	10000	G,J,K	15	7.9	13.2	120	35
SDWL3225C220□STF	22000	G,J,K	15	7.9	18	100	20

### SDWL4532C TYPE

Part Number	Inductance	Tolerance	Min. Quality Factor	L/Q Test Freq.	Max. DC Resistance	Max. Rated Current	Min. Self-resonant Frequency
Units	$\mu$ H	-	-	MHz	$\Omega$	mA	MHz
Symbol	L	-	Q	Freq.	DCR	I <sub>r</sub>	S.R.F
SDWL4532C24N□STF	0.024	G,J,K	30	7.9/50	0.1	1000	2000
SDWL4532C82N□STF	0.082	G,J,K	30	7.9/50	0.4	500	700
SDWL4532C90N□STF	0.090	G,J,K	30	7.9/50	0.45	500	700
SDWL4532C93N□STF	0.093	G,J,K	30	7.9/50	0.45	500	700
SDWL4532CR10□STF	0.100	G,J,K	30	7.9/50	0.5	500	700
SDWL4532CR12□STF	0.120	G,J,K	30	7.9/50	0.5	500	700
SDWL4532CR15□STF	0.150	G,J,K	75	7.9/100	0.3	1000	700
SDWL4532CR18□STF	0.180	G,J,K	30	7.9/50	0.6	500	700
SDWL4532CR22□STF	0.220	G,J,K	80	7.9/100	0.35	900	750
SDWL4532CR27□STF	0.270	G,J,K	60	50/50	0.16	900	580
SDWL4532CR33□STF	0.330	G,J,K	80	7.9/100	0.42	850	485
SDWL4532CR68□STF	0.668	G,J,K	50	7.9/50	0.9	500	400
SDWL4532C1R0□STF	1.0	G,J,K	60	7.9/50	1.2	480	250
SDWL4532C1R1□STF	1.1	G,J,K	50	100/100	1.2	480	240
SDWL4532C1R2□STF	1.2	G,J,K	60	7.9/50	1.2	480	230
SDWL4532C1R5□STF	1.5	G,J,K	60	7.9/50	1.6	430	210
SDWL4532C1R6□STF	1.6	G,J,K	60	7.9/50	1.6	430	210
SDWL4532C1R8□STF	1.8	G,J,K	55	7.9/50	2.0	380	150
SDWL4532C2R1□STF	2.1	G,J,K	55	7.9/50	2.2	340	150
SDWL4532C2R2□STF	2.2	G,J,K	55	7.9/50	2.2	340	150

# SPECIFICATIONS

## SDWL4532C TYPE

Part Number	Inductance	Tolerance	Min. Quality Factor	L/Q Test Freq.	Max. DC Resistance	Max. Rated Current	Min. Self-resonant Frequency
Units	uH	-	-	MHz	$\Omega$	mA	MHz
Symbol	L	-	Q	Freq.	DCR	I <sub>r</sub>	S.R.F
SDWL4532C2R7□STF	2.7	G,J,K	55	7.9/50	3.2	300	150
SDWL4532C3R3□STF	3.3	G,J,K	55	7.9/50	3.8	270	130
SDWL4532C3R9□STF	3.9	G,J,K	55	7.9/50	5.0	240	120
SDWL4532C4R7□STF	4.7	G,J,K	55	7.9/50	5.4	230	90
SDWL4532C5R6□STF	5.6	G,J,K	45	7.9/50	5.7	220	90
SDWL4532C6R2□STF	6.2	G,J,K	35	7.9/50	6.4	200	80
SDWL4532C6R8□STF	6.8	G,J,K	30	7.9/50	6.6	210	80
SDWL4532C8R2□STF	8.2	G,J,K	20	7.9/50	7.0	200	70
SDWL4532C100□STF	10	G,J,K	15	7.9/50	7.7	190	60
SDWL4532C120□STF	12	G,J,K	30	2.5/10	8.7	180	50
SDWL4532C150□STF	15	G,J,K	30	2.5/10	9.6	170	30
SDWL4532C180□STF	18	G,J,K	25	2.5/10	10.5	160	30
SDWL4532C220□STF	22	G,J,K	25	2.5/10	11.5	155	20
SDWL4532C270□STF	27	G,J,K	25	2.5/10	12.5	150	20
SDWL4532C330□STF	33	G,J,K	10	2.5/10	13.5	145	10

※□: Please specify the inductance tolerance code (B=±0.1nH, C=±0.2nH, S=±0.3nH, D=±0.5nH, G=±2%, H=±3%, J=±5%, K=±10%).

※: Please refer to "Measurement Notice For RF Inductors".

# TYPICAL ELECTRICAL CHARACTERISTICS

## SDWL1608C-S TYPE

Inductance vs. Frequency Characteristics

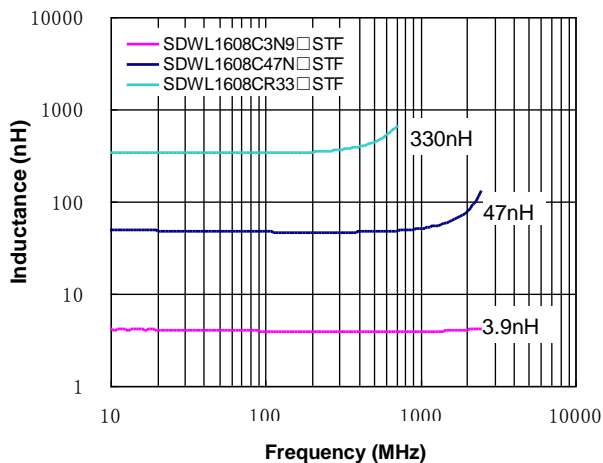

Q vs. Frequency Characteristics

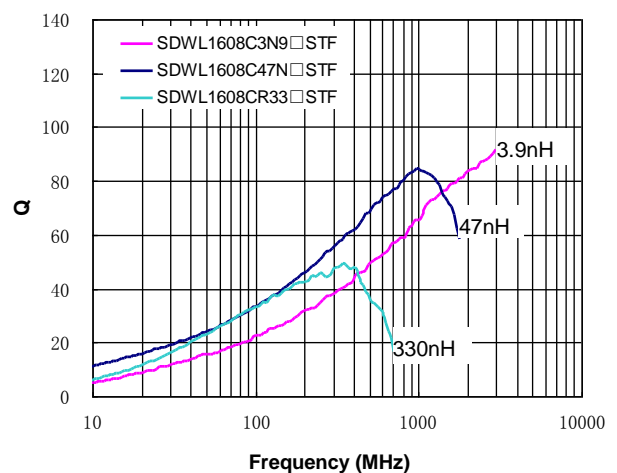

# TYPICAL ELECTRICAL CHARACTERISTICS

## SDWL2012C TYPE

Inductance vs. Frequency Characteristics

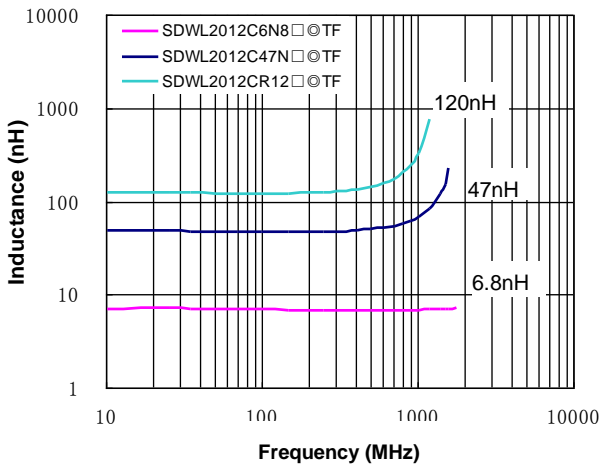

Q vs. Frequency Characteristics

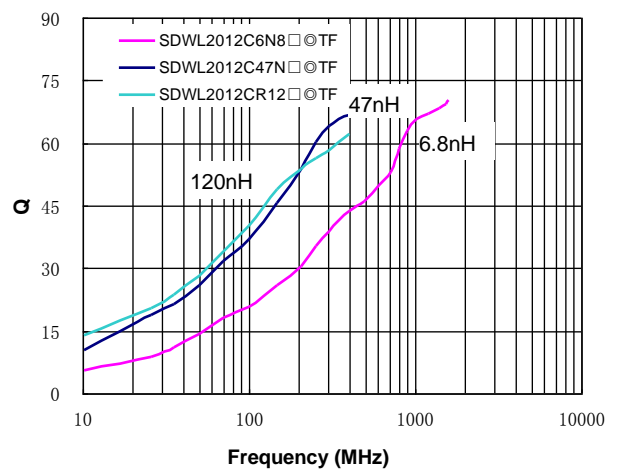

## SDWL2520C TYPE

Inductance vs. Frequency Characteristics

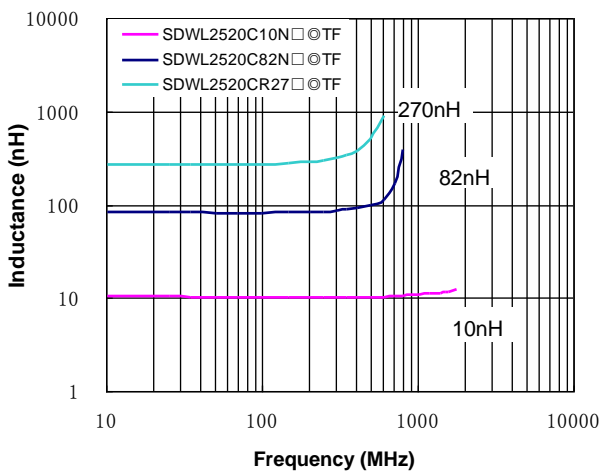

Q vs. Frequency Characteristics

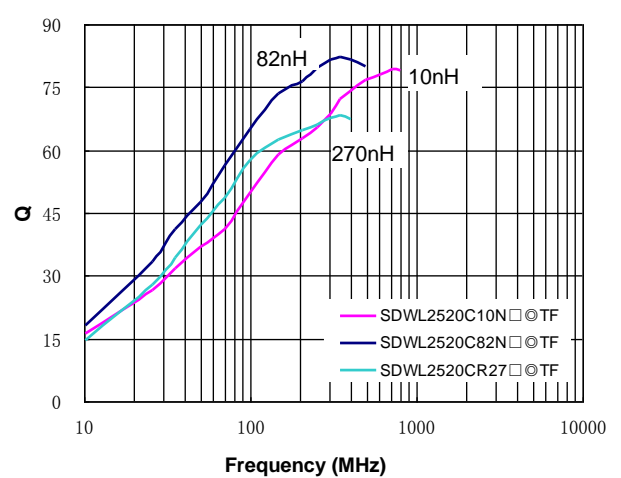

## SDWL3216C TYPE

Inductance vs. Frequency Characteristics

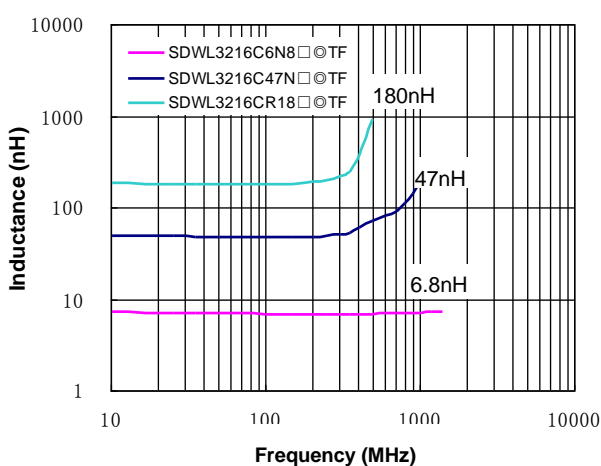

Q vs. Frequency Characteristics

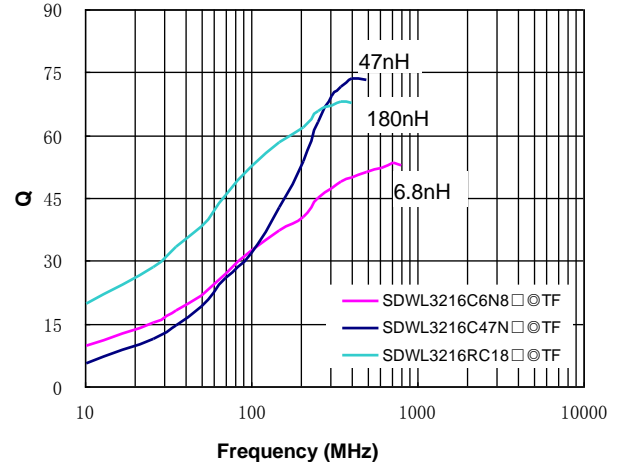

# TYPICAL ELECTRICAL CHARACTERISTICS

## SDWL3225C TYPE

Inductance vs. Frequency Characteristics

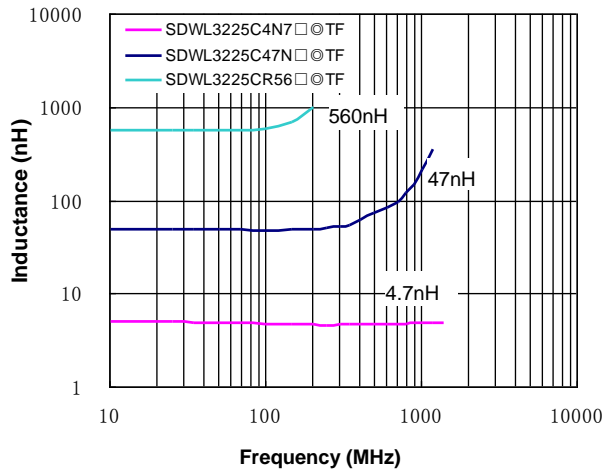

Q vs. Frequency Characteristics

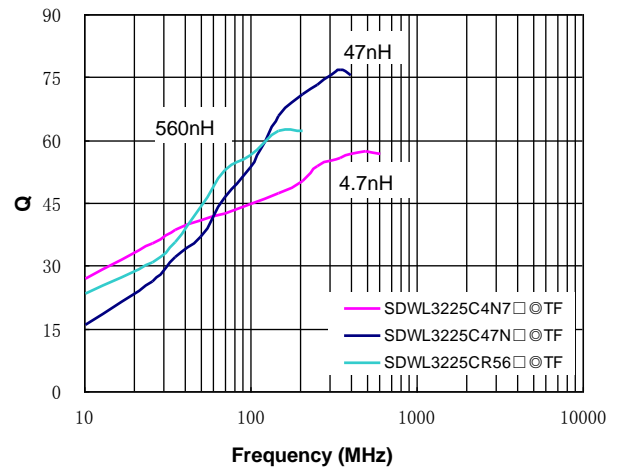

## SDWL4532C TYPE

Inductance vs. Frequency Characteristics

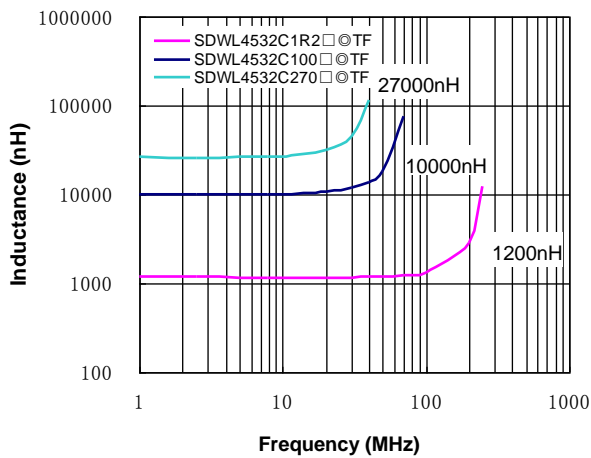

Q vs. Frequency Characteristics

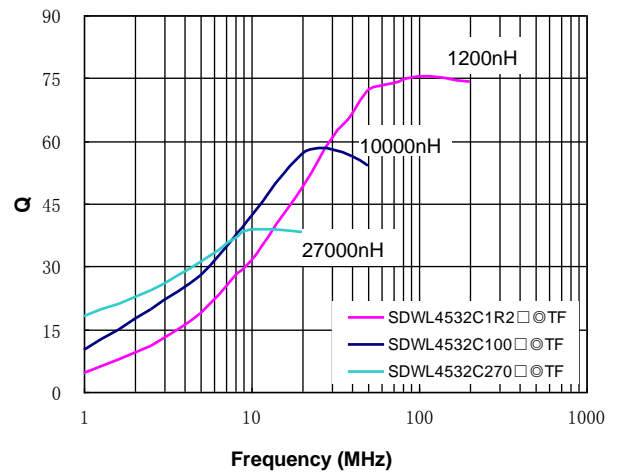

## X-ON Electronics

Largest Supplier of Electrical and Electronic Components

*Click to view similar products for [Fixed Inductors](#) category:*

*Click to view products by [Sunlord](#) manufacturer:*

Other Similar products are found below :

[MLZ1608M6R8WTD25](#) [MLZ1608N6R8LT000](#) [MLZ1608N3R3LTD25](#) [MLZ1608N3R3LT000](#) [MLZ1608N150LT000](#)  
[MLZ1608M150WTD25](#) [MLZ1608M3R3WTD25](#) [MLZ1608M3R3WT000](#) [MLZ1608M150WT000](#) [MLZ1608A1R5WT000](#)  
[MLZ1608N1R5LT000](#) [B82432C1333K000](#) [PCMB053T-1R0MS](#) [PCMB053T-1R5MS](#) [PCMB104T-1R5MS](#) [CR32NP-100KC](#) [CR32NP-151KC](#) [CR32NP-180KC](#) [CR32NP-181KC](#) [CR32NP-1R5MC](#) [CR32NP-390KC](#) [CR32NP-3R9MC](#) [CR32NP-680KC](#) [CR32NP-820KC](#)  
[CR32NP-8R2MC](#) [CR43NP-390KC](#) [CR43NP-560KC](#) [CR43NP-680KC](#) [CR54NP-181KC](#) [CR54NP-470LC](#) [CR54NP-820KC](#) [CR54NP-8R5MC](#)  
[ET3542-057](#) [MGDQ4-00004-P](#) [MGDU1-00016-P](#) [MHL1ECTTP18NJ](#) [MHL1JCTTD12NJ](#) [PE-51506NL](#) [PE-53601NL](#) [PE-53630NL](#) [PE-53824SNLT](#) [PE-62892NL](#) [PE-92100NL](#) [PG0434.801NLT](#) [PG0936.113NLT](#) [PM06-2N7](#) [PM06-39NJ](#) [HC2LP-R47-R](#) [HC2-R47-R](#) [HC3-2R2-R](#)