

Multilayer Chip Antenna – SLDA Series

Operating Temp. : -40°C~+85°C

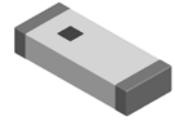

FEATURES

- Light weight, compact
- Wide bandwidth, low cost
- Built-in antenna with high gain

APPLICATIONS

- Bluetooth, Wireless LAN, Mobile TV
- Home RF system, etc.

PRODUCT IDENTIFICATION

<u>SLDA</u> ①	<u>31</u> ②	<u>-2R800G</u> ③	<u>-S1</u> ④	<u>I</u> ⑤	<u>F</u> ⑥																																						
①	②	③	④	⑤	⑥																																						
<table border="1"> <tr><th colspan="2">Type</th></tr> <tr><td>SLDA</td><td>Multilayer Chip Antenna</td></tr> </table>	Type		SLDA	Multilayer Chip Antenna	<table border="1"> <tr><th colspan="2">External Dimensions (LxW) (mm)</th></tr> <tr><td>31</td><td>3.2x1.6</td></tr> <tr><td>52</td><td>5.2x2.1</td></tr> <tr><td>62</td><td>6.0x2.0</td></tr> <tr><td>72</td><td>7.0x2.0</td></tr> <tr><td>81</td><td>8.0x1.0</td></tr> <tr><td>92</td><td>9.0x2.0</td></tr> </table>	External Dimensions (LxW) (mm)		31	3.2x1.6	52	5.2x2.1	62	6.0x2.0	72	7.0x2.0	81	8.0x1.0	92	9.0x2.0	<table border="1"> <tr><th colspan="2">Center Frequency</th></tr> <tr><th>Example</th><th>Nominal Value</th></tr> <tr><td>2R800G</td><td>2800.0MHz</td></tr> <tr><td>2R450G</td><td>2450.0MHz</td></tr> </table>	Center Frequency		Example	Nominal Value	2R800G	2800.0MHz	2R450G	2450.0MHz	<table border="1"> <tr><th colspan="2">Series Code</th></tr> <tr><td>S1, 01, etc.</td><td></td></tr> </table>	Series Code		S1, 01, etc.		<table border="1"> <tr><th colspan="2">Packing</th></tr> <tr><td>T</td><td>Tape & Reel</td></tr> </table>	Packing		T	Tape & Reel	<table border="1"> <tr><th colspan="2">Hazardous Substance Free Products</th></tr> <tr><td>F</td><td></td></tr> </table>	Hazardous Substance Free Products		F	
Type																																											
SLDA	Multilayer Chip Antenna																																										
External Dimensions (LxW) (mm)																																											
31	3.2x1.6																																										
52	5.2x2.1																																										
62	6.0x2.0																																										
72	7.0x2.0																																										
81	8.0x1.0																																										
92	9.0x2.0																																										
Center Frequency																																											
Example	Nominal Value																																										
2R800G	2800.0MHz																																										
2R450G	2450.0MHz																																										
Series Code																																											
S1, 01, etc.																																											
Packing																																											
T	Tape & Reel																																										
Hazardous Substance Free Products																																											
F																																											

SHAPE AND LAND PATTERN

Type:	Dimensions (mm)
Type: SLDA21-2R450G-S1TF	Land Pattern (mm)

SHAPE AND DIMENSIONS

Series	A	B	C	D	E	F	G	H	I	J
SLDA31	3.2±0.2	1.6±0.2	1.2±0.2	0.5±0.2	1.6±0.2	0.8±0.2	0.8±0.2	2.2±0.2	1.4	1.6±0.2
SLDA52	5.2±0.2	2.1±0.2	1.0±0.2	0.5±0.2	2.3±0.2	1.5±0.2	1.0±0.2	4.0±0.2	1.4	2.3±0.2
SLDA62	6.0±0.2	2.0±0.2	1.0±0.2	0.5±0.2	2.2±0.2	1.5±0.2	1.0±0.2	5.0±0.2	1.4	2.2±0.2
SLDA72	7.0±0.2	2.0±0.2	1.0±0.2	0.5±0.2	2.2±0.2	1.5±0.2	1.0±0.2	6.0±0.2	1.4	2.2±0.2
SLDA81	8.0±0.2	1.0±0.2	1.0±0.2	0.5±0.2	1.5±0.2	1.5±0.2	1.0±0.2	7.0±0.2	1.4	1.5±0.2
SLDA92	9.0±0.2	2.0±0.2	1.0±0.2	0.5±0.2	2.2±0.2	1.5±0.2	1.0±0.2	8.0±0.2	1.4	2.2±0.2

TERINAL-CONFIGURATION



No.	Terminal Name	No.	Terminal Name
(1)	Feeding Point	(2)	NC

EVALUATION BOARD

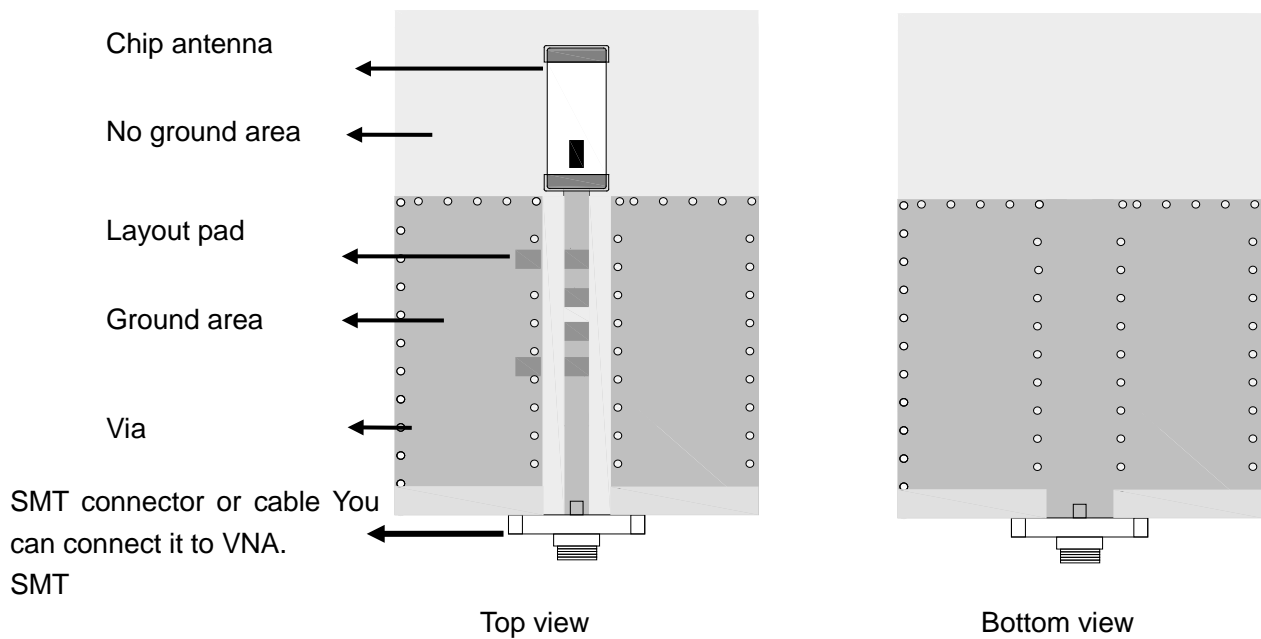

APPLICATION GUIDE

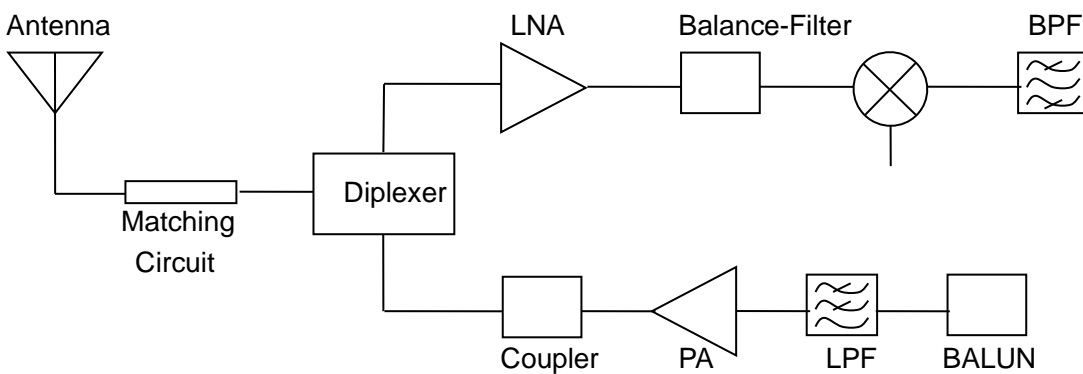

SPECIFICATIONS

SLDA31 TYPE

Part Number	Band Width	Peak Gain	Average Gain	VSWR	Impedance	Power Capacity
	MHz	V-XZ	V-XZ	In BW	Ω	W
SLDA31-2R800G-S1TF	≥ 100	0.5dBi Typ.	-1dBi Typ.	<2	50	3
SLDA31-2R400G-S1TF	≥ 100	2.5dB @ (XZ-total)	-1.5dB @ (XZ-total)	<2	50	2
SLDA31-2R450G-S2TF	≥ 100	2.5dBi @ (XZ-total)	0.5dBi @ (XZ-total)	<2	50	2

SLDA52 TYPE

Part Number	Band Width	Peak Gain	Average Gain	VSWR	Impedance	Power Capacity
	MHz	V-XZ	V-XZ	In BW	Ω	W
SLDA52-2R510G-S1TF	≥ 200	2.5dBi Typ.	0.5dBi Typ.	<2	50	
SLDA52-2R540G-S1TF	≥ 200	2.5dBi Typ.	0.5dBi Typ.	<2	50	

SLDA62 TYPE

Part Number	Band Width	Peak Gain	Average Gain	VSWR	Impedance	Power Capacity
	MHz	V-XZ	V-XZ	In BW	Ω	W
SLDA62-2R640G-01TF	≥ 200	2.6dBi Typ.	0.7dBi Typ.	<2	50	3

SLDA72 TYPE

Part Number	Band Width	Peak Gain	Average Gain	VSWR	Impedance	Power Capacity
	MHz	V-XZ	V-XZ	In BW	Ω	W
SLDA72-2R470G-S1TF	≥ 200	2.7dBi Typ.	1.0dBi Typ.	<2	50	3

SLDA81 TYPE

Part Number	Band Width	Peak Gain	Average Gain	VSWR	Impedance	Power Capacity
	MHz	V-XZ	V-XZ	In BW	Ω	W
SLDA81-3R010G-S1TF	≥ 200	2.0dBi Typ.	0.5dBi Typ.	<2	50	3

SLDA92 TYPE

Part Number	Band Width	Peak Gain	Average Gain	VSWR	Impedance	Power Capacity
	MHz	V-XZ	V-XZ	In BW	Ω	W
SLDA92-2R660G-S1TF	≥ 200	3.0dBi Typ.	1.0dBi Typ.	<2	50	3

※Frequency will be changed with layout of PCB. Please contact us for appropriate design.

RETURN LOSS

SLDA31-2R800G-S1TF

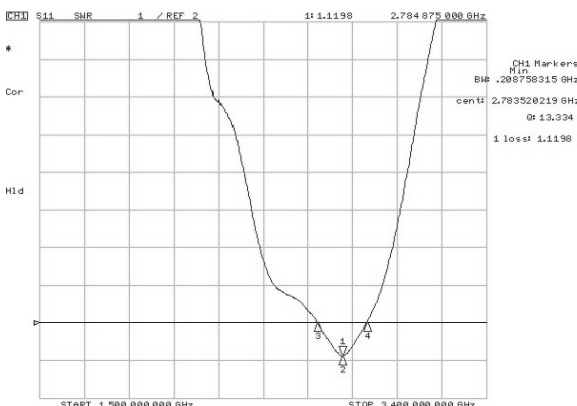

SLDA31-2R400G-S1TF

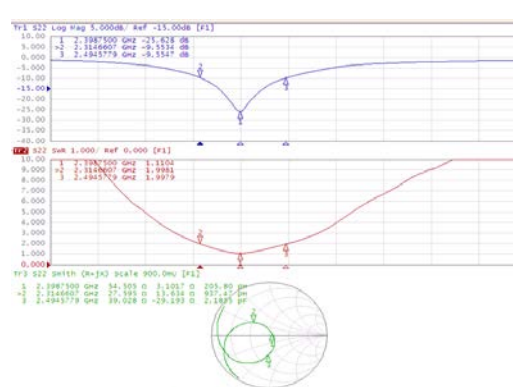

RETURN LOSS

SLDA31-2R450G-S2TF

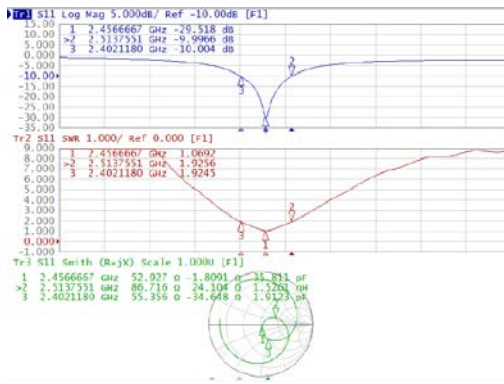

SLDA52-2R510G-S1TF

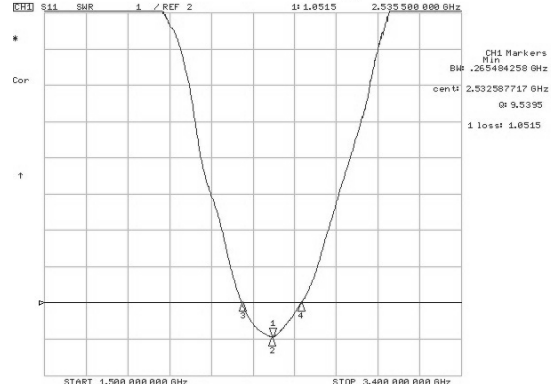

SLDA52-2R540G-S1TF

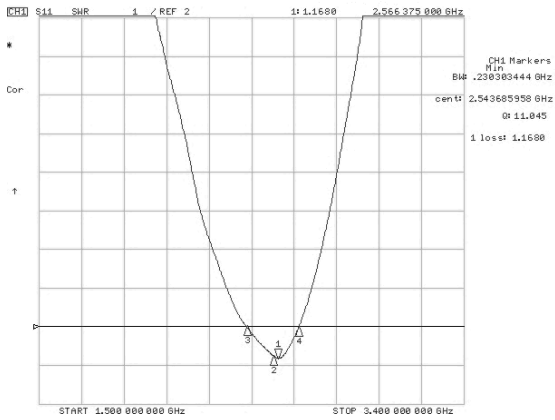

SLDA62-2R640G-01TF

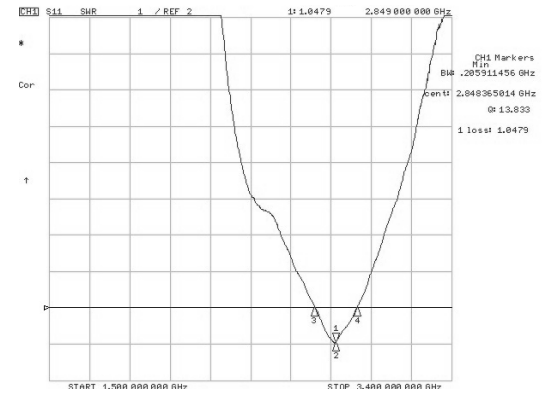

SLDA72-2R470G-S1TF

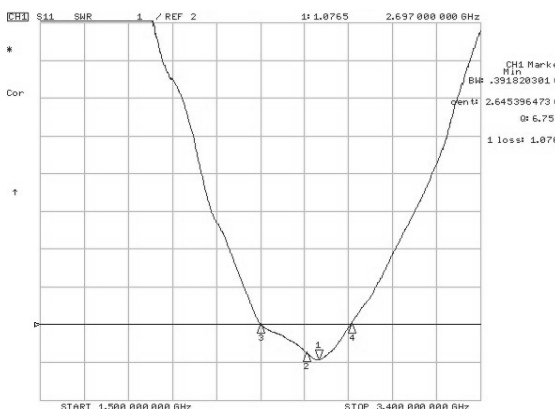

SLDA81-3R010G-S1TF

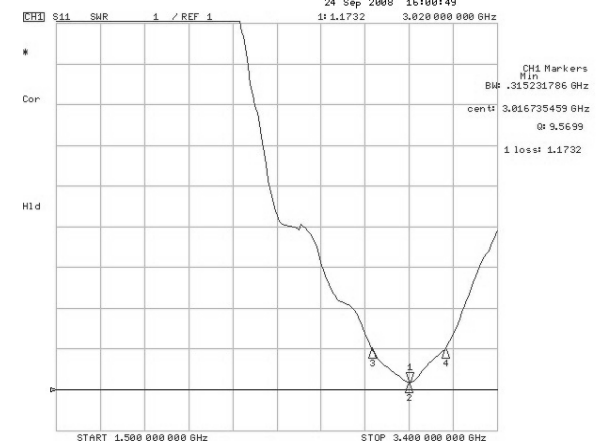

SLDA92-2R660G-S1TF

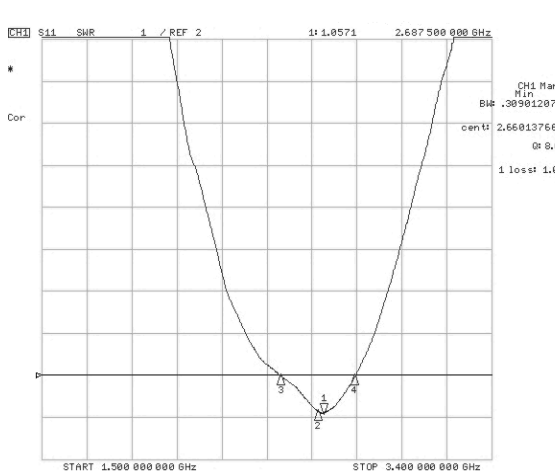

X-ON Electronics

Largest Supplier of Electrical and Electronic Components

Click to view similar products for [Antennas](#) category:

Click to view products by [Sunlord](#) manufacturer:

Other Similar products are found below :

[GAN30084EU](#) [930-033-R](#) [EXE902SM](#) [APAMPG-117](#) [MAF94383](#) [W6102B0100](#) [SPDA17RP918](#) [A09-F5NF-M](#) [RGFRA1903041A1T](#) [108-00016-050](#) [W3921B0100](#) [SIMNA-868](#) [SIMNA-915](#) [SIMNA-433](#) [W1049B090](#) [TRABT1560](#) [A75-001](#) [W3118A](#) [WTL2449CQ1-FRSMM](#) [CPL9C](#) [0600-00060](#) [GD5W-28P-NF](#) [MA9-7N](#) [GD53-25](#) [C37](#) [MAF94051](#) [FRX380](#) [MA9-5N](#) [B1322NR](#) [QWFTB120](#) [MAF94271](#) [MAF94300](#) [GPSMB301](#) [FG4403](#) [PSQ24495-91RSM](#) [MIKROE-2393](#) [DA5-32RADOME](#) [5200227](#) [GPSCPMM00](#) [W1049B030](#) [SPDA17RP918](#) [GPSCP00](#) [AN 303](#) [ANTDOM-05-01-WPM](#) [EXW30BNX](#) [OSCAR1A/5M/SMAM/S/S/31](#) [ALPHA4A/1M/SMAM/S/S/26](#) [OSCAR1A/10M/SMAM/S/S/31](#) [OSCAR40/5M/LL/SMAM/S/S/33](#) [OSCAR40/10M/LL/SMAM/S/S/33](#)