

Multilayer Chip Antenna – SLDA Series

Operating Temp. : -40°C~+85°C

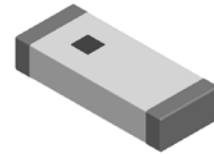

FEATURES

- Light weight, compact
- Wide bandwidth, low cost
- Built-in antenna with high gain

APPLICATIONS

- Bluetooth, Wireless LAN, Mobile TV
- Home RF system, etc

PRODUCT IDENTIFICATION

| <u>SLDA</u> ① | <u>31</u> ② | <u>-2R800G</u> ③ | <u>-S1</u> ④ | <u>T</u> ⑤ | <u>F</u> ⑥ | | | | | | | | | | | | | | | | | | | | | | | | | | | | | | | | | | | | |
|--|-------------------------|---------------------|-----------------|-------------------------|---|------------|--|--------------------------------|--|----|---------|----|---------|----|---------|----|---------|----|---------|----|---------|----|---------|---|------------------|--|---------|---------------|--------|-----------|--------|-----------|--|-------------|--------------|--|---------|--------------------|--|-----------------------------------|---|
| ① | ② | ③ | ④ | ⑤ | ⑥ | | | | | | | | | | | | | | | | | | | | | | | | | | | | | | | | | | | | |
| <table border="1"> <thead> <tr> <th colspan="2">Type</th> </tr> </thead> <tbody> <tr> <td>SLDA</td> <td>Multilayer Chip Antenna</td> </tr> </tbody> </table> | Type | | SLDA | Multilayer Chip Antenna | <table border="1"> <thead> <tr> <th colspan="2">(LxW) (mm)</th> </tr> <tr> <th colspan="2">External Dimensions (LxW) (mm)</th> </tr> </thead> <tbody> <tr> <td>21</td> <td>2.0x1.2</td> </tr> <tr> <td>31</td> <td>3.2x1.6</td> </tr> <tr> <td>52</td> <td>5.2x2.1</td> </tr> <tr> <td>62</td> <td>6.0x2.0</td> </tr> <tr> <td>72</td> <td>7.0x2.0</td> </tr> <tr> <td>81</td> <td>8.0x1.0</td> </tr> <tr> <td>92</td> <td>9.0x2.0</td> </tr> </tbody> </table> | (LxW) (mm) | | External Dimensions (LxW) (mm) | | 21 | 2.0x1.2 | 31 | 3.2x1.6 | 52 | 5.2x2.1 | 62 | 6.0x2.0 | 72 | 7.0x2.0 | 81 | 8.0x1.0 | 92 | 9.0x2.0 | <table border="1"> <thead> <tr> <th colspan="2">Center Frequency</th> </tr> <tr> <th>Example</th> <th>Nominal Value</th> </tr> </thead> <tbody> <tr> <td>2R800G</td> <td>2800.0MHz</td> </tr> <tr> <td>2R450G</td> <td>2450.0MHz</td> </tr> </tbody> </table> | Center Frequency | | Example | Nominal Value | 2R800G | 2800.0MHz | 2R450G | 2450.0MHz | <table border="1"> <thead> <tr> <th>Series Code</th> </tr> </thead> <tbody> <tr> <td>S1, 01, etc.</td> </tr> </tbody> </table> | Series Code | S1, 01, etc. | <table border="1"> <thead> <tr> <th>Packing</th> </tr> </thead> <tbody> <tr> <td>T Tape & Reel</td> </tr> </tbody> </table> | Packing | T Tape & Reel | <table border="1"> <tbody> <tr> <td style="text-align: center;">Hazardous Substance Free Products</td> </tr> <tr> <td style="text-align: center;">F</td> </tr> </tbody> </table> | Hazardous Substance Free Products | F |
| Type | | | | | | | | | | | | | | | | | | | | | | | | | | | | | | | | | | | | | | | | | |
| SLDA | Multilayer Chip Antenna | | | | | | | | | | | | | | | | | | | | | | | | | | | | | | | | | | | | | | | | |
| (LxW) (mm) | | | | | | | | | | | | | | | | | | | | | | | | | | | | | | | | | | | | | | | | | |
| External Dimensions (LxW) (mm) | | | | | | | | | | | | | | | | | | | | | | | | | | | | | | | | | | | | | | | | | |
| 21 | 2.0x1.2 | | | | | | | | | | | | | | | | | | | | | | | | | | | | | | | | | | | | | | | | |
| 31 | 3.2x1.6 | | | | | | | | | | | | | | | | | | | | | | | | | | | | | | | | | | | | | | | | |
| 52 | 5.2x2.1 | | | | | | | | | | | | | | | | | | | | | | | | | | | | | | | | | | | | | | | | |
| 62 | 6.0x2.0 | | | | | | | | | | | | | | | | | | | | | | | | | | | | | | | | | | | | | | | | |
| 72 | 7.0x2.0 | | | | | | | | | | | | | | | | | | | | | | | | | | | | | | | | | | | | | | | | |
| 81 | 8.0x1.0 | | | | | | | | | | | | | | | | | | | | | | | | | | | | | | | | | | | | | | | | |
| 92 | 9.0x2.0 | | | | | | | | | | | | | | | | | | | | | | | | | | | | | | | | | | | | | | | | |
| Center Frequency | | | | | | | | | | | | | | | | | | | | | | | | | | | | | | | | | | | | | | | | | |
| Example | Nominal Value | | | | | | | | | | | | | | | | | | | | | | | | | | | | | | | | | | | | | | | | |
| 2R800G | 2800.0MHz | | | | | | | | | | | | | | | | | | | | | | | | | | | | | | | | | | | | | | | | |
| 2R450G | 2450.0MHz | | | | | | | | | | | | | | | | | | | | | | | | | | | | | | | | | | | | | | | | |
| Series Code | | | | | | | | | | | | | | | | | | | | | | | | | | | | | | | | | | | | | | | | | |
| S1, 01, etc. | | | | | | | | | | | | | | | | | | | | | | | | | | | | | | | | | | | | | | | | | |
| Packing | | | | | | | | | | | | | | | | | | | | | | | | | | | | | | | | | | | | | | | | | |
| T Tape & Reel | | | | | | | | | | | | | | | | | | | | | | | | | | | | | | | | | | | | | | | | | |
| Hazardous Substance Free Products | | | | | | | | | | | | | | | | | | | | | | | | | | | | | | | | | | | | | | | | | |
| F | | | | | | | | | | | | | | | | | | | | | | | | | | | | | | | | | | | | | | | | | |

SHAPE AND DIMENSIONS

| Type: | Dimensions (mm) |
|--------------------------|-------------------|
| | |
| Type: SLDA21-2R450G-S1TF | Land Pattern (mm) |
| | |

SHAPE AND DIMENSIONS

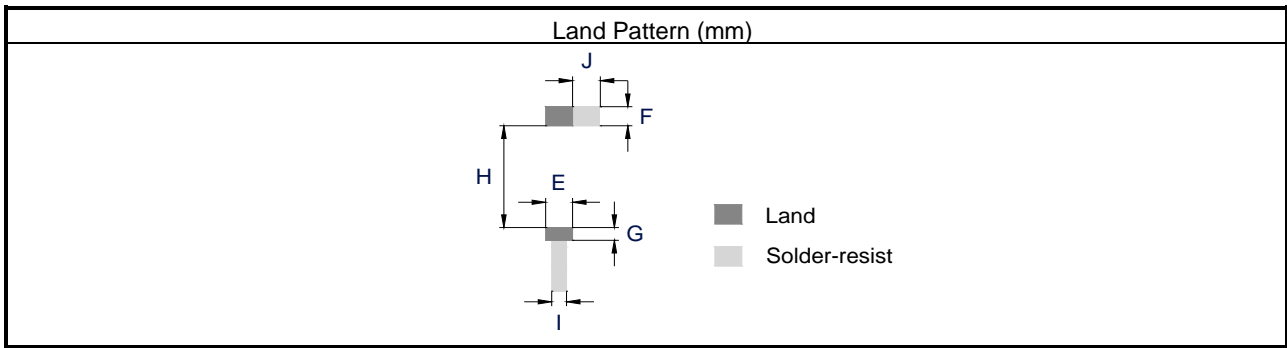

SHAPE AND DIMENSIONS

| Series | A | B | C | D | E | F | G | H | I | J |
|--------|---------|----------|----------|---------|---------|---------|---------|---------|-----|---------|
| SLDA21 | 2.0±0.2 | 1.25±0.2 | 0.85±0.2 | 0.5±0.2 | 1.0±0.2 | 1.0±0.2 | 1.5±0.2 | - | - | - |
| SLDA31 | 3.2±0.2 | 1.6±0.2 | 1.2±0.2 | 0.5±0.2 | 1.6±0.2 | 0.8±0.2 | 0.8±0.2 | 2.2±0.2 | 1.4 | 1.6±0.2 |
| SLDA52 | 5.2±0.2 | 2.1±0.2 | 1.0±0.2 | 0.5±0.2 | 2.3±0.2 | 1.5±0.2 | 1.0±0.2 | 4.0±0.2 | 1.4 | 2.3±0.2 |
| SLDA62 | 6.0±0.2 | 2.0±0.2 | 1.0±0.2 | 0.5±0.2 | 2.2±0.2 | 1.5±0.2 | 1.0±0.2 | 5.0±0.2 | 1.4 | 2.2±0.2 |
| SLDA72 | 7.0±0.2 | 2.0±0.2 | 1.0±0.2 | 0.5±0.2 | 2.2±0.2 | 1.5±0.2 | 1.0±0.2 | 6.0±0.2 | 1.4 | 2.2±0.2 |
| SLDA81 | 8.0±0.2 | 1.0±0.2 | 1.0±0.2 | 0.5±0.2 | 1.5±0.2 | 1.5±0.2 | 1.0±0.2 | 7.0±0.2 | 1.4 | 1.5±0.2 |
| SLDA92 | 9.0±0.2 | 2.0±0.2 | 1.0±0.2 | 0.5±0.2 | 2.2±0.2 | 1.5±0.2 | 1.0±0.2 | 8.0±0.2 | 1.4 | 2.2±0.2 |

TERINAL-CONFIGURATION



| No. | Terminal Name | No. | Terminal Name |
|-----|---------------|-----|---------------|
| (1) | Feeding Point | (2) | NC |

EVALUATION BOARD

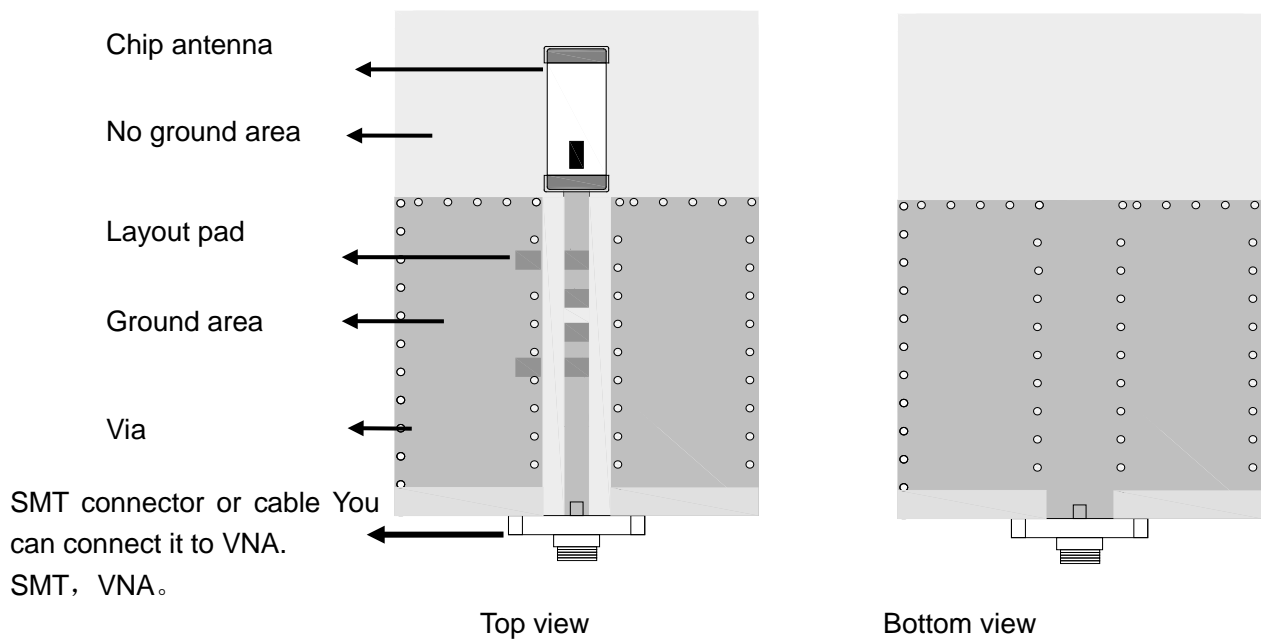

APPLICATION GUIDE

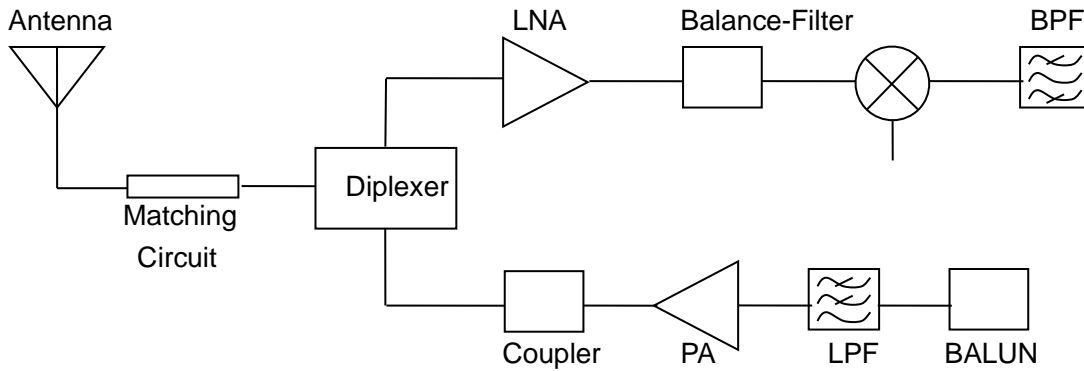

SPECIFICATIONS

SLDA21 TYPE

| Part Number | Band Width | Peak Gain | Average Gain | VSWR | Impedance | Power Capacity |
|--------------------|------------|-------------|--------------|-------|-----------|----------------|
| | MHz | V-XZ | V-XZ | In BW | Ω | W |
| SLDA21-2R450G-S1TF | ≥ 100 | 1.0dBi Typ. | -3.0dBi Typ. | <2.5 | 50 | 3 |

SLDA31 TYPE

| Part Number | Band Width | Peak Gain | Average Gain | VSWR | Impedance | Power Capacity |
|--------------------|------------|-------------------------|-------------------------|-------|-----------|----------------|
| | MHz | V-XZ | V-XZ | In BW | Ω | W |
| SLDA31-2R800G-S1TF | ≥ 100 | 0.5dBi Typ. | -1dBi Typ. | <2 | 50 | 3 |
| SLDA31-2R400G-S1TF | ≥ 100 | 2.5dB @ (XZ-total) | -1.5dB @ (XZ-total) | < 2 | 50 | 2 |
| SLDA31-2R450G-S2TF | ≥ 100 | 2.5dBi @ (XZ-total) | 0.5dBi @ (XZ-total) | < 2 | 50 | 2 |

SLDA52 TYPE

| Part Number | Band Width | Peak Gain | Average Gain | VSWR | Impedance | Power Capacity |
|--------------------|------------|-------------|--------------|-------|-----------|----------------|
| | MHz | V-XZ | V-XZ | In BW | Ω | W |
| SLDA52-2R510G-S1TF | ≥ 200 | 2.5dBi Typ. | 0.5dBi Typ. | <2 | 50 | |
| SLDA52-2R540G-S1TF | ≥ 200 | 2.5dBi Typ. | 0.5dBi Typ. | <2 | 50 | |

SLDA62 TYPE

| Part Number | Band Width | Peak Gain | Average Gain | VSWR | Impedance | Power Capacity |
|--------------------|------------|-------------|--------------|-------|-----------|----------------|
| | MHz | V-XZ | V-XZ | In BW | Ω | W |
| SLDA62-2R640G-01TF | ≥ 200 | 2.6dBi Typ. | 0.7dBi Typ. | <2 | 50 | 3 |

SLDA72 TYPE

| Part Number | Band Width | Peak Gain | Average Gain | VSWR | Impedance | Power Capacity |
|--------------------|------------|-------------|--------------|-------|-----------|----------------|
| | MHz | V-XZ | V-XZ | In BW | Ω | W |
| SLDA72-2R470G-S1TF | ≥ 200 | 2.7dBi Typ. | 1.0dBi Typ. | <2 | 50 | 3 |

SLDA81 TYPE

| Part Number | Band Width | Peak Gain | Average Gain | VSWR | Impedance | Power Capacity |
|--------------------|------------|-------------|--------------|-------|-----------|----------------|
| | MHz | V-XZ | V-XZ | In BW | Ω | W |
| SLDA81-3R010G-S1TF | ≥ 200 | 2.0dBi Typ. | 0.5dBi Typ. | <2 | 50 | 3 |

SPECIFICATIONS

SLDA92 TYPE

| Part Number | Band Width | Peak Gain | Average Gain | VSWR | Impedance | Power Capacity |
|--------------------|------------|-------------|--------------|-------|-----------|----------------|
| | MHz | V-XZ | V-XZ | In BW | Ω | W |
| SLDA92-2R660G-S1TF | ≥ 200 | 3.0dBi Typ. | 1.0dBi Typ. | < 2 | 50 | 3 |

※Frequency will be changed with layout of PCB. Please contact us for appropriate design.

RETURN LOSS

SLDA21-2R450G-S1TF

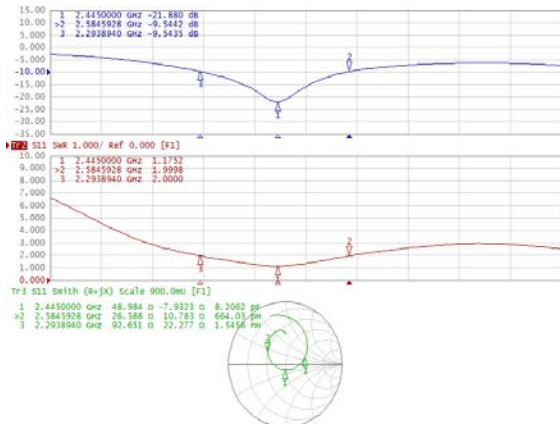

SLDA31-2R800G-S1TF

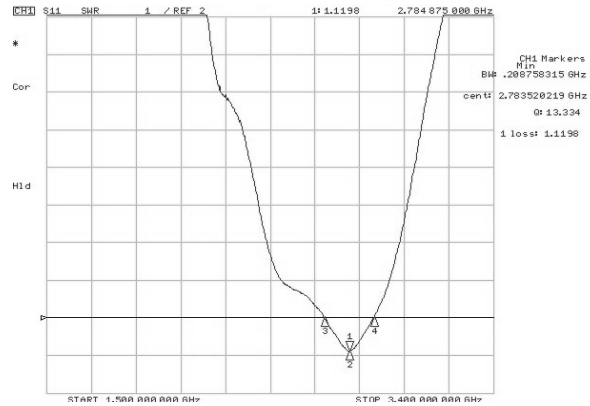

SLDA31-2R400G-S1TF

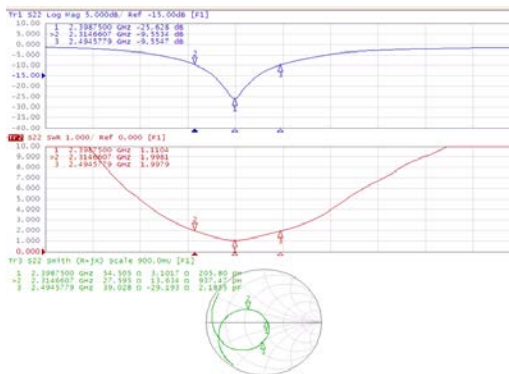

SLDA31-2R450G-S2TF

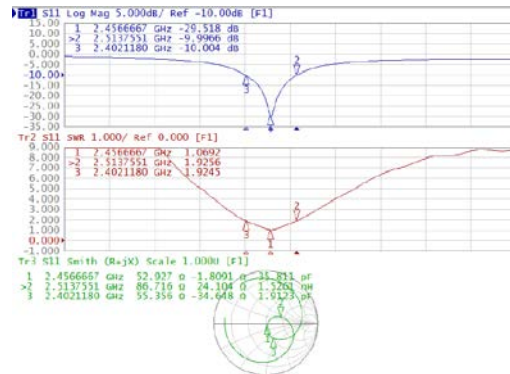

SLDA52-2R510G-S1TF

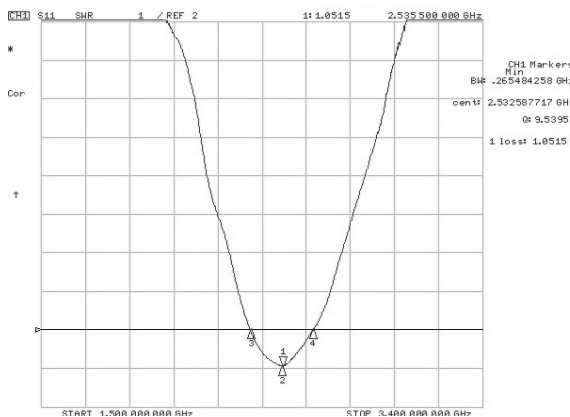

SLDA52-2R540G-S1TF

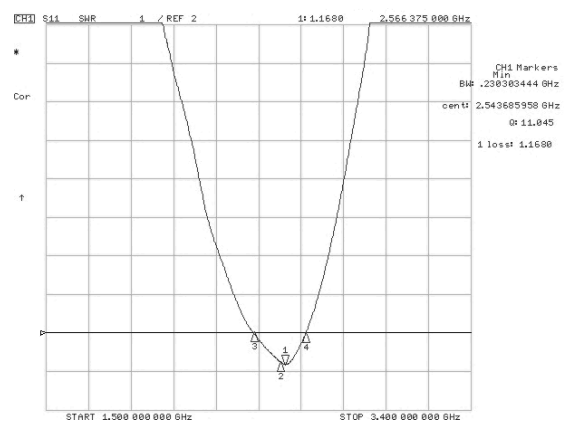

RETURN LOSS

SLDA62-2R640G-01TF

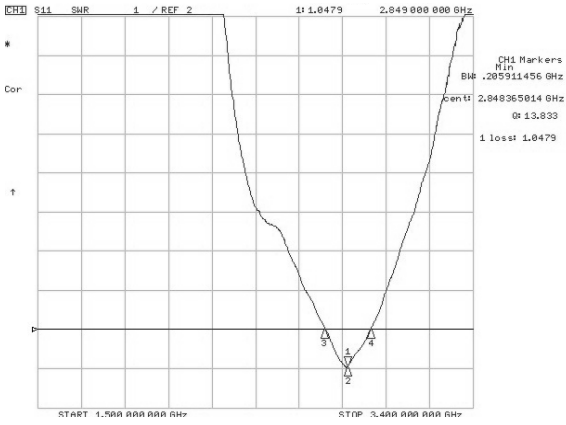

SLDA72-2R470G-S1TF

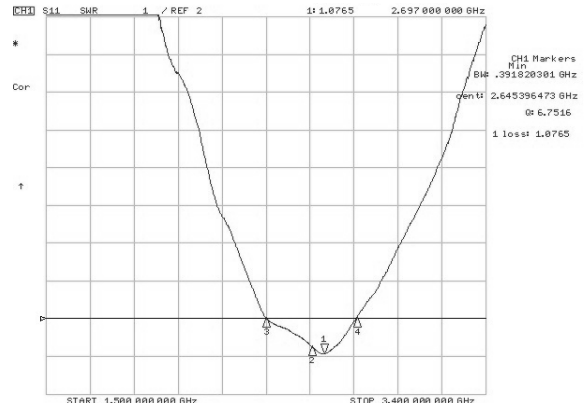

SLDA81-3R010G-S1TF

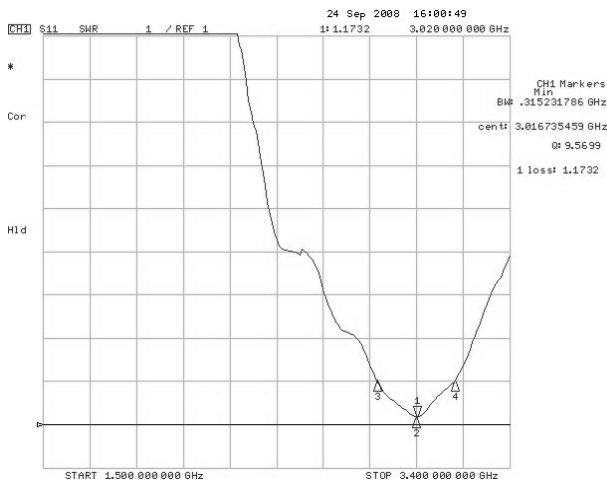

SLDA92-2R660G-S1TF

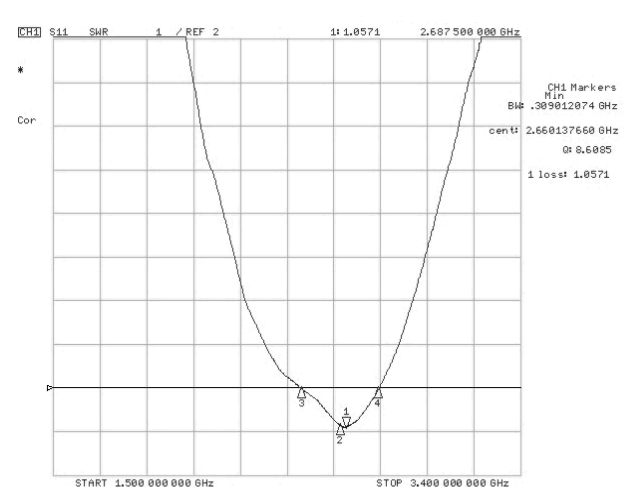

X-ON Electronics

Largest Supplier of Electrical and Electronic Components

Click to view similar products for [Antennas](#) category:

Click to view products by [Sunlord](#) manufacturer:

Other Similar products are found below :

[CCT FM1](#) [ABFT](#) [AD-NM-SMAF 001-0021](#) [CTC110](#) [MAF94149](#) [EXE902SF](#) [MMCX-SMA-100](#) [PDQ24496-91NF](#) [GAN30084EU](#) [930-033-R](#) [A08-HABUF-P5I](#) [AAF95035](#) [DG-ANT-20DP-BG-B](#) [APAMPGJ-141](#) [1513563-1](#) [OF86315-FNF](#) [OP24516DS-91NM](#) [A09-HASM-7](#) [EXE902MD](#) [EXE902SM](#) [SPDA17806/2170LAR](#) [APAMPG-117](#) [GPS1575SP26-004](#) [GPS15MGSMA](#) [CMD69273P-30NF](#) [CMQ69273-30NF](#) [RD2458-5-OTDR-NM](#) [RD2458-5-RSMA](#) [TRAB24/49003](#) [W4120ER5000](#) [W6102B0100](#) [YE572113-30RSMM](#) [108-00014-50](#) [SPDA17RP918](#) [OP24516SX-91NM](#) [OP24516SX-91RSMM](#) [CMQ69273P-30NF](#) [CMS69273-30NF](#) [CMS69273P-30NF](#) [TRAB24003N](#) [TRAB24003NP](#) [TRAB8213NP](#) [TRAB8903](#) [A09-Y8NF](#) [A09-Y11NF](#) [A09-HSM-7](#) [A09-F8NF-M](#) [A09-F5NF-M](#)