

Wire Wound SMD Power Inductors – SPH Series

Operating Temp. : -40°C~+125°C (Including self-heating)

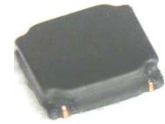

FEATURES

- Magnetic-resin shielded construction reduces buzz noise to ultra-low levels
- Metallization on ferrite core results in excellent shock resistance and damage-free durability
- Closed magnetic circuit design reduces leakage flux and Electro Magnetic Interference (EMI)
- Takes up less PCB real estate and save more power
- 30% lower DCR than SWPA series and larger current

APPLICATIONS

- Smart phone
- Blue -ray disc recorders, set top box
- Notebooks, desktop computers, servers
- Portable gaming devices, personal navigation systems, personal multimedia devices

PRODUCT IDENTIFICATION

SPH 252012 H 2R2 M T □□□
 ① ② ③ ④ ⑤ ⑥ ⑦

① Type	
SPH	Wire Wound SMD Power Inductor

③ Material Code	
U	U Type Material
H	H Type Material

④ Nominal Inductance	
Example	Nominal Value
R47	0.47μH
2R2	2.2μH

⑤ Inductance Tolerance	
M	±20%

⑥ Packing	
T	Tape & Reel

② External Dimensions (L×W×H) [mm]	
201610	2.0×1.6×1.0
202012	2.0×2.0×1.2
252010	2.5×2.0×1.0
252012	2.5×2.0×1.2
3012	3.0×3.0×1.2
3015	3.0×3.0×1.5
4012	4.0×4.0×1.2
4018	4.0×4.0×1.8
4020	4.0×4.0×2.0
4030	4.0×4.0×3.0
8030	8.0×8.0×3.0

⑦ Design Code	
□□□	Design Code
* Standard product is blank	

SHAPE AND DIMENSIONS

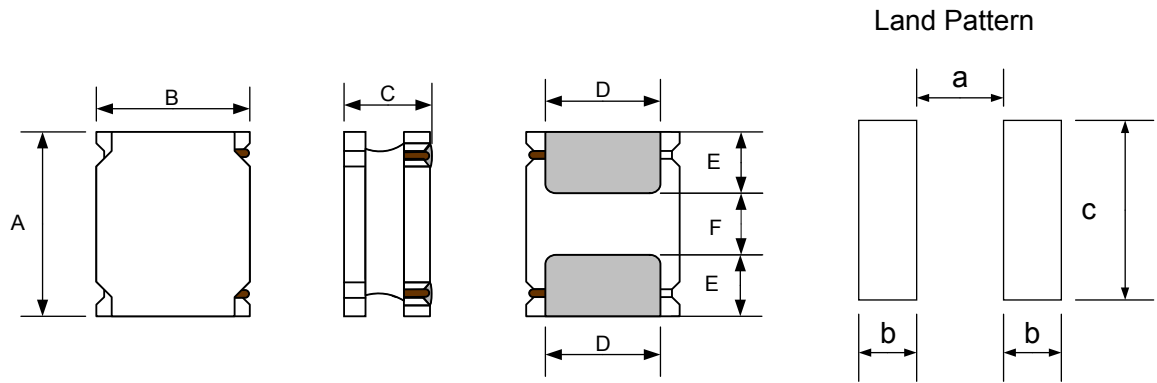

Unit: mm

Series	A	B	C	D	E	F	a Typ.	b Typ.	c Typ.
SPH201610	2.0±0.2	1.6±0.2	1.0 Max.	1.60±0.2	0.60±0.2	0.80±0.2	0.70	0.70	1.7
SPH202012	2.0±0.1	2.0±0.1	1.2 Max.	1.60±0.2	0.60±0.2	0.80±0.2	0.65	0.70	2.0
SPH252010	2.5±0.2	2.0±0.2	1.0 Max.	2.00±0.2	0.80±0.2	0.80±0.2	0.80	0.85	2.0
SPH252012	2.5±0.2	2.0±0.2	1.2 Max.	2.00±0.2	0.80±0.2	0.80±0.2	0.80	0.85	2.0
SPH3012	3.0±0.2	3.0±0.2	1.2 Max.	2.5±0.2	0.75±0.2	1.5±0.2	1.5	0.8	2.7
SPH3015	3.0±0.2	3.0±0.2	1.5 Max.	2.5±0.2	0.75±0.2	1.5±0.2	1.5	0.8	2.7
SPH4012	4.0±0.2	4.0±0.2	1.2 Max.	3.3±0.2	0.95±0.2	2.1±0.2	1.9	1.1	3.7
SPH4018	4.0±0.2	4.0±0.2	1.8 Max.	3.3±0.2	0.95±0.2	2.1±0.2	1.9	1.1	3.7
SPH4020	4.0±0.2	4.0±0.2	2.0 Max.	3.3±0.2	0.95±0.2	2.1±0.2	1.9	1.1	3.7
SPH4030	4.0±0.2	4.0±0.2	3.0 Max.	3.3±0.2	0.95±0.2	2.1±0.2	1.9	1.1	3.7
SPH8030	8.0±0.3	8.0±0.3	3.0 Max.	6.3±0.3	2.00±0.3	4.0±0.3	3.0	2.2	7.5

SPECIFICATIONS

SPH201610H Series

Part Number	Inductance	DC Resistance		Saturation Current		Heat Rating Current	
	@1MHz,1V	Max.	Typ.	Max.	Typ.	Max.	Typ.
Units	μH	Ω		A		A	
Symbol	L	DCR		Isat		I _{rms}	
SPH201610HR16MT	0.16±20%	0.031	0.026	4.30	4.80	3.20	3.50
SPH201610HR24MT	0.24±20%	0.040	0.033	3.70	4.10	2.90	3.20
SPH201610HR33MT	0.33±20%	0.040	0.033	2.50	3.10	2.90	3.20
SPH201610HR47MT	0.47±20%	0.059	0.049	2.30	2.85	2.35	2.60
SPH201610HR68MT	0.68±20%	0.076	0.063	1.95	2.45	2.05	2.25
SPH201610H1R0MT	1.0±20%	0.114	0.095	1.65	1.85	1.45	1.60
SPH201610H1R5MT	1.5±20%	0.174	0.145	1.35	1.65	1.25	1.40
SPH201610H2R2MT	2.2±20%	0.264	0.220	1.20	1.45	1.10	1.20
SPH201610H3R3MT	3.3±20%	0.335	0.279	0.90	1.05	0.88	0.98
SPH201610H4R7MT	4.7±20%	0.479	0.399	0.70	0.85	0.74	0.82
SPH201610H6R8MT	6.8±20%	0.816	0.680	0.60	0.70	0.52	0.58
SPH201610H100MT	10±20%	1.020	0.850	0.50	0.55	0.45	0.50

SPECIFICATIONS

SPH201610U Series

Part Number	Inductance	DC Resistance		Saturation Current		Heat Rating Current	
	@1MHz, 1V	Max.	Typ.	Max.	Typ.	Max.	Typ.
Units	μH	Ω		A		A	
Symbol	L	DCR		Isat		Irms	
SPH201610U50NMT	0.05±20%	0.022	0.018	7.50	8.00	3.65	4.25
SPH201610UR10MT	0.10±20%	0.022	0.018	4.80	5.70	3.65	4.25
SPH201610UR16MT	0.16±20%	0.031	0.026	4.70	5.40	3.20	3.50
SPH201610UR24MT	0.24±20%	0.040	0.033	4.50	5.00	2.90	3.20
SPH201610UR33MT	0.33±20%	0.040	0.033	3.00	3.60	2.90	3.20
SPH201610UR47MT	0.47±20%	0.052	0.043	2.90	3.40	2.35	2.60
SPH201610UR47MTY01	0.47±20%	0.045	0.037	2.50	2.90	2.75	3.00
SPH201610UR68MT	0.68±20%	0.072	0.060	2.50	2.70	2.05	2.25
SPH201610U1R0MT	1.0±20%	0.072	0.060	1.30	1.50	2.05	2.25
SPH201610U2R2MT	2.2±20%	0.171	0.143	1.10	1.20	1.23	1.40

SPH202012H Series

Part Number	Inductance	DC Resistance		Saturation Current		Heat Rating Current	
	@1MHz, 1V	Max.	Typ.	Max.	Typ.	Max.	Typ.
Units	μH	Ω		A		A	
Symbol	L	DCR		Isat		Irms	
SPH202012HR16MT	0.16±20%	0.031	0.026	5.20	5.80	2.50	2.75
SPH202012HR24MT	0.24±20%	0.042	0.035	4.70	5.20	2.20	2.40
SPH202012HR33MT	0.33±20%	0.042	0.035	3.50	4.00	2.20	2.40
SPH202012HR47MT	0.47±20%	0.050	0.042	3.55	3.75	2.00	2.20
SPH202012HR68MT	0.68±20%	0.060	0.050	2.95	3.10	1.80	2.00
SPH202012H1R0MT	1.0±20%	0.088	0.073	2.70	2.85	1.50	1.65
SPH202012H1R5MT	1.5±20%	0.112	0.093	2.00	2.20	1.30	1.45
SPH202012H2R2MT	2.2±20%	0.127	0.106	1.40	1.65	1.20	1.35
SPH202012H3R3MT	3.3±20%	0.276	0.230	1.20	1.35	0.85	0.95
SPH202012H4R7MT	4.7±20%	0.294	0.245	0.97	1.10	0.82	0.90
SPH202012H6R8MT	6.8±20%	0.479	0.399	0.82	0.92	0.64	0.70
SPH202012H100MT	10±20%	0.785	0.654	0.72	0.82	0.49	0.54
SPH202012H150MT	15±20%	1.368	1.140	0.55	0.65	0.38	0.42
SPH202012H180MT	18±20%	1.680	1.400	0.60	0.68	0.35	0.38
SPH202012H220MT	22±20%	1.680	1.400	0.40	0.50	0.35	0.38
SPH202012H330MT	33±20%	2.160	1.800	0.35	0.40	0.30	0.33

SPH252010H Series

Part Number	Inductance	DC Resistance		Saturation Current		Heat Rating Current	
	@1MHz, 1V	Max.	Typ.	Max.	Typ.	Max.	Typ.
Units	μH	Ω		A		A	
Symbol	L	DCR		Isat		Irms	
SPH252010HR24MT	0.24±20%	0.034	0.028	3.60	4.40	2.75	3.00
SPH252010HR33MT	0.33±20%	0.043	0.036	3.80	4.60	2.40	2.65
SPH252010HR47MT	0.47±20%	0.044	0.037	2.40	2.80	2.40	2.65
SPH252010HR68MT	0.68±20%	0.061	0.051	2.75	3.10	2.10	2.35
SPH252010HR68MTY01	0.68±20%	0.061	0.051	2.75	3.10	2.10	2.35
SPH252010HR68MTY02	0.68±20%	0.065	0.055	3.20	3.50	2.10	2.30
SPH252010H1R0MT	1.0±20%	0.080	0.067	2.05	2.45	1.80	2.00
SPH252010H1R5MT	1.5±20%	0.108	0.090	1.70	2.05	1.55	1.70
SPH252010H2R2MT	2.2±20%	0.137	0.114	1.55	1.80	1.40	1.55
SPH252010H3R3MT	3.3±20%	0.228	0.170	1.10	1.40	1.10	1.20
SPH252010H4R7MT	4.7±20%	0.323	0.269	1.00	1.15	0.91	1.00

SPECIFICATIONS

SPH252010H Series

Part Number	Inductance	DC Resistance		Saturation Current		Heat Rating Current	
	@1MHz,1V	Max.	Typ.	Max.	Typ.	Max.	Typ.
Units	μH	Ω		A		A	
Symbol	L	DCR		Isat		Irms	
SPH252010H6R8MT	6.8±20%	0.451	0.376	0.82	0.95	0.76	0.84
SPH252010H100MT	10±20%	0.584	0.487	0.65	0.75	0.67	0.74
SPH252010H150MT	15±20%	0.954	0.795	0.55	0.65	0.50	0.55
SPH252010H220MT	22±20%	1.548	1.290	0.45	0.55	0.40	0.45
SPH252010H330MT	33±20%	1.548	1.290	0.25	0.30	0.40	0.45

SPH252012H Series

Part Number	Inductance	DC Resistance		Saturation Current		Heat Rating Current	
	@1MHz,1V	Max.	Typ.	Max.	Typ.	Max.	Typ.
Units	μH	Ω		A		A	
Symbol	L	DCR		Isat		Irms	
SPH252012HR16MT	0.16±20%	0.022	0.018	6.50	7.20	4.05	4.50
SPH252012HR24MT	0.24±20%	0.022	0.018	4.00	4.75	4.05	4.50
SPH252012HR33MT	0.33±20%	0.029	0.024	4.00	4.70	3.35	3.70
SPH252012HR47MT	0.47±20%	0.036	0.030	3.70	4.10	3.00	3.30
SPH252012HR47MTY01	0.47±20%	0.038	0.032	4.90	5.20	2.90	3.20
SPH252012HR68MT	0.68±20%	0.061	0.051	3.00	3.30	2.10	2.30
SPH252012HR68MTY01	0.68±20%	0.042	0.035	3.20	3.50	2.50	2.70
SPH252012HR68MTY02	0.68±20%	0.060	0.051	3.80	4.20	2.10	2.30
SPH252012H1R0MT	1.0±20%	0.044	0.037	1.70	1.90	2.20	2.40
SPH252012H1R0MTY03	1.0±20%	0.043	0.037	2.40	2.60	2.40	2.60
SPH252012H1R2MT	1.2±20%	0.078	0.065	2.20	2.50	1.95	2.10
SPH252012H1R5MT	1.5±20%	0.078	0.065	2.00	2.35	1.95	2.10
SPH252012H2R2MT	2.2±20%	0.096	0.080	1.80	1.95	1.80	1.95
SPH252012H3R3MT	3.3±20%	0.144	0.120	1.15	1.25	1.40	1.50
SPH252012H4R7MT	4.7±20%	0.210	0.175	1.10	1.20	1.12	1.25
SPH252012H6R8MT	6.8±20%	0.360	0.300	0.80	1.00	0.95	1.05
SPH252012H100MT	10±20%	0.522	0.435	0.70	0.85	0.79	0.87
SPH252012H150MT	15±20%	1.000	0.830	0.65	0.75	0.57	0.63
SPH252012H180MT	18±20%	1.000	0.830	0.50	0.65	0.57	0.63
SPH252012H220MT	22±20%	1.090	0.910	0.45	0.55	0.54	0.60
SPH252012H330MT	33±20%	1.840	1.530	0.35	0.40	0.42	0.46
SPH252012H470MT	47±20%	2.220	1.850	0.25	0.30	0.30	0.35

SPH3012H Series

Part Number	Inductance	DC Resistance		Saturation Current		Heat Rating Current	
	@1MHz,1V	Max.	Typ.	Max.	Typ.	Max.	Typ.
Units	μH	Ω		A		A	
Symbol	L	DCR		Isat		Irms	
SPH3012H1R0MT	1.0±20%	0.040	0.032	2.20	2.50	2.30	2.50
SPH3012H1R0MTY02	1.0±20%	0.056	0.047	2.80	3.20	1.90	2.00
SPH3012H2R2MT	2.2±20%	0.090	0.075	1.50	1.80	1.40	1.60
SPH3012H3R3MT	3.3±20%	0.134	0.112	1.23	1.55	1.40	1.60
SPH3012H100MT	10±20%	0.372	0.310	0.75	0.90	0.75	0.80
SPH3012H100MTY01	10±20%	0.495	0.413	1.00	1.10	0.90	1.00
SPH3012H220MT	22±20%	0.840	0.700	0.50	0.60	0.50	0.55

SPECIFICATIONS

SPH3015H Series

Part Number	Inductance	DC Resistance		Saturation Current		Heat Rating Current	
	@1MHz, 1V	Max.	Typ.	Max.	Typ.	Max.	Typ.
Units	μH	Ω		A		A	
Symbol	L	DCR		Isat		Irms	
SPH3015HR22MT	0.22±20%	0.022	0.018	6.00	6.80	3.00	3.50
SPH3015HR24MT	0.24±20%	0.022	0.018	5.50	5.50	3.00	3.50
SPH3015HR47MT	0.47±20%	0.022	0.018	2.40	2.80	3.00	3.50
SPH3015HR55MT	0.55±20%	0.019	0.016	2.40	2.70	3.05	3.55
SPH3015H1R0MT	1.0±20%	0.040	0.033	2.70	3.00	2.20	2.50
SPH3015H1R5MT	1.5±20%	0.048	0.040	2.00	2.30	2.00	2.30
SPH3015H2R2MT	2.2±20%	0.060	0.050	1.50	1.70	1.80	2.05
SPH3015H3R3MT	3.3±20%	0.084	0.070	1.30	1.50	1.50	1.70
SPH3015H3R9MT	3.9±20%	0.115	0.096	1.30	1.60	1.30	1.50
SPH3015H4R7MT	4.7±20%	0.115	0.096	1.10	1.20	1.30	1.50
SPH3015H6R8MT	6.8±20%	0.144	0.120	0.80	0.90	1.16	1.35
SPH3015H100MT	10±20%	0.276	0.230	0.75	0.90	0.84	0.97
SPH3015H150MT	15±20%	0.360	0.300	0.60	0.70	0.73	0.84
SPH3015H220MT	22±20%	0.540	0.450	0.52	0.60	0.60	0.70
SPH3015H260MT	26±20%	0.768	0.640	0.40	0.50	0.45	0.55
SPH3015H330MT	33±20%	1.090	0.910	0.50	0.55	0.50	0.55
SPH3015H470MT	47±20%	1.250	1.040	0.35	0.42	0.45	0.50

SPH4012H Series

Part Number	Inductance	DC Resistance		Saturation Current		Heat Rating Current	
	@0.1MHz, 1V	Max.	Typ.	Max.	Typ.	Max.	Typ.
Units	μH	Ω		A		A	
Symbol	L	DCR		Isat		Irms	
SPH4012HR33NT	0.33±30%	0.031	0.026	5.50	6.30	2.90	3.35
SPH4012HR47NT	0.47±30%	0.032	0.027	3.50	4.20	2.90	3.20
SPH4012HR82NT	0.82±30%	0.042	0.035	3.00	3.50	2.50	2.90
SPH4012H1R0NT	1.0±30%	0.050	0.042	2.80	3.30	2.20	2.50
SPH4012H1R5NT	1.5±30%	0.050	0.042	2.10	2.20	2.20	2.50
SPH4012H1R8NT	1.8±30%	0.066	0.055	2.10	2.40	2.00	2.30
SPH4012H2R2MT	2.2±20%	0.066	0.055	1.70	1.80	2.00	2.30
SPH4012H2R7MT	2.7±20%	0.084	0.070	1.90	2.20	1.70	2.00
SPH4012H3R3MT	3.3±20%	0.084	0.070	1.40	1.70	1.70	2.00
SPH4012H3R6MT	3.6±20%	0.090	0.075	1.20	1.60	1.70	2.00
SPH4012H4R3MT	4.3±20%	0.108	0.090	1.20	1.50	1.50	1.80
SPH4012H4R7MT	4.7±20%	0.108	0.090	1.20	1.30	1.50	1.80
SPH4012H5R1MT	5.1±20%	0.132	0.110	1.20	1.40	1.40	1.60
SPH4012H5R6MT	5.6±20%	0.132	0.110	1.10	1.40	1.40	1.60
SPH4012H6R8MT	6.8±20%	0.150	0.125	0.90	1.10	1.30	1.60
SPH4012H100MT	10±20%	0.204	0.170	0.80	0.90	1.10	1.30
SPH4012H100MTY01	10±20%	0.240	0.200	0.90	1.10	1.00	1.10
SPH4012H120MT	12±20%	0.312	0.260	0.85	1.00	0.90	1.00
SPH4012H150MT	15±20%	0.312	0.260	0.65	0.80	0.90	1.00
SPH4012H180MT	18±20%	0.432	0.360	0.65	0.80	0.78	0.90
SPH4012H220MT	22±20%	0.460	0.380	0.50	0.65	0.78	0.90
SPH4012H270MT	27±20%	0.672	0.560	0.50	0.60	0.63	0.73
SPH4012H330MT	33±20%	0.756	0.630	0.45	0.55	0.57	0.68
SPH4012H360MT	36±20%	0.756	0.630	0.40	0.50	0.57	0.68
SPH4012H390MT	39±20%	1.188	0.990	0.55	0.62	0.47	0.54

SPECIFICATIONS

SPH4012H Series

Part Number	Inductance	DC Resistance		Saturation Current		Heat Rating Current	
	@0.1MHz,1V	Max.	Typ.	Max.	Typ.	Max.	Typ.
Units	μH	Ω		A		A	
Symbol	L	DCR		Isat		Irms	
SPH4012H470MT	47±20%	1.188	0.990	0.40	0.50	0.47	0.54
SPH4012H560MT	56±20%	1.320	1.100	0.35	0.45	0.45	0.52
SPH4012H680MT	68±20%	1.800	1.500	0.38	0.45	0.38	0.44
SPH4012H820MT	82±20%	2.040	1.700	0.30	0.38	0.36	0.42
SPH4012H101MT	100±20%	2.040	1.700	0.25	0.31	0.36	0.42

SPH4018H Series

Part Number	Inductance	DC Resistance		Saturation Current		Heat Rating Current	
	@0.1MHz,1V	Max.	Typ.	Max.	Typ.	Max.	Typ.
Units	μH	Ω		A		A	
Symbol	L	DCR		Isat		Irms	
SPH4018HR33NT	0.33±30%	0.016	0.012	6.50	8.00	4.20	4.70
SPH4018HR47NT	0.47±30%	0.020	0.017	6.50	7.20	3.50	4.00
SPH4018H1R0NT	1.0±30%	0.032	0.027	4.00	4.80	3.20	3.70
SPH4018H1R5NT	1.5±30%	0.037	0.031	3.60	4.30	2.95	3.30
SPH4018H2R2MT	2.2±20%	0.050	0.042	3.00	3.40	2.20	2.90
SPH4018H3R3MT	3.3±20%	0.066	0.055	2.30	2.90	2.00	2.50
SPH4018H4R7MT	4.7±20%	0.084	0.070	2.00	2.20	1.70	2.10
SPH4018H6R8MT	6.8±20%	0.118	0.098	1.60	1.80	1.45	1.70
SPH4018H100MT	10±20%	0.180	0.150	1.30	1.50	1.20	1.50
SPH4018H150MT	15±20%	0.252	0.210	1.10	1.20	0.85	1.20
SPH4018H220MT	22±20%	0.348	0.290	0.90	1.10	0.70	1.00
SPH4018H330MT	33±20%	0.552	0.460	0.70	0.90	0.55	0.82
SPH4018H470MT	47±20%	0.744	0.620	0.57	0.70	0.91	1.01
SPH4018H680MT	68±20%	0.972	0.810	0.53	0.62	0.68	0.73
SPH4018H101MT	100±20%	1.560	1.300	0.49	0.57	0.40	0.47
SPH4018H151MT	150±20%	3.120	2.600	0.41	0.47	0.28	0.33
SPH4018H221MT	220±20%	3.840	3.200	0.33	0.38	0.25	0.29
SPH4018H331MT	330±20%	5.880	4.900	0.26	0.31	0.20	0.23

SPH4020H Series

Part Number	Inductance	DC Resistance		Saturation Current		Heat Rating Current	
	@0.1MHz,1V	Max.	Typ.	Max.	Typ.	Max.	Typ.
Units	μH	Ω		A		A	
Symbol	L	DCR		Isat		Irms	
SPH4020HR33NT	0.33±30%	0.016	0.013	7.50	8.50	3.30	4.90

SPH4030H Series

Part Number	Inductance	DC Resistance		Saturation Current		Heat Rating Current	
	@0.1MHz,1V	Max.	Typ.	Max.	Typ.	Max.	Typ.
Units	μH	Ω		A		A	
Symbol	L	DCR		Isat		Irms	
SPH4030HR10NT	0.10±30%	0.005	0.006	17.00	18.50	4.60	6.30
SPH4030HR22NT	0.22±30%	0.007	0.006	11.50	12.50	3.90	5.20
SPH4030HR47NT	0.47±30%	0.013	0.011	8.20	9.20	4.50	5.20

SPECIFICATIONS

SPH8030H Series

Part Number	Inductance	DC Resistance		Saturation Current		Heat Rating Current	
	@0.1MHz,1V	Max.	Typ.	Max.	Typ.	Max.	Typ.
Units	μH	Ω		A		A	
Symbol	L	DCR		Isat		I _{rms}	
SPH8030H1R0NT	1.0±30%	0.012	0.009	7.80	9.00	6.20	7.30
SPH8030H1R5NT	1.5±30%	0.016	0.012	6.20	7.60	5.30	6.20
SPH8030H2R2MT	2.2±20%	0.020	0.015	4.90	6.30	4.80	5.70
SPH8030H3R3MT	3.3±20%	0.025	0.019	4.20	5.10	4.30	5.10
SPH8030H4R7MT	4.7±20%	0.029	0.022	3.60	4.30	4.00	4.70
SPH8030H6R8MT	6.8±20%	0.038	0.029	3.00	3.50	3.40	3.90
SPH8030H100MT	10±20%	0.043	0.033	2.40	2.80	3.00	3.70
SPH8030H150MT	15±20%	0.078	0.060	2.00	2.40	2.20	2.80
SPH8030H220MT	22±20%	0.091	0.070	1.75	2.00	1.90	2.40
SPH8030H330MT	33±20%	0.156	0.120	1.30	1.70	1.50	2.10
SPH8030H470MT	47±20%	0.221	0.170	1.10	1.40	1.30	1.70

※1 : All test data is referenced to 20°C ambient;

※2 : Rated current: Isat or I_{rms}, whichever is smaller;

※Isat: DC current at which the inductance drops approximate 30% from its value without current;

※I_{rms}: DC current that causes the temperature rise ($\Delta T = 40^\circ\text{C}$) from 20°C ambient.

TYPICAL ELECTRICAL CHARACTERISTICS

SPH201610H Series

Temperature vs. DC Current Characteristics

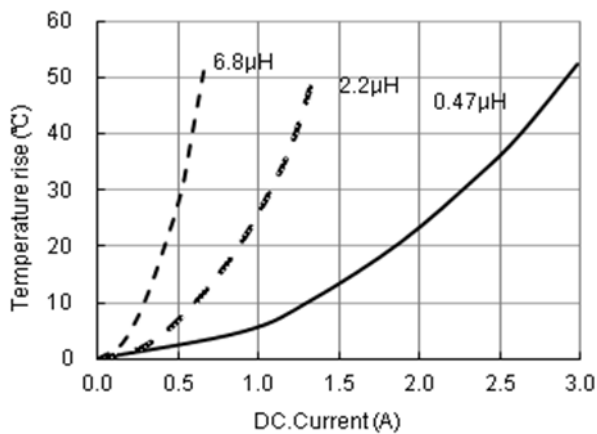

Inductance vs. DC Current Characteristics

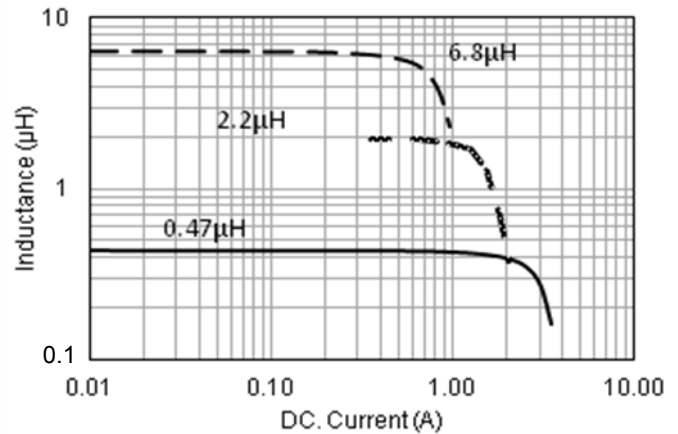

SPH202012H Series

Temperature vs. DC Current Characteristics

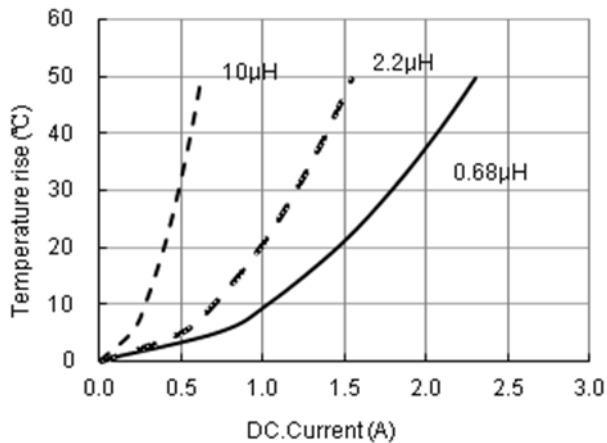

Inductance vs. DC Current Characteristics

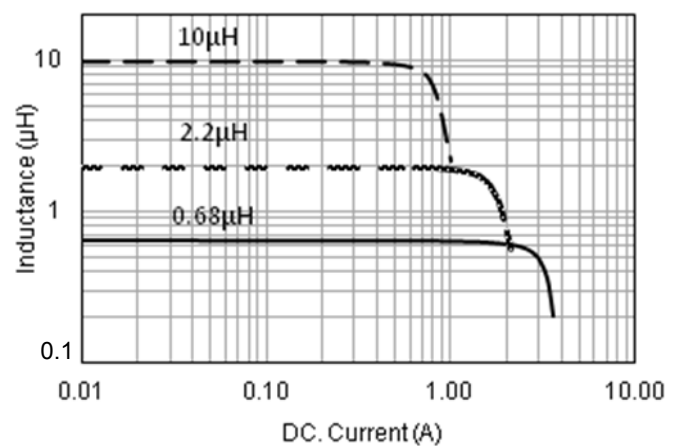

TYPICAL ELECTRICAL CHARACTERISTICS

SPH252010H Series

Temperature vs. DC Current Characteristics



Inductance vs. DC Current Characteristics



SPH252012H Series

Temperature vs. DC Current Characteristics



Inductance vs. DC Current Characteristics

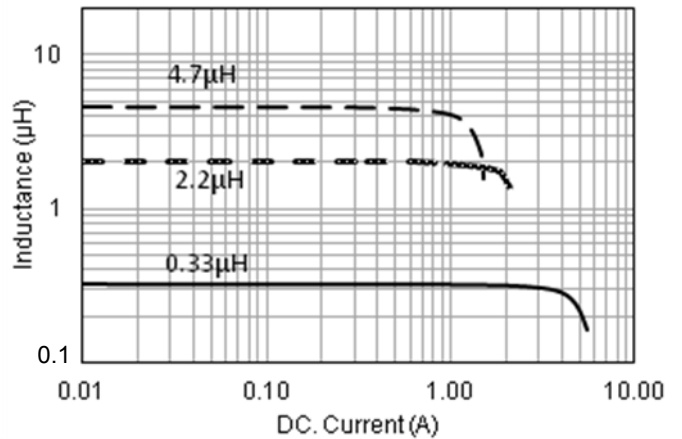

SPH3012H Series

Temperature vs. DC Current Characteristics



Inductance vs. DC Current Characteristics

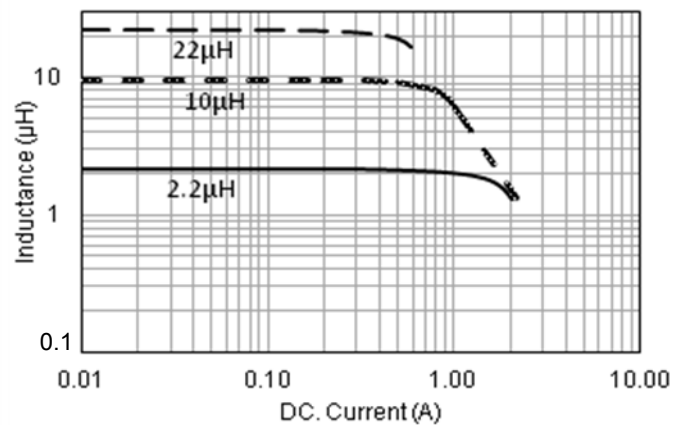

TYPICAL ELECTRICAL CHARACTERISTICS

SPH3015H Series

Temperature vs. DC Current Characteristics

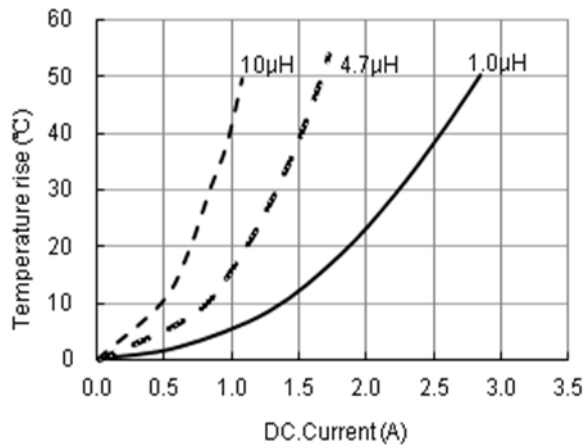

Inductance vs. DC Current Characteristics



SPH4012H Series

Temperature vs. DC Current Characteristics

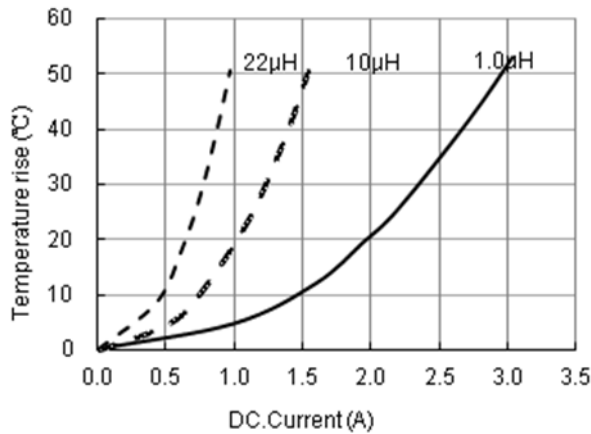

Inductance vs. DC Current Characteristics



SPH4018H Series

Temperature vs. DC Current Characteristics

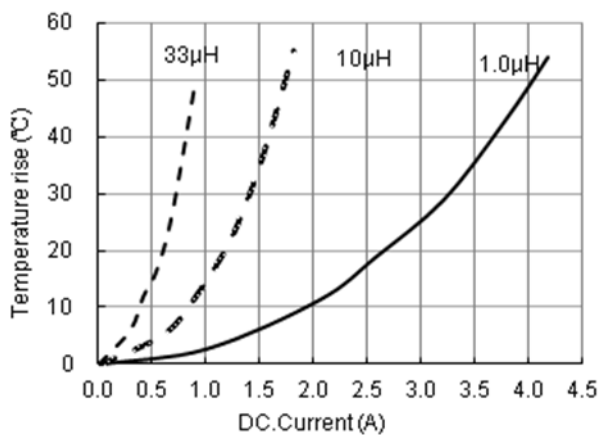

Inductance vs. DC Current Characteristics



TYPICAL ELECTRICAL CHARACTERISTICS

SPH4020H Series

Temperature vs. DC Current Characteristics

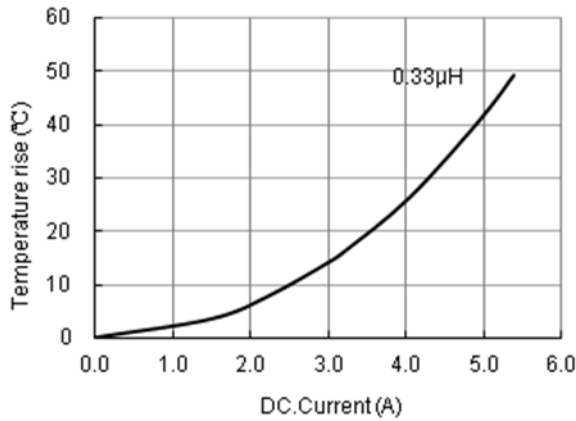

Inductance vs. DC Current Characteristics



SPH4030H Series

Temperature vs. DC Current Characteristics

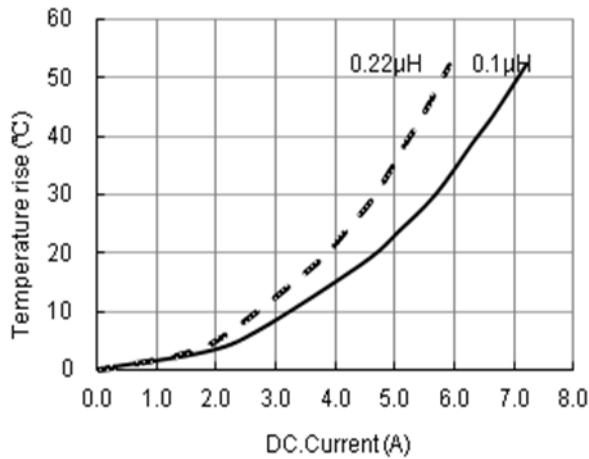

Inductance vs. DC Current Characteristics



SPH8030H Series

Temperature vs. DC Current Characteristics

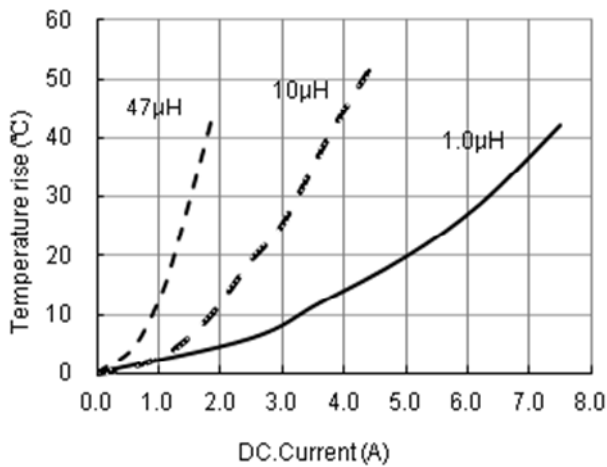

Inductance vs. DC Current Characteristics

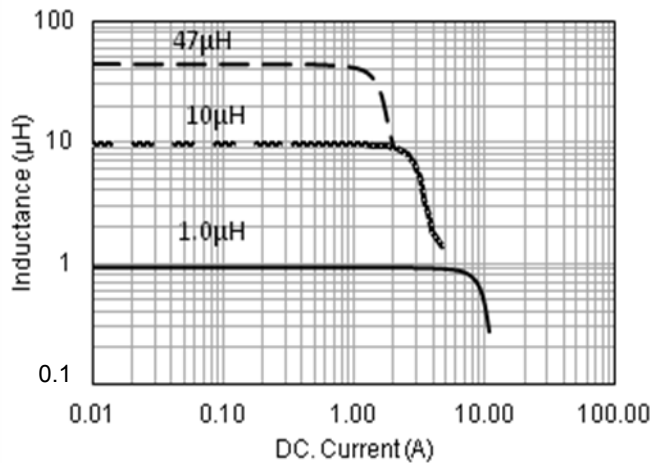

X-ON Electronics

Largest Supplier of Electrical and Electronic Components

Click to view similar products for [Fixed Inductors](#) category:

Click to view products by [Sunlord](#) manufacturer:

Other Similar products are found below :

[CR32NP-100KC](#) [CR32NP-151KC](#) [CR32NP-180KC](#) [CR32NP-181KC](#) [CR32NP-1R5MC](#) [CR32NP-390KC](#) [CR32NP-3R9MC](#) [CR32NP-680KC](#) [CR32NP-820KC](#) [CR32NP-8R2MC](#) [CR43NP-390KC](#) [CR43NP-560KC](#) [CR43NP-680KC](#) [CR54NP-181KC](#) [CR54NP-470LC](#) [CR54NP-820KC](#) [CR54NP-8R5MC](#) [70F224AI](#) [MGDQ4-00004-P](#) [MHL1ECTTP18NJ](#) [MHQ1005P10NJ](#) [MHQ1005P1N0S](#) [MHQ1005P2N4S](#) [MHQ1005P3N6S](#) [MHQ1005P5N1S](#) [MHQ1005P8N2J](#) [PE-51506NL](#) [PE-53601NL](#) [PE-53602NL](#) [PE-53630NL](#) [PE-53824SNLT](#) [PE-92100NL](#) [PG0434.801NLT](#) [PG0936.113NLT](#) [9220-20](#) [9310-16](#) [PM06-2N7](#) [PM06-39NJ](#) [A01TK](#) [1206CS-471XJ](#) [HC2LP-R47-R](#) [HC2-R47-R](#) [HC3-2R2-R](#) [HCF1305-3R3-R](#) [1206CS-151XG](#) [RCH664NP-140L](#) [RCH664NP-4R7M](#) [RCH8011NP-221L](#) [RCP1317NP-332L](#) [RCP1317NP-391L](#)