

Wire Wound SMD Power Inductors – SPH Series

Operating Temp. : -40°C~+125°C (Including self-heating)



FEATURES

- Magnetic-resin shielded construction reduces buzz noise to ultra-low levels
- Metallization on ferrite core results in excellent shock resistance and damage-free durability
- Closed magnetic circuit design reduces leakage flux and Electro Magnetic Interference (EMI)
- Takes up less PCB real estate and save more power
- 30% lower DCR than SWPA series and larger current

APPLICATIONS

- Smart phone
- Blue -ray disc recorders, set top box
- Notebooks, desktop computers, servers
- Portable gaming devices, personal navigation systems, personal multimedia devices

PRODUCT IDENTIFICATION

SPH

①

252012

②

H

③

2R2

④

M

⑤

T

⑥

□□□

⑦

| ① Type | |
|--------|-------------------------------|
| SPH | Wire Wound SMD Power Inductor |

| ③ Material Code | |
|-----------------|-----------------|
| U | U Type Material |
| H | H Type Material |

| ④ Nominal Inductance | |
|----------------------|---------------|
| Example | Nominal Value |
| R47 | 0.47μH |
| 2R2 | 2.2μH |

| ⑤ Inductance Tolerance | |
|------------------------|------|
| M | ±20% |

| ⑥ Packing | |
|-----------|-------------|
| T | Tape & Reel |

| ② External Dimensions (L×W×H) [mm] | |
|------------------------------------|-------------|
| 201610 | 2.0×1.6×1.0 |
| 202012 | 2.0×2.0×1.2 |
| 252010 | 2.5×2.0×1.0 |
| 252012 | 2.5×2.0×1.2 |
| 3012 | 3.0×3.0×1.2 |
| 3015 | 3.0×3.0×1.5 |
| 4012 | 4.0×4.0×1.2 |
| 4018 | 4.0×4.0×1.8 |
| 4020 | 4.0×4.0×2.0 |
| 4030 | 4.0×4.0×3.0 |
| 8030 | 8.0×8.0×3.0 |

| ⑦ Design Code | |
|-----------------------------|-------------|
| □□□ | Design Code |
| * Standard product is blank | |

SHAPE AND DIMENSIONS

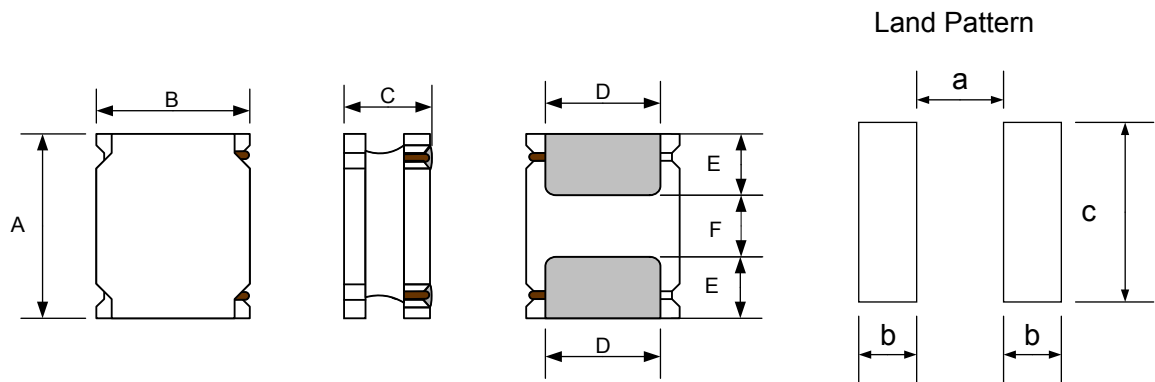

Unit: mm

| Series | A | B | C | D | E | F | a Typ. | b Typ. | c Typ. |
|-----------|---------|---------|----------|----------|----------|----------|--------|--------|--------|
| SPH201610 | 2.0±0.2 | 1.6±0.2 | 1.0 Max. | 1.60±0.2 | 0.60±0.2 | 0.80±0.2 | 0.70 | 0.70 | 1.7 |
| SPH202012 | 2.0±0.1 | 2.0±0.1 | 1.2 Max. | 1.60±0.2 | 0.60±0.2 | 0.80±0.2 | 0.65 | 0.70 | 2.0 |
| SPH252010 | 2.5±0.2 | 2.0±0.2 | 1.0 Max. | 2.00±0.2 | 0.80±0.2 | 0.80±0.2 | 0.80 | 0.85 | 2.0 |
| SPH252012 | 2.5±0.2 | 2.0±0.2 | 1.2 Max. | 2.00±0.2 | 0.80±0.2 | 0.80±0.2 | 0.80 | 0.85 | 2.0 |
| SPH3012 | 3.0±0.2 | 3.0±0.2 | 1.2 Max. | 2.5±0.2 | 0.75±0.2 | 1.5±0.2 | 1.5 | 0.8 | 2.7 |
| SPH3015 | 3.0±0.2 | 3.0±0.2 | 1.5 Max. | 2.5±0.2 | 0.75±0.2 | 1.5±0.2 | 1.5 | 0.8 | 2.7 |
| SPH4012 | 4.0±0.2 | 4.0±0.2 | 1.2 Max. | 3.3±0.2 | 0.95±0.2 | 2.1±0.2 | 1.9 | 1.1 | 3.7 |
| SPH4018 | 4.0±0.2 | 4.0±0.2 | 1.8 Max. | 3.3±0.2 | 0.95±0.2 | 2.1±0.2 | 1.9 | 1.1 | 3.7 |
| SPH4020 | 4.0±0.2 | 4.0±0.2 | 2.0 Max. | 3.3±0.2 | 0.95±0.2 | 2.1±0.2 | 1.9 | 1.1 | 3.7 |
| SPH4030 | 4.0±0.2 | 4.0±0.2 | 3.0 Max. | 3.3±0.2 | 0.95±0.2 | 2.1±0.2 | 1.9 | 1.1 | 3.7 |
| SPH8030 | 8.0±0.3 | 8.0±0.3 | 3.0 Max. | 6.3±0.3 | 2.00±0.3 | 4.0±0.3 | 3.0 | 2.2 | 7.5 |

SPECIFICATIONS

SPH201610H Series

| Part Number | Inductance | DC Resistance | | Saturation Current | | Heat Rating Current | |
|-----------------|------------|---------------|-------|--------------------|------|---------------------|------|
| | @1MHz, 1V | Max. | Typ. | Max. | Typ. | Max. | Typ. |
| Units | μH | Ω | | A | | A | |
| Symbol | L | DCR | | Isat | | I _{rms} | |
| SPH201610HR16MT | 0.16±20% | 0.031 | 0.026 | 4.30 | 4.80 | 3.20 | 3.50 |
| SPH201610HR24MT | 0.24±20% | 0.040 | 0.033 | 3.70 | 4.10 | 2.90 | 3.20 |
| SPH201610HR33MT | 0.33±20% | 0.040 | 0.033 | 2.50 | 3.10 | 2.90 | 3.20 |
| SPH201610HR47MT | 0.47±20% | 0.059 | 0.049 | 2.30 | 2.85 | 2.35 | 2.60 |
| SPH201610HR68MT | 0.68±20% | 0.076 | 0.063 | 1.95 | 2.45 | 2.05 | 2.25 |
| SPH201610H1R0MT | 1.0±20% | 0.114 | 0.095 | 1.65 | 1.85 | 1.45 | 1.60 |
| SPH201610H1R5MT | 1.5±20% | 0.174 | 0.145 | 1.35 | 1.65 | 1.25 | 1.40 |
| SPH201610H2R2MT | 2.2±20% | 0.264 | 0.220 | 1.20 | 1.45 | 1.10 | 1.20 |
| SPH201610H3R3MT | 3.3±20% | 0.335 | 0.279 | 0.90 | 1.05 | 0.88 | 0.98 |
| SPH201610H4R7MT | 4.7±20% | 0.479 | 0.399 | 0.70 | 0.85 | 0.74 | 0.82 |
| SPH201610H6R8MT | 6.8±20% | 0.816 | 0.680 | 0.60 | 0.70 | 0.52 | 0.58 |
| SPH201610H100MT | 10±20% | 1.020 | 0.850 | 0.50 | 0.55 | 0.45 | 0.50 |

SPECIFICATIONS

SPH201610U Series

| Part Number | Inductance | DC Resistance | | Saturation Current | | Heat Rating Current | |
|--------------------|---------------|---------------|-------|--------------------|------|---------------------|------|
| | @1MHz, 1V | Max. | Typ. | Max. | Typ. | Max. | Typ. |
| Units | μH | Ω | | A | | A | |
| Symbol | L | DCR | | Isat | | Irms | |
| SPH201610U50NMT | 0.05±20% | 0.022 | 0.018 | 7.50 | 8.00 | 3.65 | 4.25 |
| SPH201610UR10MT | 0.10±20% | 0.022 | 0.018 | 4.80 | 5.70 | 3.65 | 4.25 |
| SPH201610UR16MT | 0.16±20% | 0.031 | 0.026 | 4.70 | 5.40 | 3.20 | 3.50 |
| SPH201610UR24MT | 0.24±20% | 0.040 | 0.033 | 4.50 | 5.00 | 2.90 | 3.20 |
| SPH201610UR33MT | 0.33±20% | 0.040 | 0.033 | 3.00 | 3.60 | 2.90 | 3.20 |
| SPH201610UR47MT | 0.47±20% | 0.052 | 0.043 | 2.90 | 3.40 | 2.35 | 2.60 |
| SPH201610UR47MTY01 | 0.47±20% | 0.045 | 0.037 | 2.50 | 2.90 | 2.75 | 3.00 |
| SPH201610UR68MT | 0.68±20% | 0.072 | 0.060 | 2.50 | 2.70 | 2.05 | 2.25 |
| SPH201610U1R0MT | 1.0±20% | 0.072 | 0.060 | 1.30 | 1.50 | 2.05 | 2.25 |
| SPH201610U2R2MT | 2.2±20% | 0.171 | 0.143 | 1.10 | 1.20 | 1.23 | 1.40 |

SPH202012H Series

| Part Number | Inductance | DC Resistance | | Saturation Current | | Heat Rating Current | |
|-----------------|---------------|---------------|-------|--------------------|------|---------------------|------|
| | @1MHz, 1V | Max. | Typ. | Max. | Typ. | Max. | Typ. |
| Units | μH | Ω | | A | | A | |
| Symbol | L | DCR | | Isat | | Irms | |
| SPH202012HR16MT | 0.16±20% | 0.031 | 0.026 | 5.20 | 5.80 | 2.50 | 2.75 |
| SPH202012HR24MT | 0.24±20% | 0.042 | 0.035 | 4.70 | 5.20 | 2.20 | 2.40 |
| SPH202012HR33MT | 0.33±20% | 0.042 | 0.035 | 3.50 | 4.00 | 2.20 | 2.40 |
| SPH202012HR47MT | 0.47±20% | 0.050 | 0.042 | 3.55 | 3.75 | 2.00 | 2.20 |
| SPH202012HR68MT | 0.68±20% | 0.060 | 0.050 | 2.95 | 3.10 | 1.80 | 2.00 |
| SPH202012H1R0MT | 1.0±20% | 0.088 | 0.073 | 2.70 | 2.85 | 1.50 | 1.65 |
| SPH202012H1R5MT | 1.5±20% | 0.112 | 0.093 | 2.00 | 2.20 | 1.30 | 1.45 |
| SPH202012H2R2MT | 2.2±20% | 0.127 | 0.106 | 1.40 | 1.65 | 1.20 | 1.35 |
| SPH202012H3R3MT | 3.3±20% | 0.276 | 0.230 | 1.20 | 1.35 | 0.85 | 0.95 |
| SPH202012H4R7MT | 4.7±20% | 0.294 | 0.245 | 0.97 | 1.10 | 0.82 | 0.90 |
| SPH202012H6R8MT | 6.8±20% | 0.479 | 0.399 | 0.82 | 0.92 | 0.64 | 0.70 |
| SPH202012H100MT | 10±20% | 0.785 | 0.654 | 0.72 | 0.82 | 0.49 | 0.54 |
| SPH202012H150MT | 15±20% | 1.368 | 1.140 | 0.55 | 0.65 | 0.38 | 0.42 |
| SPH202012H180MT | 18±20% | 1.680 | 1.400 | 0.60 | 0.68 | 0.35 | 0.38 |
| SPH202012H220MT | 22±20% | 1.680 | 1.400 | 0.40 | 0.50 | 0.35 | 0.38 |
| SPH202012H330MT | 33±20% | 2.160 | 1.800 | 0.35 | 0.40 | 0.30 | 0.33 |

SPH252010H Series

| Part Number | Inductance | DC Resistance | | Saturation Current | | Heat Rating Current | |
|--------------------|---------------|---------------|-------|--------------------|------|---------------------|------|
| | @1MHz, 1V | Max. | Typ. | Max. | Typ. | Max. | Typ. |
| Units | μH | Ω | | A | | A | |
| Symbol | L | DCR | | Isat | | Irms | |
| SPH252010HR24MT | 0.24±20% | 0.034 | 0.028 | 3.60 | 4.40 | 2.75 | 3.00 |
| SPH252010HR33MT | 0.33±20% | 0.043 | 0.036 | 3.80 | 4.60 | 2.40 | 2.65 |
| SPH252010HR47MT | 0.47±20% | 0.044 | 0.037 | 2.40 | 2.80 | 2.40 | 2.65 |
| SPH252010HR68MT | 0.68±20% | 0.061 | 0.051 | 2.75 | 3.10 | 2.10 | 2.35 |
| SPH252010HR68MTY01 | 0.68±20% | 0.061 | 0.051 | 2.75 | 3.10 | 2.10 | 2.35 |
| SPH252010HR68MTY02 | 0.68±20% | 0.065 | 0.055 | 3.20 | 3.50 | 2.10 | 2.30 |
| SPH252010H1R0MT | 1.0±20% | 0.080 | 0.067 | 2.05 | 2.45 | 1.80 | 2.00 |
| SPH252010H1R5MT | 1.5±20% | 0.108 | 0.090 | 1.70 | 2.05 | 1.55 | 1.70 |
| SPH252010H2R2MT | 2.2±20% | 0.137 | 0.114 | 1.55 | 1.80 | 1.40 | 1.55 |
| SPH252010H3R3MT | 3.3±20% | 0.228 | 0.170 | 1.10 | 1.40 | 1.10 | 1.20 |
| SPH252010H4R7MT | 4.7±20% | 0.323 | 0.269 | 1.00 | 1.15 | 0.91 | 1.00 |

SPECIFICATIONS

SPH252010H Series

| Part Number | Inductance | DC Resistance | | Saturation Current | | Heat Rating Current | |
|-----------------|---------------|---------------|-------|--------------------|------|---------------------|------|
| | @1MHz,1V | Max. | Typ. | Max. | Typ. | Max. | Typ. |
| Units | μH | Ω | | A | | A | |
| Symbol | L | DCR | | Isat | | Irms | |
| SPH252010H6R8MT | 6.8±20% | 0.451 | 0.376 | 0.82 | 0.95 | 0.76 | 0.84 |
| SPH252010H100MT | 10±20% | 0.584 | 0.487 | 0.65 | 0.75 | 0.67 | 0.74 |
| SPH252010H150MT | 15±20% | 0.954 | 0.795 | 0.55 | 0.65 | 0.50 | 0.55 |
| SPH252010H220MT | 22±20% | 1.548 | 1.290 | 0.45 | 0.55 | 0.40 | 0.45 |
| SPH252010H330MT | 33±20% | 1.548 | 1.290 | 0.25 | 0.30 | 0.40 | 0.45 |

SPH252012H Series

| Part Number | Inductance | DC Resistance | | Saturation Current | | Heat Rating Current | |
|--------------------|---------------|---------------|-------|--------------------|------|---------------------|------|
| | @1MHz,1V | Max. | Typ. | Max. | Typ. | Max. | Typ. |
| Units | μH | Ω | | A | | A | |
| Symbol | L | DCR | | Isat | | Irms | |
| SPH252012HR16MT | 0.16±20% | 0.022 | 0.018 | 6.50 | 7.20 | 4.05 | 4.50 |
| SPH252012HR24MT | 0.24±20% | 0.022 | 0.018 | 4.00 | 4.75 | 4.05 | 4.50 |
| SPH252012HR33MT | 0.33±20% | 0.029 | 0.024 | 4.00 | 4.70 | 3.35 | 3.70 |
| SPH252012HR47MT | 0.47±20% | 0.036 | 0.030 | 3.70 | 4.10 | 3.00 | 3.30 |
| SPH252012HR47MTY01 | 0.47±20% | 0.038 | 0.032 | 4.90 | 5.20 | 2.90 | 3.20 |
| SPH252012HR68MT | 0.68±20% | 0.061 | 0.051 | 3.00 | 3.30 | 2.10 | 2.30 |
| SPH252012HR68MTY01 | 0.68±20% | 0.042 | 0.035 | 3.20 | 3.50 | 2.50 | 2.70 |
| SPH252012HR68MTY02 | 0.68±20% | 0.060 | 0.051 | 3.80 | 4.20 | 2.10 | 2.30 |
| SPH252012H1R0MT | 1.0±20% | 0.044 | 0.037 | 1.70 | 1.90 | 2.20 | 2.40 |
| SPH252012H1R0MTY03 | 1.0±20% | 0.043 | 0.037 | 2.40 | 2.60 | 2.40 | 2.60 |
| SPH252012H1R2MT | 1.2±20% | 0.078 | 0.065 | 2.20 | 2.50 | 1.95 | 2.10 |
| SPH252012H1R5MT | 1.5±20% | 0.078 | 0.065 | 2.00 | 2.35 | 1.95 | 2.10 |
| SPH252012H2R2MT | 2.2±20% | 0.096 | 0.080 | 1.80 | 1.95 | 1.80 | 1.95 |
| SPH252012H3R3MT | 3.3±20% | 0.144 | 0.120 | 1.15 | 1.25 | 1.40 | 1.50 |
| SPH252012H4R7MT | 4.7±20% | 0.210 | 0.175 | 1.10 | 1.20 | 1.12 | 1.25 |
| SPH252012H6R8MT | 6.8±20% | 0.360 | 0.300 | 0.80 | 1.00 | 0.95 | 1.05 |
| SPH252012H100MT | 10±20% | 0.522 | 0.435 | 0.70 | 0.85 | 0.79 | 0.87 |
| SPH252012H150MT | 15±20% | 1.000 | 0.830 | 0.65 | 0.75 | 0.57 | 0.63 |
| SPH252012H180MT | 18±20% | 1.000 | 0.830 | 0.50 | 0.65 | 0.57 | 0.63 |
| SPH252012H220MT | 22±20% | 1.090 | 0.910 | 0.45 | 0.55 | 0.54 | 0.60 |
| SPH252012H330MT | 33±20% | 1.840 | 1.530 | 0.35 | 0.40 | 0.42 | 0.46 |
| SPH252012H470MT | 47±20% | 2.220 | 1.850 | 0.25 | 0.30 | 0.30 | 0.35 |

SPH3012H Series

| Part Number | Inductance | DC Resistance | | Saturation Current | | Heat Rating Current | |
|------------------|---------------|---------------|-------|--------------------|------|---------------------|------|
| | @1MHz,1V | Max. | Typ. | Max. | Typ. | Max. | Typ. |
| Units | μH | Ω | | A | | A | |
| Symbol | L | DCR | | Isat | | Irms | |
| SPH3012H1R0MT | 1.0±20% | 0.040 | 0.032 | 2.20 | 2.50 | 2.30 | 2.50 |
| SPH3012H1R0MTY02 | 1.0±20% | 0.056 | 0.047 | 2.80 | 3.20 | 1.90 | 2.00 |
| SPH3012H2R2MT | 2.2±20% | 0.090 | 0.075 | 1.50 | 1.80 | 1.40 | 1.60 |
| SPH3012H3R3MT | 3.3±20% | 0.134 | 0.112 | 1.23 | 1.55 | 1.40 | 1.60 |
| SPH3012H100MT | 10±20% | 0.372 | 0.310 | 0.75 | 0.90 | 0.75 | 0.80 |
| SPH3012H100MTY01 | 10±20% | 0.495 | 0.413 | 1.00 | 1.10 | 0.90 | 1.00 |
| SPH3012H220MT | 22±20% | 0.840 | 0.700 | 0.50 | 0.60 | 0.50 | 0.55 |

SPECIFICATIONS

SPH3015H Series

| Part Number | Inductance | DC Resistance | | Saturation Current | | Heat Rating Current | |
|---------------|---------------|---------------|-------|--------------------|------|---------------------|------|
| | @1MHz, 1V | Max. | Typ. | Max. | Typ. | Max. | Typ. |
| Units | μH | Ω | | A | | A | |
| Symbol | L | DCR | | Isat | | Irms | |
| SPH3015HR22MT | 0.22±20% | 0.022 | 0.018 | 6.00 | 6.80 | 3.00 | 3.50 |
| SPH3015HR24MT | 0.24±20% | 0.022 | 0.018 | 5.50 | 5.50 | 3.00 | 3.50 |
| SPH3015HR47MT | 0.47±20% | 0.022 | 0.018 | 2.40 | 2.80 | 3.00 | 3.50 |
| SPH3015HR55MT | 0.55±20% | 0.019 | 0.016 | 2.40 | 2.70 | 3.05 | 3.55 |
| SPH3015H1R0MT | 1.0±20% | 0.040 | 0.033 | 2.70 | 3.00 | 2.20 | 2.50 |
| SPH3015H1R5MT | 1.5±20% | 0.048 | 0.040 | 2.00 | 2.30 | 2.00 | 2.30 |
| SPH3015H2R2MT | 2.2±20% | 0.060 | 0.050 | 1.50 | 1.70 | 1.80 | 2.05 |
| SPH3015H3R3MT | 3.3±20% | 0.084 | 0.070 | 1.30 | 1.50 | 1.50 | 1.70 |
| SPH3015H3R9MT | 3.9±20% | 0.115 | 0.096 | 1.30 | 1.60 | 1.30 | 1.50 |
| SPH3015H4R7MT | 4.7±20% | 0.115 | 0.096 | 1.10 | 1.20 | 1.30 | 1.50 |
| SPH3015H6R8MT | 6.8±20% | 0.144 | 0.120 | 0.80 | 0.90 | 1.16 | 1.35 |
| SPH3015H100MT | 10±20% | 0.276 | 0.230 | 0.75 | 0.90 | 0.84 | 0.97 |
| SPH3015H150MT | 15±20% | 0.360 | 0.300 | 0.60 | 0.70 | 0.73 | 0.84 |
| SPH3015H220MT | 22±20% | 0.540 | 0.450 | 0.52 | 0.60 | 0.60 | 0.70 |
| SPH3015H260MT | 26±20% | 0.768 | 0.640 | 0.40 | 0.50 | 0.45 | 0.55 |
| SPH3015H330MT | 33±20% | 1.090 | 0.910 | 0.50 | 0.55 | 0.50 | 0.55 |
| SPH3015H470MT | 47±20% | 1.250 | 1.040 | 0.35 | 0.42 | 0.45 | 0.50 |

SPH4012H Series

| Part Number | Inductance | DC Resistance | | Saturation Current | | Heat Rating Current | |
|------------------|---------------|---------------|-------|--------------------|------|---------------------|------|
| | @0.1MHz, 1V | Max. | Typ. | Max. | Typ. | Max. | Typ. |
| Units | μH | Ω | | A | | A | |
| Symbol | L | DCR | | Isat | | Irms | |
| SPH4012HR33NT | 0.33±30% | 0.031 | 0.026 | 5.50 | 6.30 | 2.90 | 3.35 |
| SPH4012HR47NT | 0.47±30% | 0.032 | 0.027 | 3.50 | 4.20 | 2.90 | 3.20 |
| SPH4012HR82NT | 0.82±30% | 0.042 | 0.035 | 3.00 | 3.50 | 2.50 | 2.90 |
| SPH4012H1R0NT | 1.0±30% | 0.050 | 0.042 | 2.80 | 3.30 | 2.20 | 2.50 |
| SPH4012H1R5NT | 1.5±30% | 0.050 | 0.042 | 2.10 | 2.20 | 2.20 | 2.50 |
| SPH4012H1R8NT | 1.8±30% | 0.066 | 0.055 | 2.10 | 2.40 | 2.00 | 2.30 |
| SPH4012H2R2MT | 2.2±20% | 0.066 | 0.055 | 1.70 | 1.80 | 2.00 | 2.30 |
| SPH4012H2R7MT | 2.7±20% | 0.084 | 0.070 | 1.90 | 2.20 | 1.70 | 2.00 |
| SPH4012H3R3MT | 3.3±20% | 0.084 | 0.070 | 1.40 | 1.70 | 1.70 | 2.00 |
| SPH4012H3R6MT | 3.6±20% | 0.090 | 0.075 | 1.20 | 1.60 | 1.70 | 2.00 |
| SPH4012H4R3MT | 4.3±20% | 0.108 | 0.090 | 1.20 | 1.50 | 1.50 | 1.80 |
| SPH4012H4R7MT | 4.7±20% | 0.108 | 0.090 | 1.20 | 1.30 | 1.50 | 1.80 |
| SPH4012H5R1MT | 5.1±20% | 0.132 | 0.110 | 1.20 | 1.40 | 1.40 | 1.60 |
| SPH4012H5R6MT | 5.6±20% | 0.132 | 0.110 | 1.10 | 1.40 | 1.40 | 1.60 |
| SPH4012H6R8MT | 6.8±20% | 0.150 | 0.125 | 0.90 | 1.10 | 1.30 | 1.60 |
| SPH4012H100MT | 10±20% | 0.204 | 0.170 | 0.80 | 0.90 | 1.10 | 1.30 |
| SPH4012H100MTY01 | 10±20% | 0.240 | 0.200 | 0.90 | 1.10 | 1.00 | 1.10 |
| SPH4012H120MT | 12±20% | 0.312 | 0.260 | 0.85 | 1.00 | 0.90 | 1.00 |
| SPH4012H150MT | 15±20% | 0.312 | 0.260 | 0.65 | 0.80 | 0.90 | 1.00 |
| SPH4012H180MT | 18±20% | 0.432 | 0.360 | 0.65 | 0.80 | 0.78 | 0.90 |
| SPH4012H220MT | 22±20% | 0.460 | 0.380 | 0.50 | 0.65 | 0.78 | 0.90 |
| SPH4012H270MT | 27±20% | 0.672 | 0.560 | 0.50 | 0.60 | 0.63 | 0.73 |
| SPH4012H330MT | 33±20% | 0.756 | 0.630 | 0.45 | 0.55 | 0.57 | 0.68 |
| SPH4012H360MT | 36±20% | 0.756 | 0.630 | 0.40 | 0.50 | 0.57 | 0.68 |
| SPH4012H390MT | 39±20% | 1.188 | 0.990 | 0.55 | 0.62 | 0.47 | 0.54 |

SPECIFICATIONS

SPH4012H Series

| Part Number | Inductance | DC Resistance | | Saturation Current | | Heat Rating Current | |
|---------------|---------------|---------------|-------|--------------------|------|---------------------|------|
| | @0.1MHz,1V | Max. | Typ. | Max. | Typ. | Max. | Typ. |
| Units | μH | Ω | | A | | A | |
| Symbol | L | DCR | | Isat | | Irms | |
| SPH4012H470MT | 47±20% | 1.188 | 0.990 | 0.40 | 0.50 | 0.47 | 0.54 |
| SPH4012H560MT | 56±20% | 1.320 | 1.100 | 0.35 | 0.45 | 0.45 | 0.52 |
| SPH4012H680MT | 68±20% | 1.800 | 1.500 | 0.38 | 0.45 | 0.38 | 0.44 |
| SPH4012H820MT | 82±20% | 2.040 | 1.700 | 0.30 | 0.38 | 0.36 | 0.42 |
| SPH4012H101MT | 100±20% | 2.040 | 1.700 | 0.25 | 0.31 | 0.36 | 0.42 |

SPH4018H Series

| Part Number | Inductance | DC Resistance | | Saturation Current | | Heat Rating Current | |
|---------------|---------------|---------------|-------|--------------------|------|---------------------|------|
| | @0.1MHz,1V | Max. | Typ. | Max. | Typ. | Max. | Typ. |
| Units | μH | Ω | | A | | A | |
| Symbol | L | DCR | | Isat | | Irms | |
| SPH4018HR33NT | 0.33±30% | 0.016 | 0.012 | 6.50 | 8.00 | 4.20 | 4.70 |
| SPH4018HR47NT | 0.47±30% | 0.020 | 0.017 | 6.50 | 7.20 | 3.50 | 4.00 |
| SPH4018H1R0NT | 1.0±30% | 0.032 | 0.027 | 4.00 | 4.80 | 3.20 | 3.70 |
| SPH4018H1R5NT | 1.5±30% | 0.037 | 0.031 | 3.60 | 4.30 | 2.95 | 3.30 |
| SPH4018H2R2MT | 2.2±20% | 0.050 | 0.042 | 3.00 | 3.40 | 2.20 | 2.90 |
| SPH4018H3R3MT | 3.3±20% | 0.066 | 0.055 | 2.30 | 2.90 | 2.00 | 2.50 |
| SPH4018H4R7MT | 4.7±20% | 0.084 | 0.070 | 2.00 | 2.20 | 1.70 | 2.10 |
| SPH4018H6R8MT | 6.8±20% | 0.118 | 0.098 | 1.60 | 1.80 | 1.45 | 1.70 |
| SPH4018H100MT | 10±20% | 0.180 | 0.150 | 1.30 | 1.50 | 1.20 | 1.50 |
| SPH4018H150MT | 15±20% | 0.252 | 0.210 | 1.10 | 1.20 | 0.85 | 1.20 |
| SPH4018H220MT | 22±20% | 0.348 | 0.290 | 0.90 | 1.10 | 0.70 | 1.00 |
| SPH4018H330MT | 33±20% | 0.552 | 0.460 | 0.70 | 0.90 | 0.55 | 0.82 |
| SPH4018H470MT | 47±20% | 0.744 | 0.620 | 0.57 | 0.70 | 0.91 | 1.01 |
| SPH4018H680MT | 68±20% | 0.972 | 0.810 | 0.53 | 0.62 | 0.68 | 0.73 |
| SPH4018H101MT | 100±20% | 1.560 | 1.300 | 0.49 | 0.57 | 0.40 | 0.47 |
| SPH4018H151MT | 150±20% | 3.120 | 2.600 | 0.41 | 0.47 | 0.28 | 0.33 |
| SPH4018H221MT | 220±20% | 3.840 | 3.200 | 0.33 | 0.38 | 0.25 | 0.29 |
| SPH4018H331MT | 330±20% | 5.880 | 4.900 | 0.26 | 0.31 | 0.20 | 0.23 |

SPH4020H Series

| Part Number | Inductance | DC Resistance | | Saturation Current | | Heat Rating Current | |
|---------------|---------------|---------------|-------|--------------------|------|---------------------|------|
| | @0.1MHz,1V | Max. | Typ. | Max. | Typ. | Max. | Typ. |
| Units | μH | Ω | | A | | A | |
| Symbol | L | DCR | | Isat | | Irms | |
| SPH4020HR33NT | 0.33±30% | 0.016 | 0.013 | 7.50 | 8.50 | 3.30 | 4.90 |

SPH4030H Series

| Part Number | Inductance | DC Resistance | | Saturation Current | | Heat Rating Current | |
|---------------|---------------|---------------|-------|--------------------|-------|---------------------|------|
| | @0.1MHz,1V | Max. | Typ. | Max. | Typ. | Max. | Typ. |
| Units | μH | Ω | | A | | A | |
| Symbol | L | DCR | | Isat | | Irms | |
| SPH4030HR10NT | 0.10±30% | 0.005 | 0.006 | 17.00 | 18.50 | 4.60 | 6.30 |
| SPH4030HR22NT | 0.22±30% | 0.007 | 0.006 | 11.50 | 12.50 | 3.90 | 5.20 |
| SPH4030HR47NT | 0.47±30% | 0.013 | 0.011 | 8.20 | 9.20 | 4.50 | 5.20 |

SPECIFICATIONS

SPH8030H Series

| Part Number | Inductance | DC Resistance | | Saturation Current | | Heat Rating Current | |
|---------------|---------------|---------------|-------|--------------------|------|---------------------|------|
| | @0.1MHz,1V | Max. | Typ. | Max. | Typ. | Max. | Typ. |
| Units | μH | Ω | | A | | A | |
| Symbol | L | DCR | | Isat | | I _{rms} | |
| SPH8030H1R0NT | 1.0±30% | 0.012 | 0.009 | 7.80 | 9.00 | 6.20 | 7.30 |
| SPH8030H1R5NT | 1.5±30% | 0.016 | 0.012 | 6.20 | 7.60 | 5.30 | 6.20 |
| SPH8030H2R2MT | 2.2±20% | 0.020 | 0.015 | 4.90 | 6.30 | 4.80 | 5.70 |
| SPH8030H3R3MT | 3.3±20% | 0.025 | 0.019 | 4.20 | 5.10 | 4.30 | 5.10 |
| SPH8030H4R7MT | 4.7±20% | 0.029 | 0.022 | 3.60 | 4.30 | 4.00 | 4.70 |
| SPH8030H6R8MT | 6.8±20% | 0.038 | 0.029 | 3.00 | 3.50 | 3.40 | 3.90 |
| SPH8030H100MT | 10±20% | 0.043 | 0.033 | 2.40 | 2.80 | 3.00 | 3.70 |
| SPH8030H150MT | 15±20% | 0.078 | 0.060 | 2.00 | 2.40 | 2.20 | 2.80 |
| SPH8030H220MT | 22±20% | 0.091 | 0.070 | 1.75 | 2.00 | 1.90 | 2.40 |
| SPH8030H330MT | 33±20% | 0.156 | 0.120 | 1.30 | 1.70 | 1.50 | 2.10 |
| SPH8030H470MT | 47±20% | 0.221 | 0.170 | 1.10 | 1.40 | 1.30 | 1.70 |

※1 : All test data is referenced to 20°C ambient;

※2 : Rated current: Isat or I_{rms}, whichever is smaller;

※Isat: DC current at which the inductance drops approximate 30% from its value without current;

※I_{rms}: DC current that causes the temperature rise ($\Delta T = 40^\circ\text{C}$) from 20°C ambient.

TYPICAL ELECTRICAL CHARACTERISTICS

SPH201610H Series

Temperature vs. DC Current Characteristics

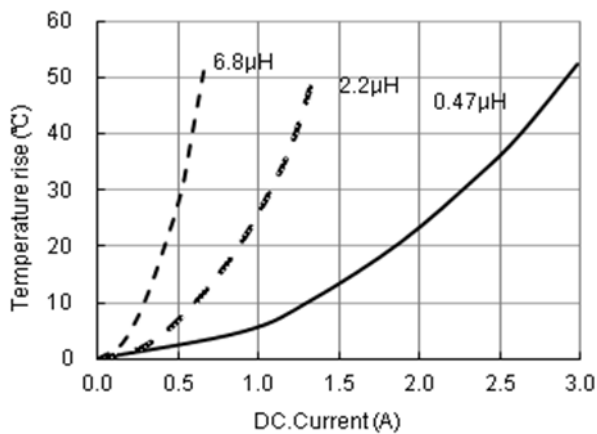

Inductance vs. DC Current Characteristics

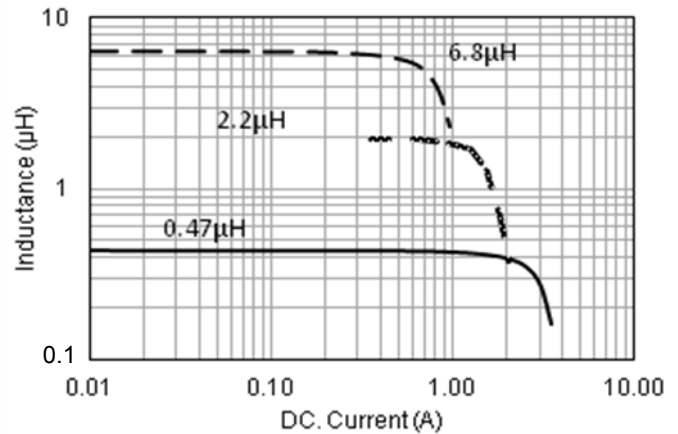

SPH202012H Series

Temperature vs. DC Current Characteristics

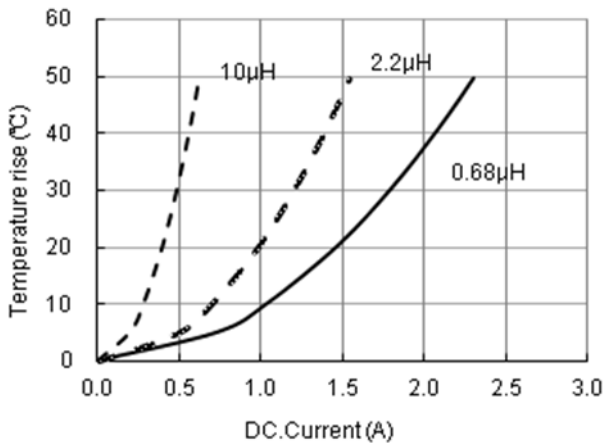

Inductance vs. DC Current Characteristics

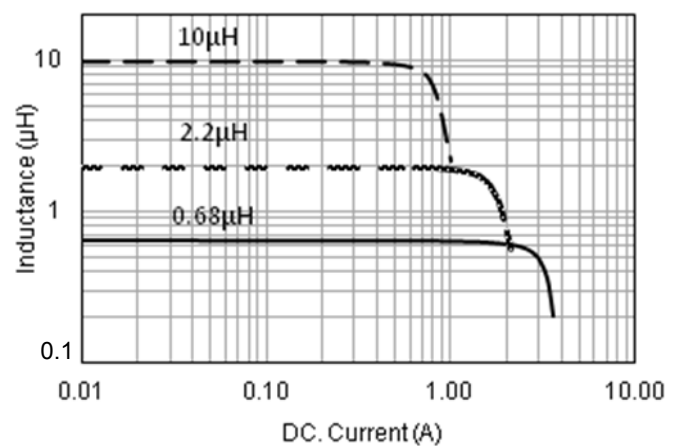

TYPICAL ELECTRICAL CHARACTERISTICS

SPH252010H Series

Temperature vs. DC Current Characteristics



Inductance vs. DC Current Characteristics



SPH252012H Series

Temperature vs. DC Current Characteristics



Inductance vs. DC Current Characteristics

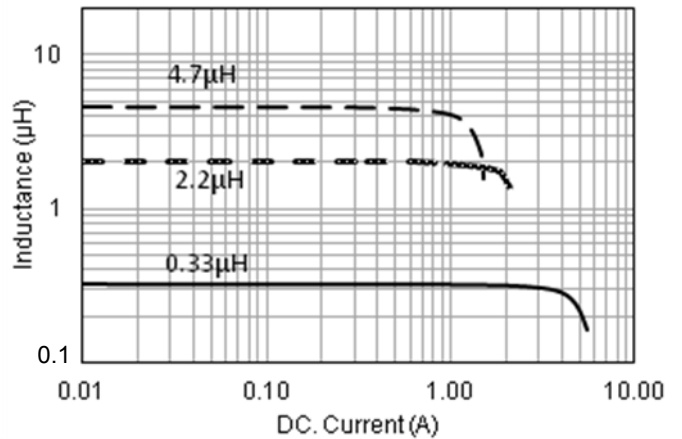

SPH3012H Series

Temperature vs. DC Current Characteristics



Inductance vs. DC Current Characteristics

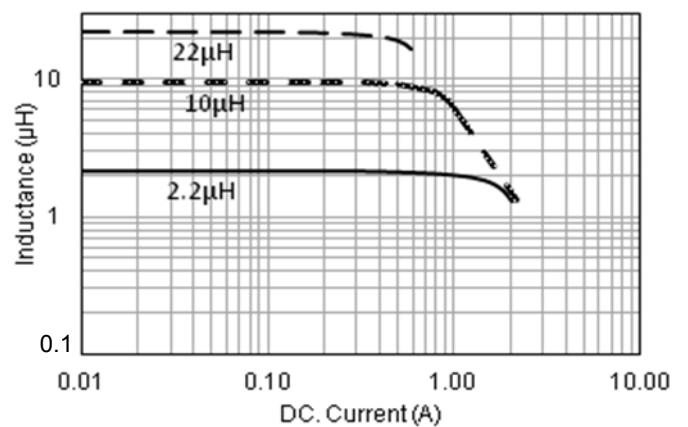

TYPICAL ELECTRICAL CHARACTERISTICS

SPH3015H Series

Temperature vs. DC Current Characteristics

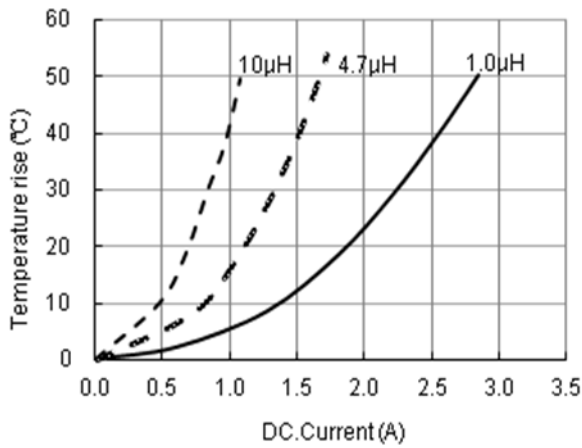

Inductance vs. DC Current Characteristics



SPH4012H Series

Temperature vs. DC Current Characteristics

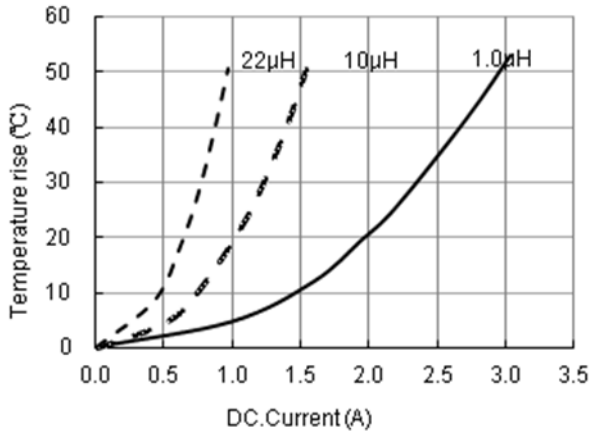

Inductance vs. DC Current Characteristics



SPH4018H Series

Temperature vs. DC Current Characteristics

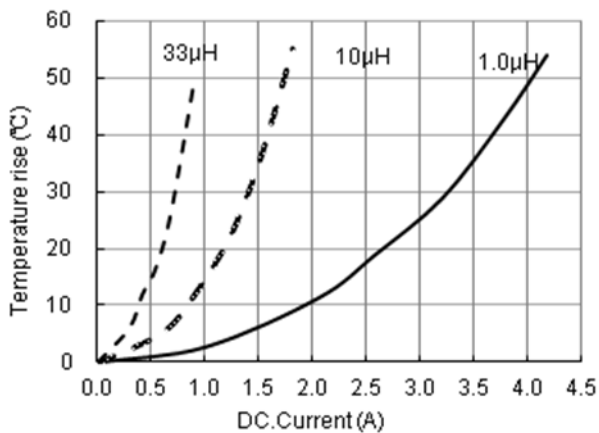

Inductance vs. DC Current Characteristics



TYPICAL ELECTRICAL CHARACTERISTICS

SPH4020H Series

Temperature vs. DC Current Characteristics

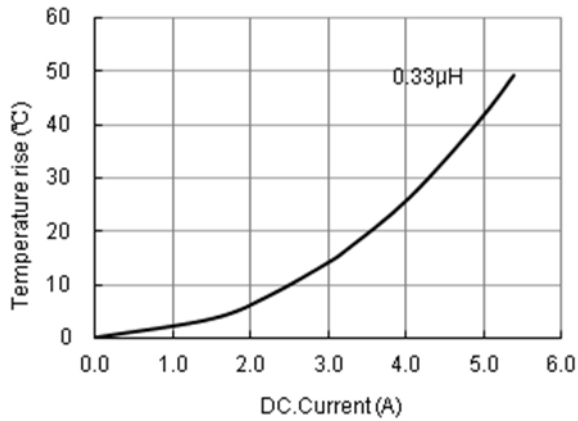

Inductance vs. DC Current Characteristics



SPH4030H Series

Temperature vs. DC Current Characteristics

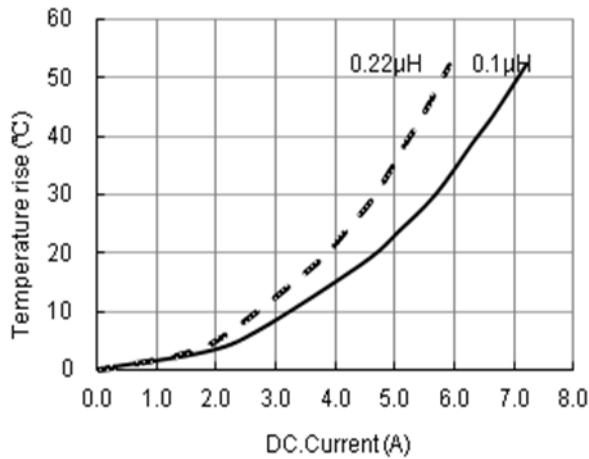

Inductance vs. DC Current Characteristics



SPH8030H Series

Temperature vs. DC Current Characteristics

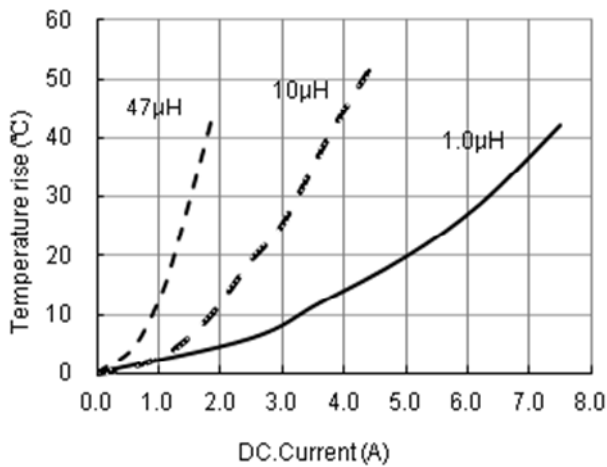

Inductance vs. DC Current Characteristics

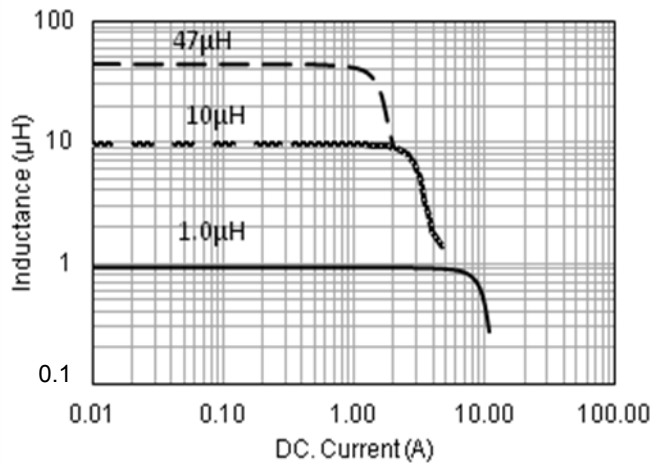

X-ON Electronics

Largest Supplier of Electrical and Electronic Components

Click to view similar products for [Fixed Inductors](#) category:

Click to view products by [Sunlord](#) manufacturer:

Other Similar products are found below :

[MLZ1608M6R8WTD25](#) [MLZ1608N6R8LT000](#) [MLZ1608N3R3LTD25](#) [MLZ1608N3R3LT000](#) [MLZ1608N150LT000](#)
[MLZ1608M150WTD25](#) [MLZ1608M3R3WTD25](#) [MLZ1608M3R3WT000](#) [MLZ1608M150WT000](#) [MLZ1608A1R5WT000](#)
[MLZ1608N1R5LT000](#) [B82432C1333K000](#) [PCMB053T-1R0MS](#) [PCMB053T-1R5MS](#) [PCMB104T-1R5MS](#) [CR32NP-100KC](#) [CR32NP-151KC](#) [CR32NP-180KC](#) [CR32NP-181KC](#) [CR32NP-1R5MC](#) [CR32NP-390KC](#) [CR32NP-3R9MC](#) [CR32NP-680KC](#) [CR32NP-820KC](#)
[CR32NP-8R2MC](#) [CR43NP-390KC](#) [CR43NP-560KC](#) [CR43NP-680KC](#) [CR54NP-181KC](#) [CR54NP-470LC](#) [CR54NP-820KC](#) [CR54NP-8R5MC](#)
[MGDQ4-00004-P](#) [MGDU1-00016-P](#) [MHL1ECTTP18NJ](#) [MHL1JCTTD12NJ](#) [PE-51506NL](#) [PE-53601NL](#) [PE-53630NL](#) [PE-53824SNLT](#) [PE-62892NL](#) [PE-92100NL](#) [PG0434.801NLT](#) [PG0936.113NLT](#) [PM06-2N7](#) [PM06-39NJ](#) [HC2LP-R47-R](#) [HC2-R47-R](#) [HC3-2R2-R](#) [HC8-1R2-R](#)