

# Multilayer Chip Ferrite Bead – SZ Series

Operating Temp. : -55°C~+125°C

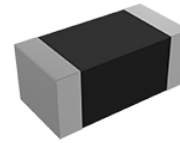

## FEATURES

- Internal silver printed layers and magnetic shielded structures to minimize crosstalk
- It has sharp impedance characteristics at desirable frequency and does not affect the signal frequency
- Three types material and wide range of impedance values for various applications

## APPLICATIONS

- Noise suppression for high speed signal of electric equipments such as computers and peripheral devices, DVD cameras, LCD TVs, communication equipments, OA equipments, etc.

## PRODUCT IDENTIFICATION

**SZ**  
①

Type	
SZ	Chip Ferrite Bead For High Speed

**1608**  
②

**G**  
③

External Dimensions (LxW) (mm)	
0603 [0201]	0.6x0.3
1005 [0402]	1.0x0.5
1608 [0603]	1.6x0.8
2012 [0805]	2.0x1.25

**121**  
④

Nominal Impedance	
Example	Nominal Value
300	30Ω
121	120Ω
102	1000Ω

**T**  
⑤

Packing	
T	Tape & Reel

**F**  
⑥

Material Code
F, G, K, Q

⑥

Hazardous Substance Free Products
F

## SHAPE AND DIMENSIONS

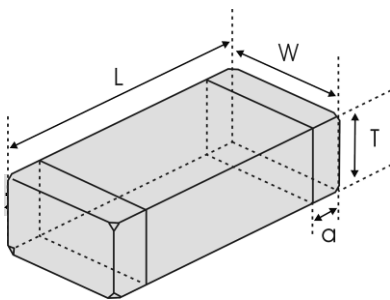

Unit: mm [inch]

Type	L	W	T	a
SZ0603 [0201]	0.6±0.05 [.024±.002]	0.3±0.05 [.012±.002]	0.3±0.05 [.012±.002]	0.15±0.05 [.006±.002]
SZ1005 [0402]	1.0±0.15 [.039±.006]	0.5±0.15 [.020±.006]	0.5±0.15 [.020±.006]	0.25±0.1 [.010±.004]
SZ1608 [0603]	1.6±0.15 [.063±.006]	0.8±0.15 [.031±.006]	0.8±0.15 [.031±.006]	0.3±0.2 [.012±.008]
SZ2012 [0805]	2.0 (+0.3, -0.1) [.079 (+.012, -.004)]	1.25±0.2 [.049±.008]	0.85±0.2 [.033±.008]	0.5±0.3 [.020±.012]

## SPECIFICATIONS

### SZ0603 TYPE

Part Number	Impedance	Z Test Frequency	Max. DC Resistance	Max. Rated Current	Thickness
Units	$\Omega$	MHz	$\Omega$	mA	mm [inch]
Symbol	Z	Freq.	DCR	I <sub>r</sub>	T
SZ0603F330TF	33±25%	100	0.85	150	0.3±0.05 [.012±.002]
SZ0603F560TF	56±25%	100	1.05	100	
SZ0603F800TF	80±25%	100	1.40	100	
SZ0603G100TF	10±25%	100	0.25	200	
SZ0603G220TF	22±25%	100	0.45	200	
SZ0603G330TF	33±25%	100	0.55	150	
SZ0603G470TF	47±25%	100	0.70	150	
SZ0603G560TF	56±25%	100	1.00	100	
SZ0603G800TF	80±25%	100	1.30	100	
SZ0603G121TF	120±25%	100	1.50	100	
SZ0603K100TF	5~15	100	0.40	300	
SZ0603K220TF	22±25%	100	0.50	200	
SZ0603K470TF	47±25%	100	0.70	200	
SZ0603K750TF	75±25%	100	1.00	200	
SZ0603K121TF	120±25%	100	1.50	100	
SZ0603Q750TF	75±25%	100	0.40	300	
SZ0603Q121TF	120±25%	100	0.50	250	
SZ0603Q241TF	240±25%	100	0.80	200	
SZ0603Q471TF	470±25%	100	1.50	215	
SZ0603Q601TF	600±25%	100	1.70	200	

### SZ1005 TYPE

Part Number	Impedance	Z Test Frequency	Max. DC Resistance	Max. Rated Current	Thickness
Units	$\Omega$	MHz	$\Omega$	mA	mm [inch]
Symbol	Z	Freq.	DCR	I <sub>r</sub>	T
SZ1005F050TF	0~10	100	0.10	300	0.5±0.15 [.020±.006]
SZ1005F100TF	5~15	100	0.20	300	
SZ1005F330TF	33±25%	100	0.40	300	
SZ1005G050TF	0~15	100	0.15	600	
SZ1005G300TF	30±25%	100	0.15	600	
SZ1005G750TF	75±25%	100	0.30	600	
SZ1005G121TF	120±25%	100	0.40	400	
SZ1005G221TF	220±25%	100	0.70	200	
SZ1005K750TF	75±25%	100	0.30	600	
SZ1005K121TF	120±25%	100	0.40	400	
SZ1005K221TF	220±25%	100	0.70	200	
SZ1005K301TF	300±25%	100	0.80	200	
SZ1005K421TF	420±25%	100	1.00	150	
SZ1005K601TF	600±25%	100	1.10	100	
SZ1005K102TF	1000±25%	100	1.20	100	
SZ1005K152TF	1500±25%	100	1.40	100	
SZ1005K182TF	1800±25%	100	1.80	50	

### SZ1608 TYPE

Part Number	Impedance	Z Test Frequency	Max. DC Resistance	Max. Rated Current	Thickness
Units	$\Omega$	MHz	$\Omega$	mA	mm [inch]
Symbol	Z	Freq.	DCR	I <sub>r</sub>	T
SZ1608F050TF	0~10	100	0.20	500	0.8±0.15 [.031±.006]
SZ1608F100TF	5~15	100	0.25	500	
SZ1608F220TF	22±25%	100	0.35	500	

## SPECIFICATIONS

### SZ1608 TYPE

Part Number	Impedance	Z Test Frequency	Max. DC Resistance	Max. Rated Current	Thickness
Units	$\Omega$	MHz	$\Omega$	mA	mm [inch]
Symbol	Z	Freq.	DCR	I <sub>r</sub>	T
SZ1608F470TF	47±25%	100	0.55	300	0.8±0.15 [.031±.006]
SZ1608F750TF	75±25%	100	0.70	300	
SZ1608F121TF	120±25%	100	0.90	200	
SZ1608G050TF	0~15	100	0.10	800	
SZ1608G220TF	22±25%	100	0.20	800	
SZ1608G600TF	60±25%	100	0.30	600	
SZ1608G121TF	120±25%	100	0.45	600	
SZ1608G221TF	220±25%	100	0.55	500	
SZ1608G331TF	330±25%	100	0.70	500	
SZ1608G471TF	470±25%	100	0.80	400	
SZ1608G601TF	600±25%	100	1.10	200	
SZ1608G102TF	1000±25%	100	1.20	150	
SZ1608K121TF	120±25%	100	0.40	600	
SZ1608K221TF	220±25%	100	0.45	500	
SZ1608K331TF	330±25%	100	0.50	500	
SZ1608K421TF	420±25%	100	0.55	400	
SZ1608K471TF	470±25%	100	0.55	400	
SZ1608K601TF	600±25%	100	0.60	200	
SZ1608K102TF	1000±25%	100	0.80	200	
SZ1608K152TF	1500±25%	100	0.80	200	
SZ1608K202TF	2000±25%	100	1.00	200	
SZ1608K222TF	2200±25%	100	1.00	200	
SZ1608K252TF	2500±25%	100	1.20	200	
SZ1608K272TF	2700±25%	100	1.40	200	

### SZ2012 TYPE

Part Number	Impedance	Z Test Frequency	Max. DC Resistance	Max. Rated Current	Thickness
Units	$\Omega$	MHz	$\Omega$	mA	mm [inch]
Symbol	Z	Freq.	DCR	I <sub>r</sub>	T
SZ2012G050TF	0~15	100	0.07	1000	0.85±0.2 [.033±.008]
SZ2012G600TF	60±25%	100	0.20	800	
SZ2012G121TF	120±25%	100	0.25	600	
SZ2012G221TF	220±25%	100	0.30	600	
SZ2012G421TF	420±25%	100	0.40	600	
SZ2012G601TF	600±25%	100	0.45	600	
SZ2012G102TF	1000±25%	100	0.50	500	
SZ2012K121TF	120±25%	100	0.20	600	
SZ2012K221TF	220±25%	100	0.25	600	
SZ2012K301TF	300±25%	100	0.30	600	
SZ2012K601TF	600±25%	100	0.35	600	
SZ2012K102TF	1000±25%	100	0.40	500	
SZ2012K152TF	1500±25%	100	0.45	200	
SZ2012K222TF	2200±25%	100	0.60	200	
SZ2012K252TF	2500±25%	100	0.70	200	
SZ2012K272TF	2700±25%	100	0.80	200	

※: Products with other electrical characteristics can be provided upon customer's request. Please contact your local sales.

# TYPICAL ELECTRICAL CHARACTERISTICS

## F, G, K Material Comparison

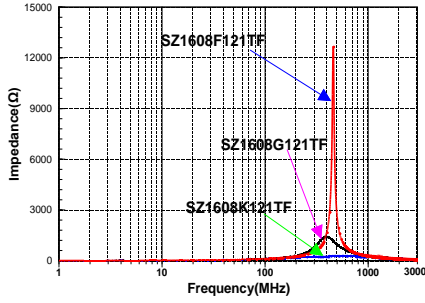

# DETAIL ELECTRICAL CHARACTERISTICS

## SZ0603 TYPE

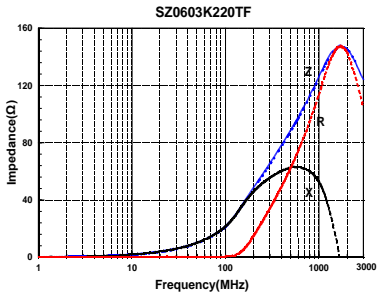
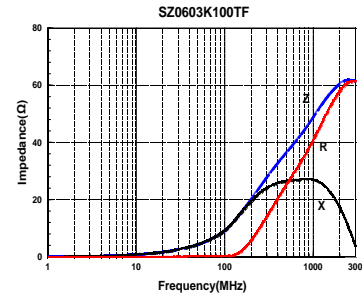
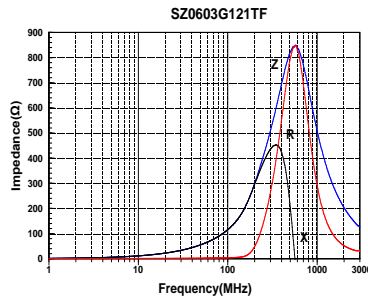
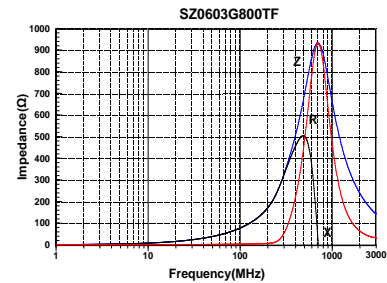
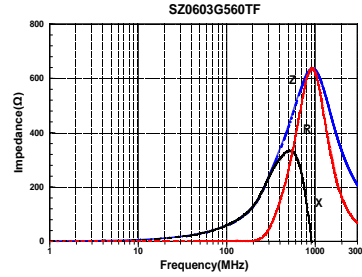
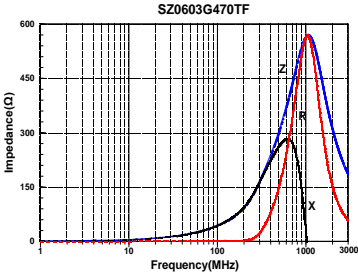
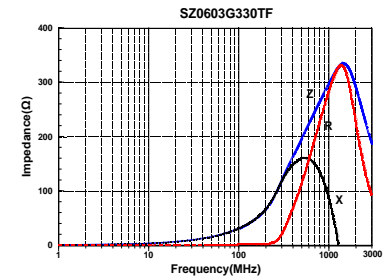
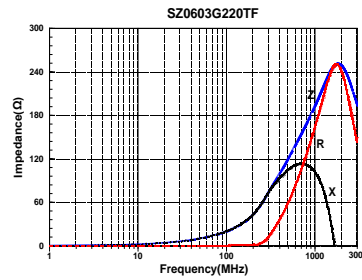
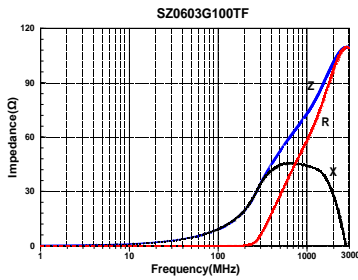
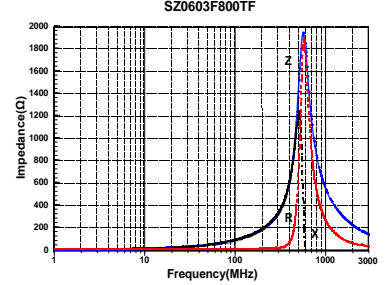
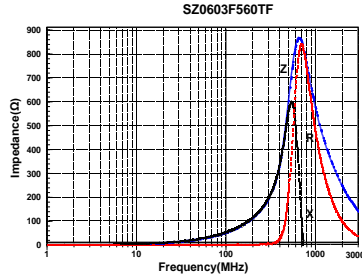
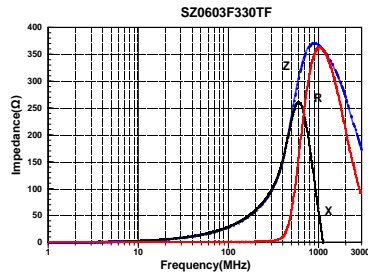

# DETAIL ELECTRICAL CHARACTERISTICS

## SZ0603 TYPE

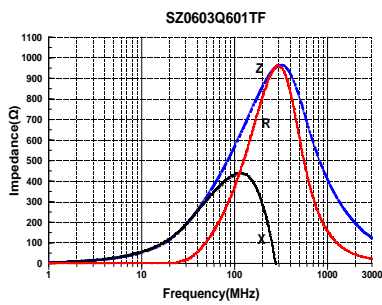
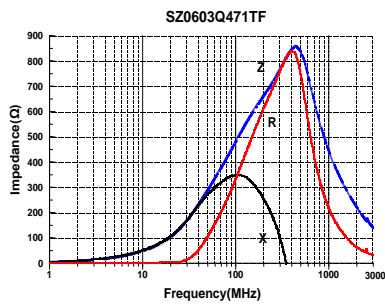
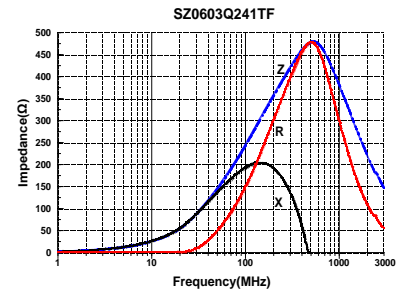
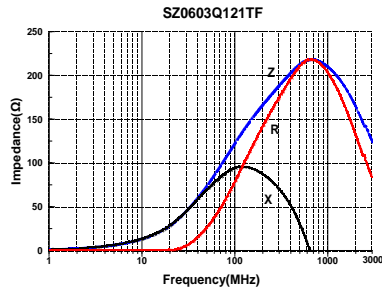
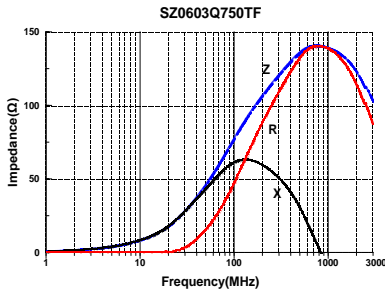
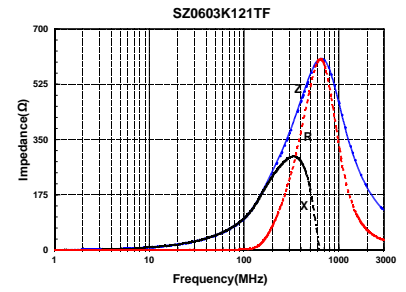
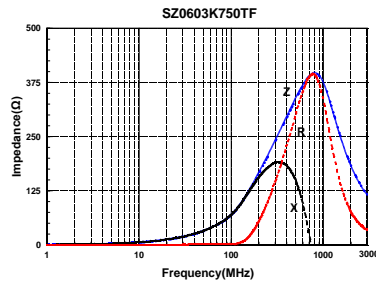
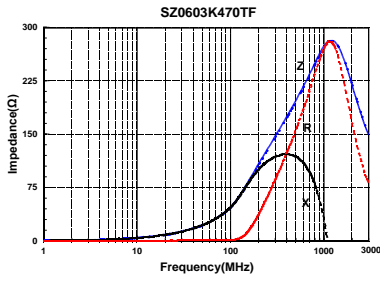

## SZ1005 TYPE

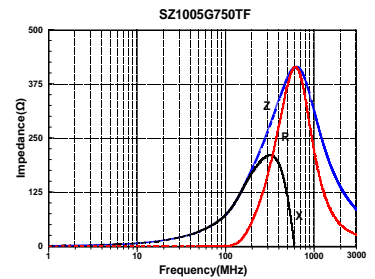
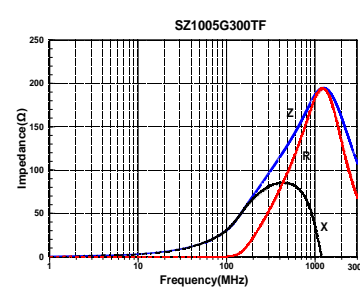
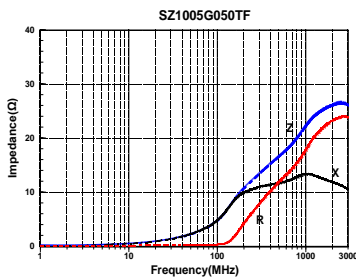
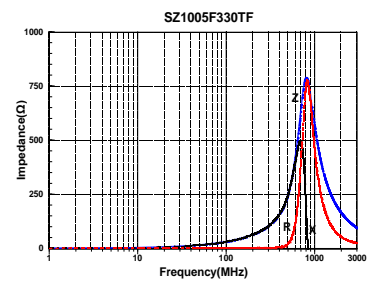
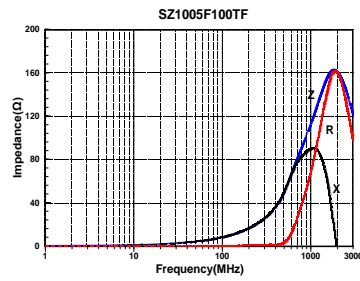
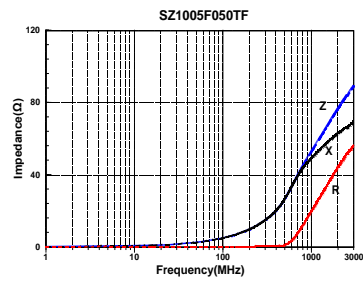

# DETAIL ELECTRICAL CHARACTERISTICS

## SZ1005 TYPE

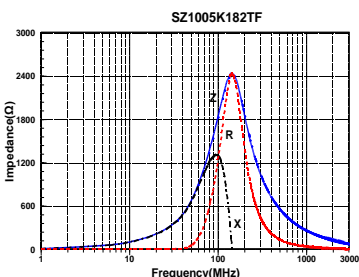
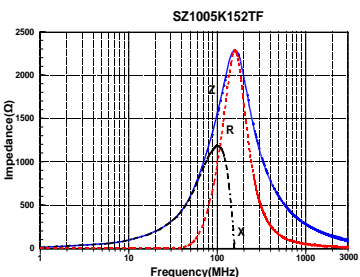
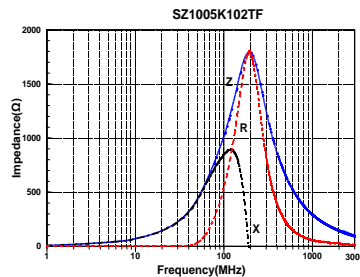
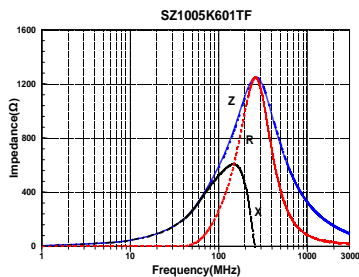
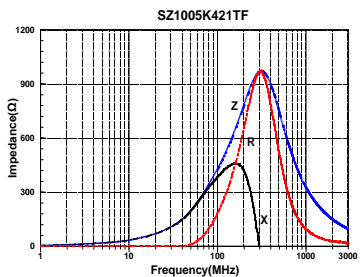
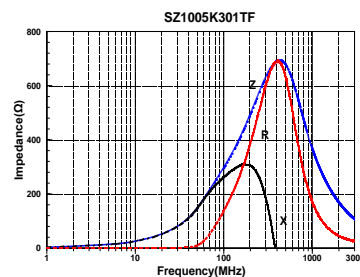
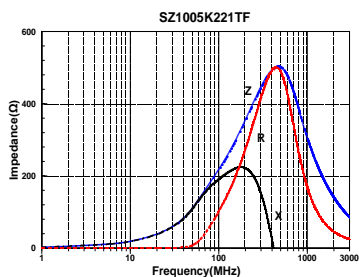
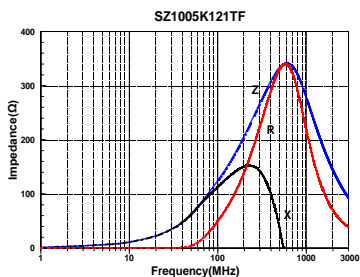
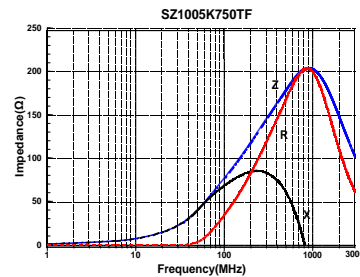
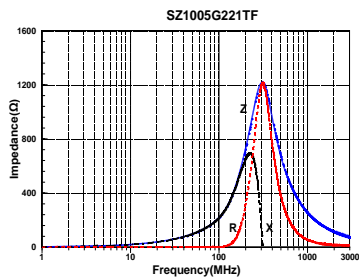
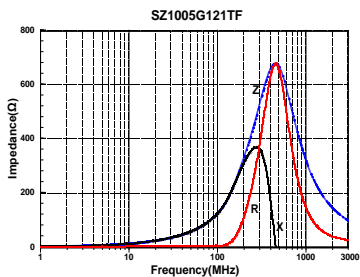

## SZ1608 TYPE

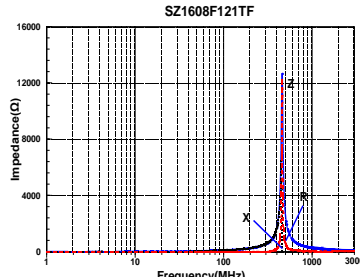
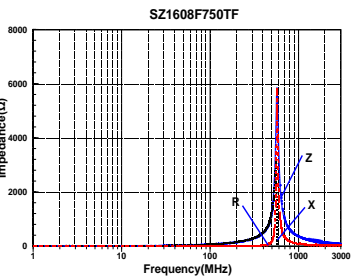
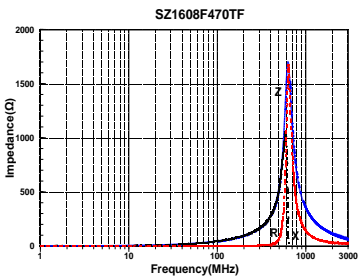
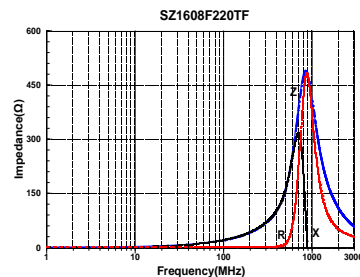
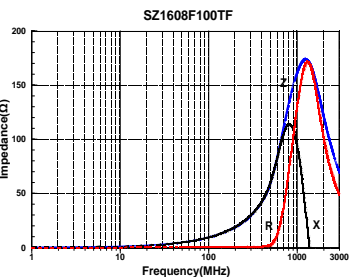
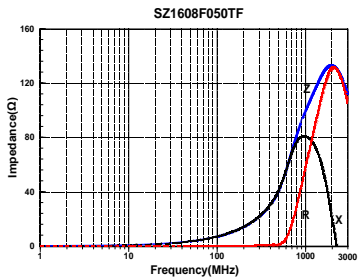

# DETAIL ELECTRICAL CHARACTERISTICS

## SZ1608 TYPE

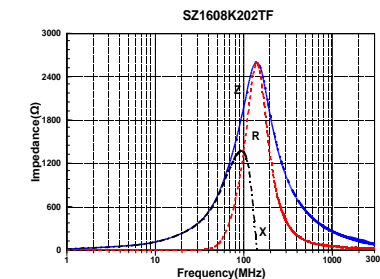
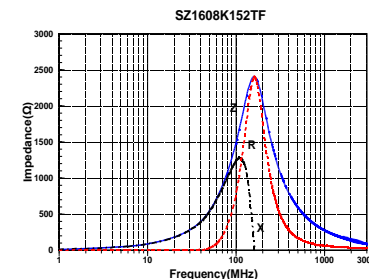
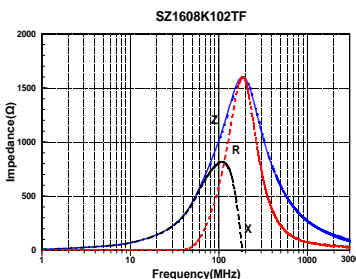
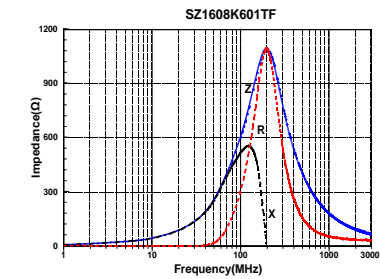
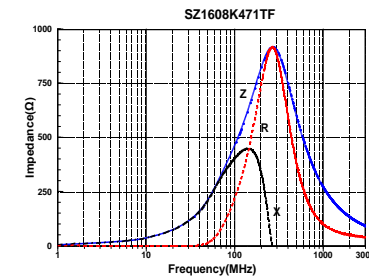
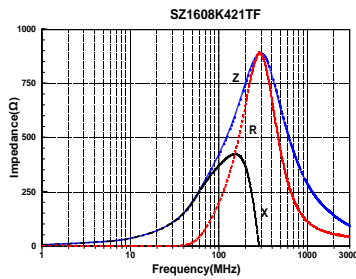
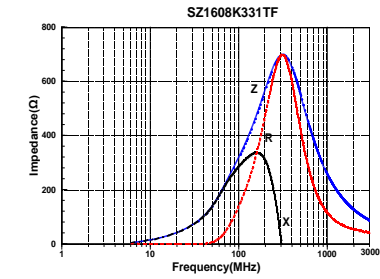
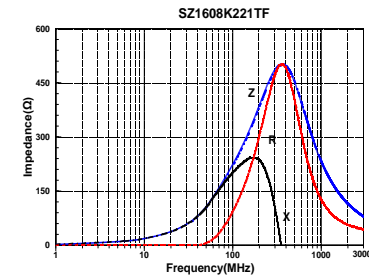
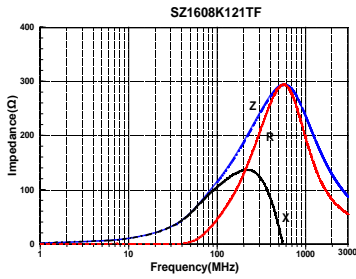
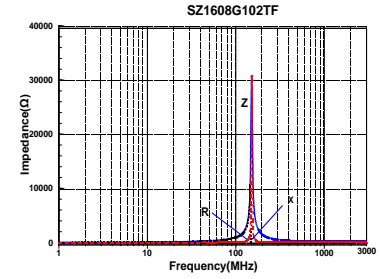
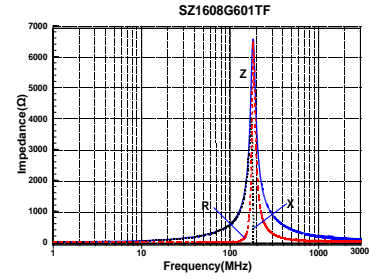
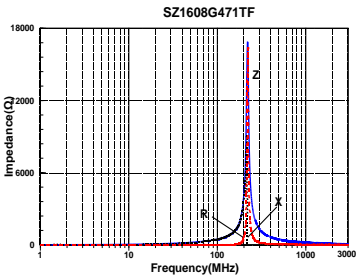
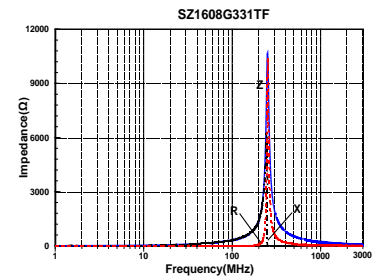
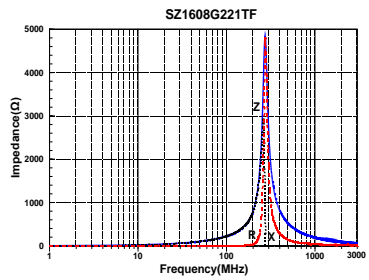
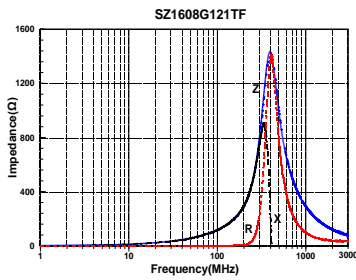
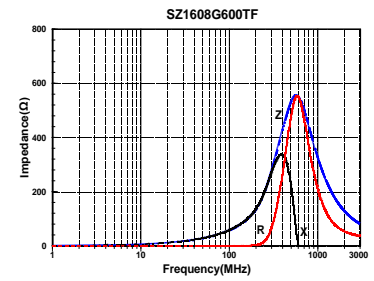
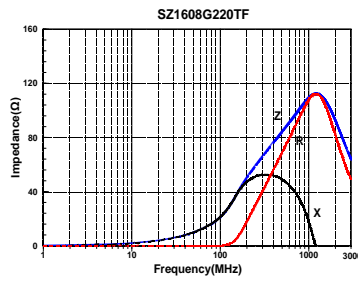
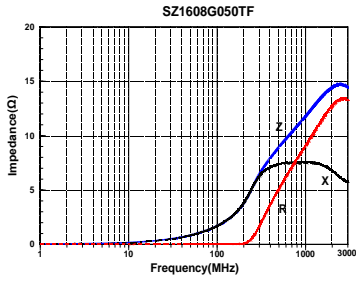

# DETAIL ELECTRICAL CHARACTERISTICS

## SZ1608 TYPE

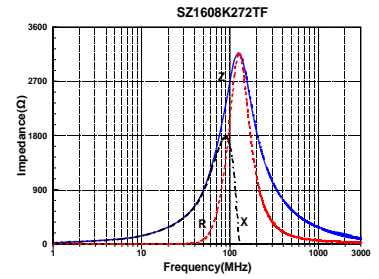
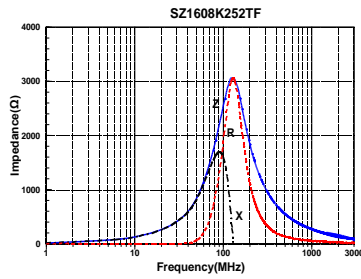
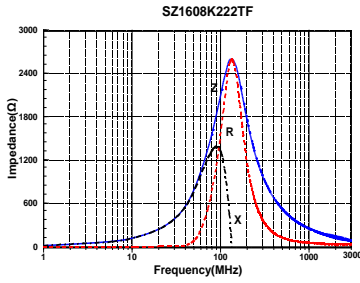

## SZ2012 TYPE

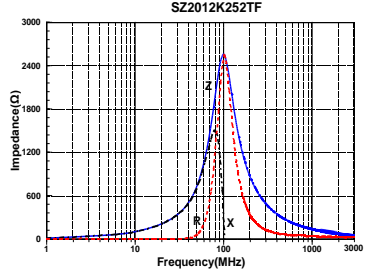
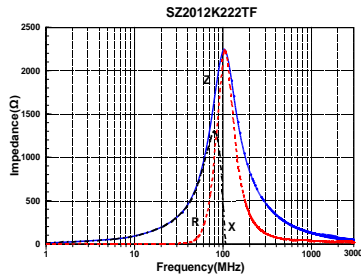
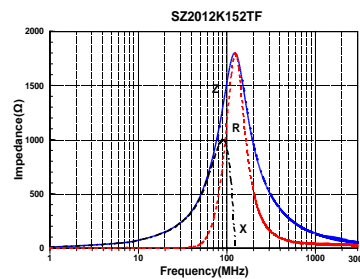
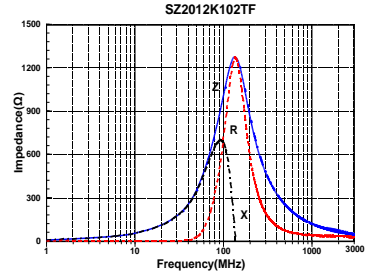
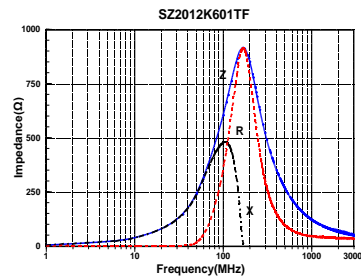
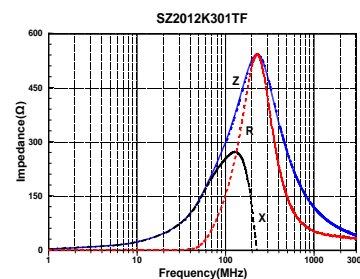
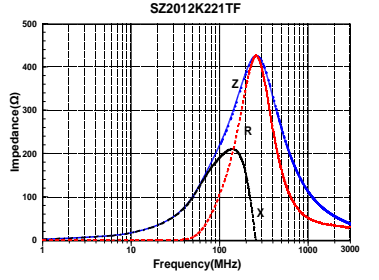
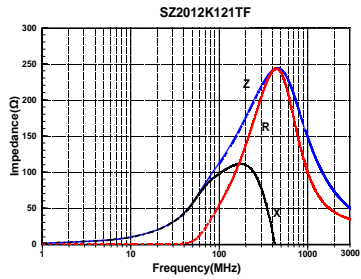
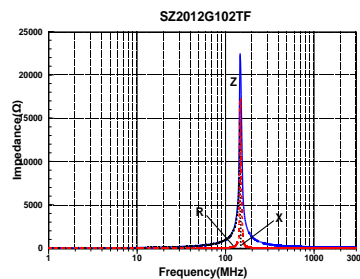
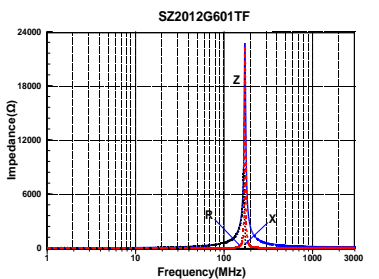
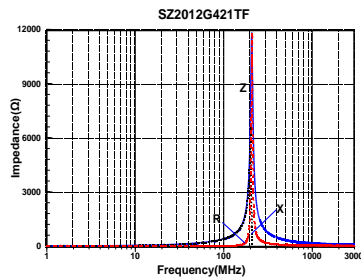
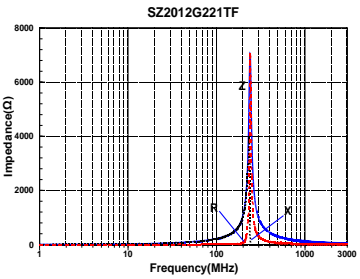
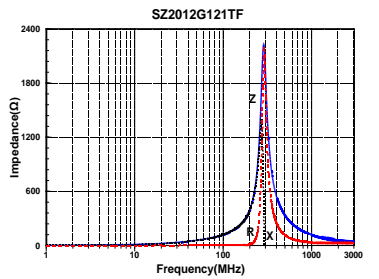
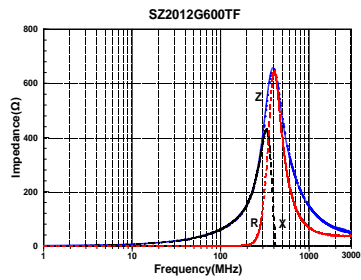
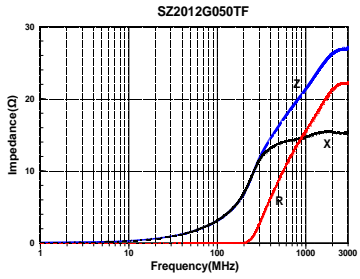



# DETAIL ELECTRICAL CHARACTERISTICS

## SZ2012 TYPE

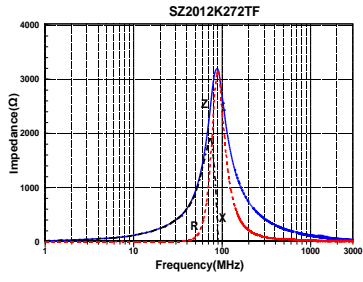

## X-ON Electronics

Largest Supplier of Electrical and Electronic Components

*Click to view similar products for [Ferrite Beads](#) category:*

*Click to view products by [Sunlord](#) manufacturer:*

Other Similar products are found below :

[CZB1EGTTP700P](#) [CZB1JGTTD152P](#) [CZB1JGTTD601P](#) [CZB2AFTTD800P](#) [CZB2AGTTD121P](#) [CZB2AGTTD601P](#) [CZB2BFTTE600P](#)  
[PE-0402FB121ST](#) [NCB0603R301TR050F](#) [NCB0805A320TR050F](#) [NCB-H1206B680TR300F](#) [SMB2.5-1TR](#) [SMB2.5R-2](#) [CZB1EGTTP121P](#)  
[CZB1JGTTD102P](#) [CZB1JGTTD121P](#) [CZB1JGTTD221P](#) [CZB2AGTTD301P](#) [CZB2BFTTE301P](#) [CZB2BFTTE601P](#) [4221R-1](#) [4221R-2](#)  
[432703041971](#) [EMI0805R-2000](#) [EMI0805R-600](#) [SBY100505T-100Y-N](#) [NCB-GH0402D121TR060F](#) [NCB-H1812D125TR150F](#)  
[CZB2AGTTD102P](#) [NCB0402P301TR005F](#) [NCB0603R152TR030F](#) [NCB0805A121TR050F](#) [NCB3312K900TR500F](#) [NCB-](#)  
[H0805A102TR150F](#) [NCB-H0805A221TR300F](#) [NCB-H1806E181TR300F](#) [NCB0402P300TR030F](#) [NCB0805A102TR040F](#)  
[NCB1806E151TR020F](#) [NCB-H0603R121TR300F](#) [NCB-H0805A220TR600F](#) [NCB-H0805A390TR400F](#) [NCB-H1206B121TR300F](#) [NCB-](#)  
[H1206B601TR200F](#) [CIM21J252NE](#) [EMI0805R-220](#) [74279250](#) [7427924](#) [CZB1JGTTD202P](#) [ABUPDE160808121Y00](#)