

SAW Duplexer

for B3 / Unbalanced / LR / 1612

Pinnacle PN: SA0316121G74AT

Key Feature:

✓ High Output Power

✓ Low Insertion Loss

1 Description

SA0316121G74AT is a high-performance Surface Acoustic Wave (SAW) duplexer optimized for FDD LTE Band 3 applications operating in the range of 1.710-1.785GHz / 1.805-1.880 GHz. It is designed to provide low insertion loss in Band 3, good isolation between TX and RX ports, and high rejection in the adjacent cellular bands for mobile devices.

SA0316121G74AT uses advanced Chip Scale Package (CSP) technology and is housed in an industry-standard, 8-pin 1.6mm x 1.2 mm package with a low profile of 0.6 mm max.

2 Package & Dimensions:

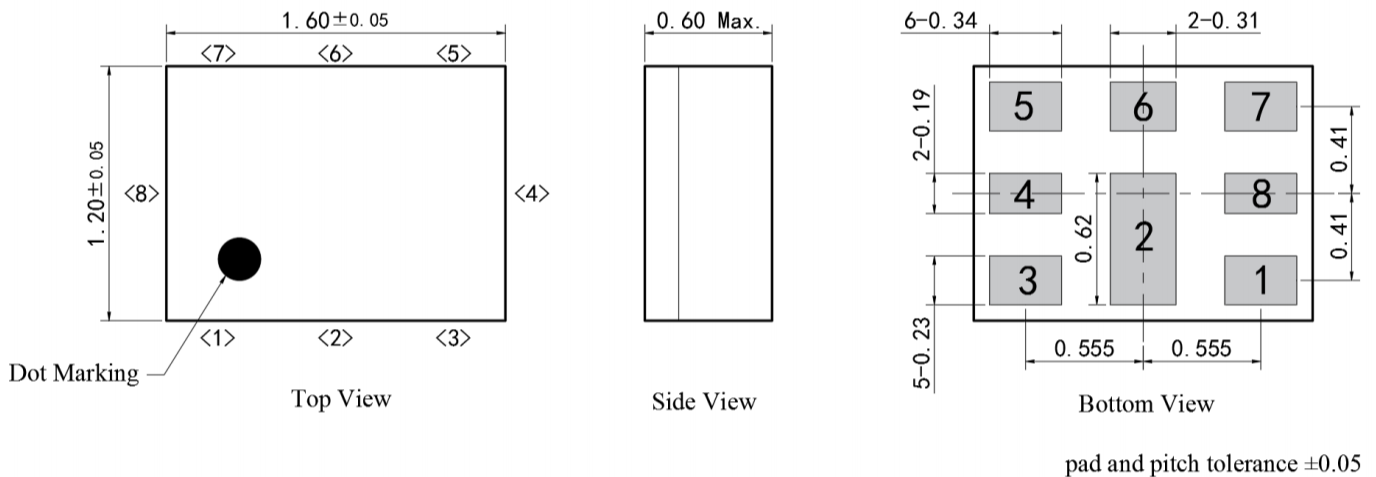

Figure 1: Drawing of Package with each tolerance range

3 Test Circuit

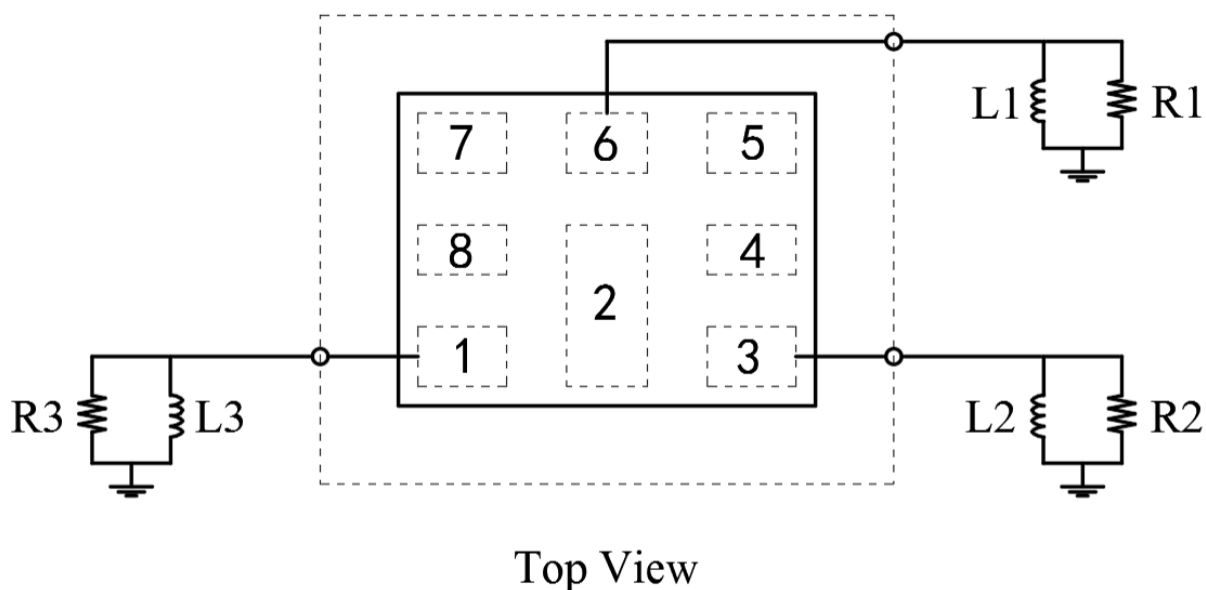

Figure 2: Schematic of matching circuit. External matching components required as below.

R1: 50 Ohm	L1: 4.3 nH
R2: 50 Ohm	L2: 9.1 nH
R3: 50 Ohm	L3: 4.7 nH

4 Pin configuration

- 1 RX
- 3 TX
- 6 Ant
- 2, 4, 5,7,8 To be grounded

5 Absolute Maximum Ratings

Parameter	Rating	Unit
Operating Temperature	-30 to +85	°C
Storage Temperature	-40 to +85	°C
Input Power@ input port	Pin=31.5dBm Continuous wave for 5000h@+50 °C	dBm
Approximate weight	2.6	mg
Moisture Sensitivity Levels	3	MSL
Maximum DC Voltage	3	V

7 Recommended Soldering Profile

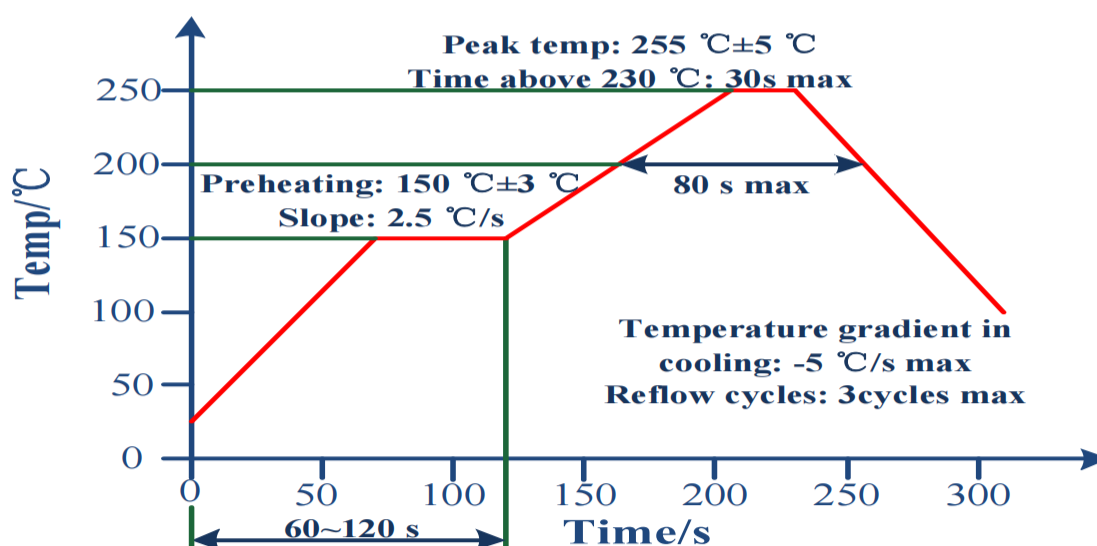

Figure 3: Recommended Reflow profile for convection and infrared soldering -lead-free solder.

7 Electrical Specifications

(At $T_a=25^{\circ}\text{C}$, unless otherwise specified, as measured on the evaluation board of SA0316121G74AT with feed line loss de-embedded.)

TX→ANT						
Parameter	Conditions	Min	Typ.	Max	Unit	
Insertion Loss	1710 - 1785 MHz	-	1.9	2.4	dB	
Passband Ripple	1710 - 1785 MHz	-	0.8	1.2	dB	
Attenuation	10 - 960 MHz	33	36	-	dB	
	1164 - 1189 MHz	30	33	-	dB	
	1559 - 1606 MHz	33	37	-	dB	
	1606 - 1680 MHz	21	24	-	dB	
	1805 - 1880 MHz	45	48	-	dB	
	1920 - 1980 MHz	30	33	-	dB	
	2110 - 2170 MHz	35	40	-	dB	
	2400 - 2500 MHz	28	32	-	dB	
	2620 - 2690 MHz	25	31	-	dB	
	3420 - 3570 MHz	10	13	-	dB	
	4900 - 5850 MHz	8	11	-	dB	
	5130 - 5355 MHz	10	15	-	dB	
VSWR(TX)	1710 - 1785 MHz	-	1.5	2.1	-	
VSWR(ANT)	1710 - 1785 MHz	-	1.5	2.1	-	

ANT→RX					
Parameter	Conditions	Min	Typ.	Max	Unit
Insertion Loss	1805 - 1880 MHz	-	3.0	3.5	dB
Passband Ripple	1805 - 1880 MHz	-	1.0	1.8	dB
Attenuation	10 - 1710 MHz	35	40	-	dB
	718 - 748 MHz	50	55	-	dB
	814 - 849 MHz	50	55	-	dB
	832 - 862 MHz	51	56		dB
	880 - 915 MHz	45	53		dB
	1615 - 1690 MHz	35	40		dB
	1710 - 1785 MHz	40	45		dB
	1920 - 2400 MHz	25	30		dB
	2400 - 2500 MHz	30	36		dB
	2500 - 2570 MHz	36	40		dB
	2575 - 3515 MHz	37	39		dB
	3515 - 3760 MHz	35	38		dB
	4900 - 5950 MHz	28	33		dB
VSWR(ANT)	1805 - 1880 MHz	-	1.7	2.1	-
VSWR(RX)	1805 - 1880 MHz	-	1.6	2.0	-

TX→RX					
Parameter	Conditions	Min	Typ.	Max	Unit
Isolation	1710 - 1785 MHz	50	52	-	dB
	1805 - 1880 MHz	50	53	-	dB
	1574 - 1577 MHz	50	62	-	dB
	3420 - 3570 MHz	45	47	-	dB
	5130 - 5355 MHz	37	40	-	dB

8 Frequency Characteristics

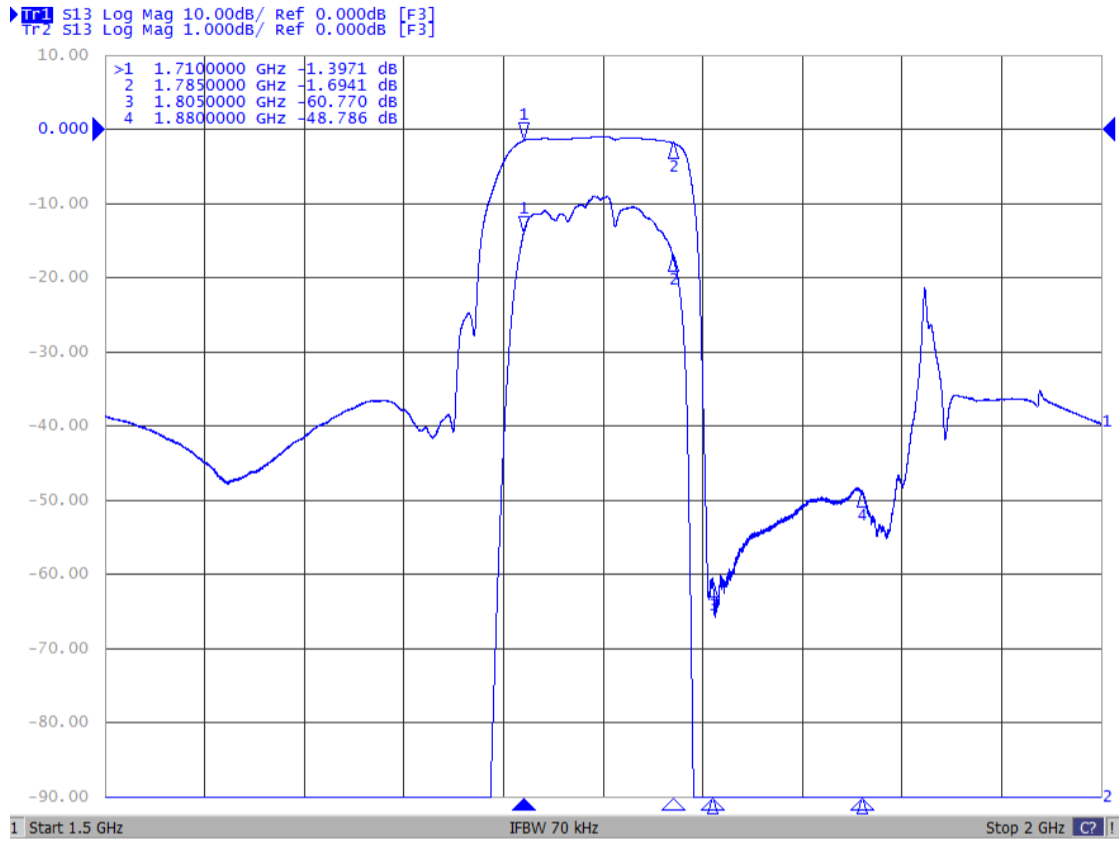

Figure 4: TX→ANT

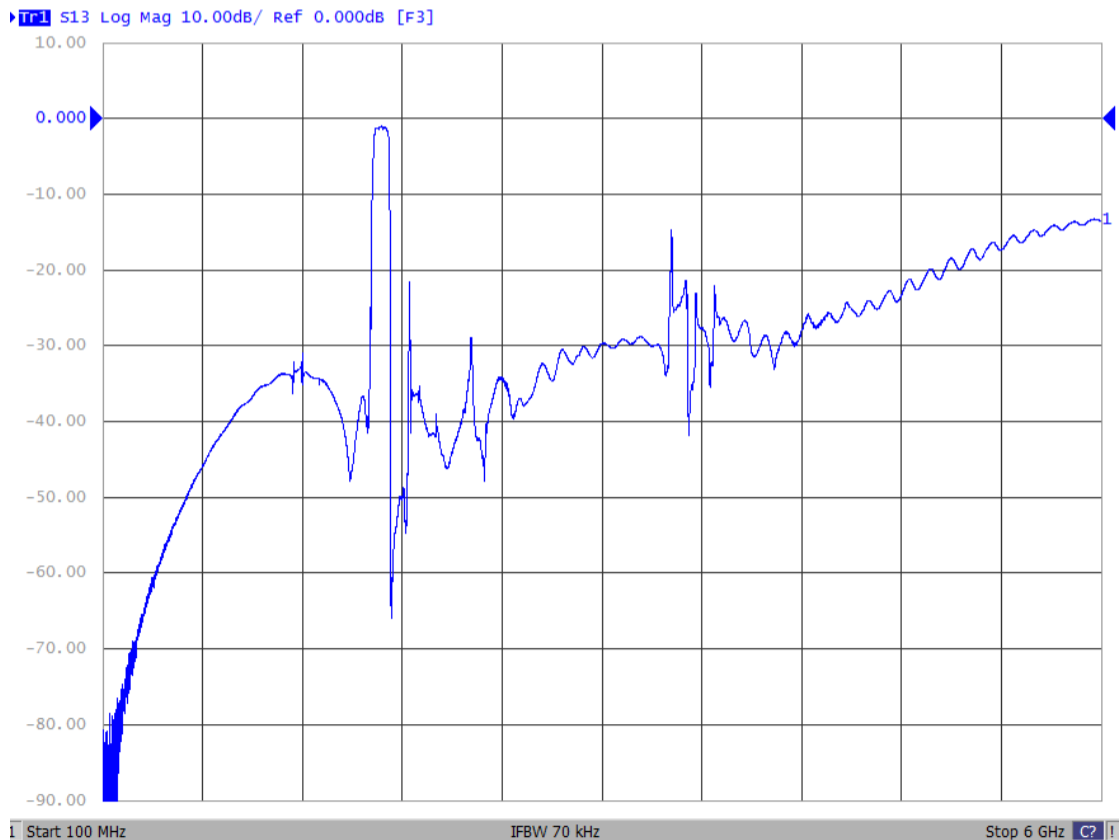

Figure 5: TX→ANT (Wide Band)

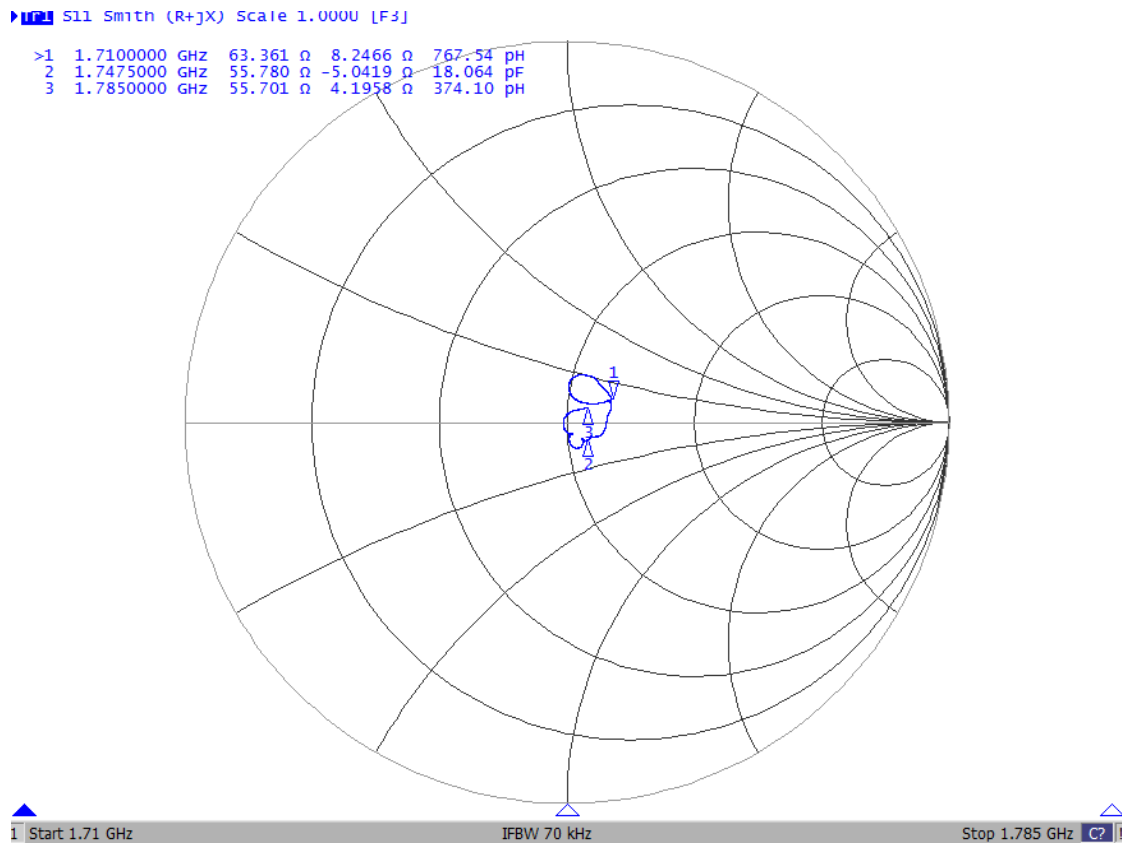

Figure 6: Smith for ANT

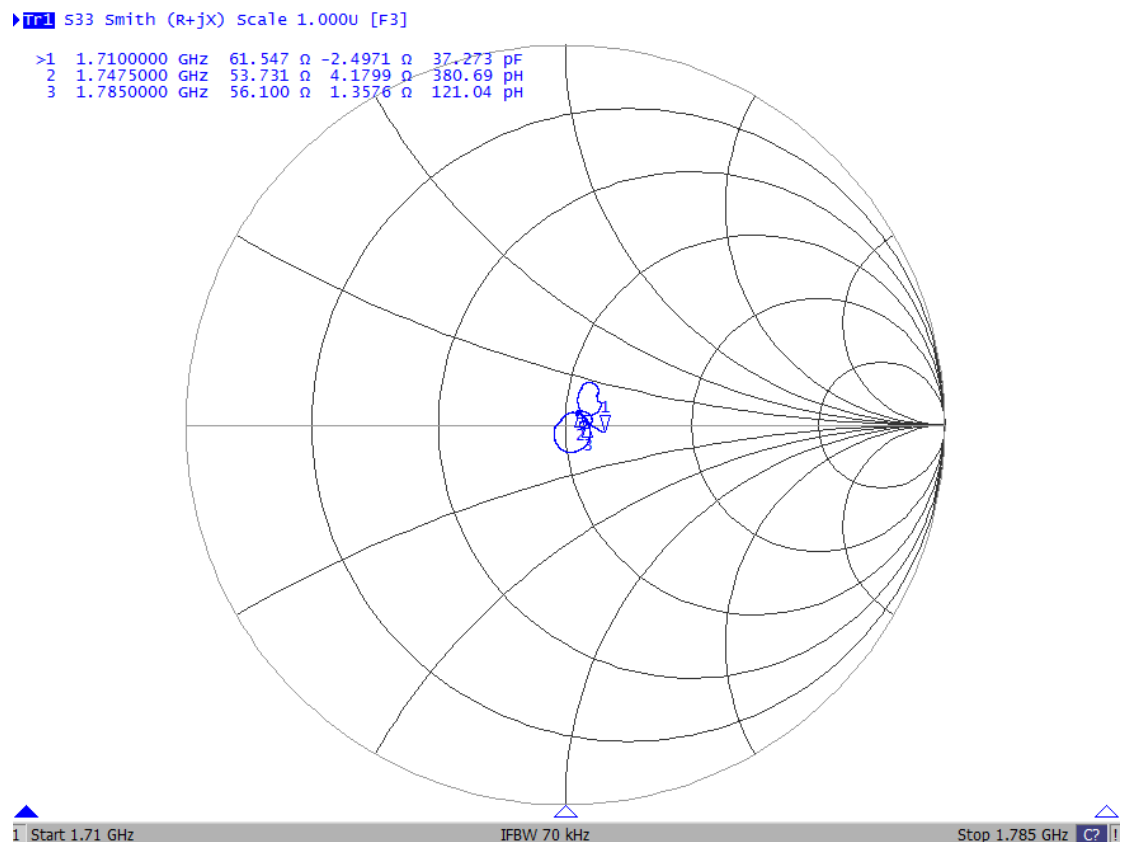
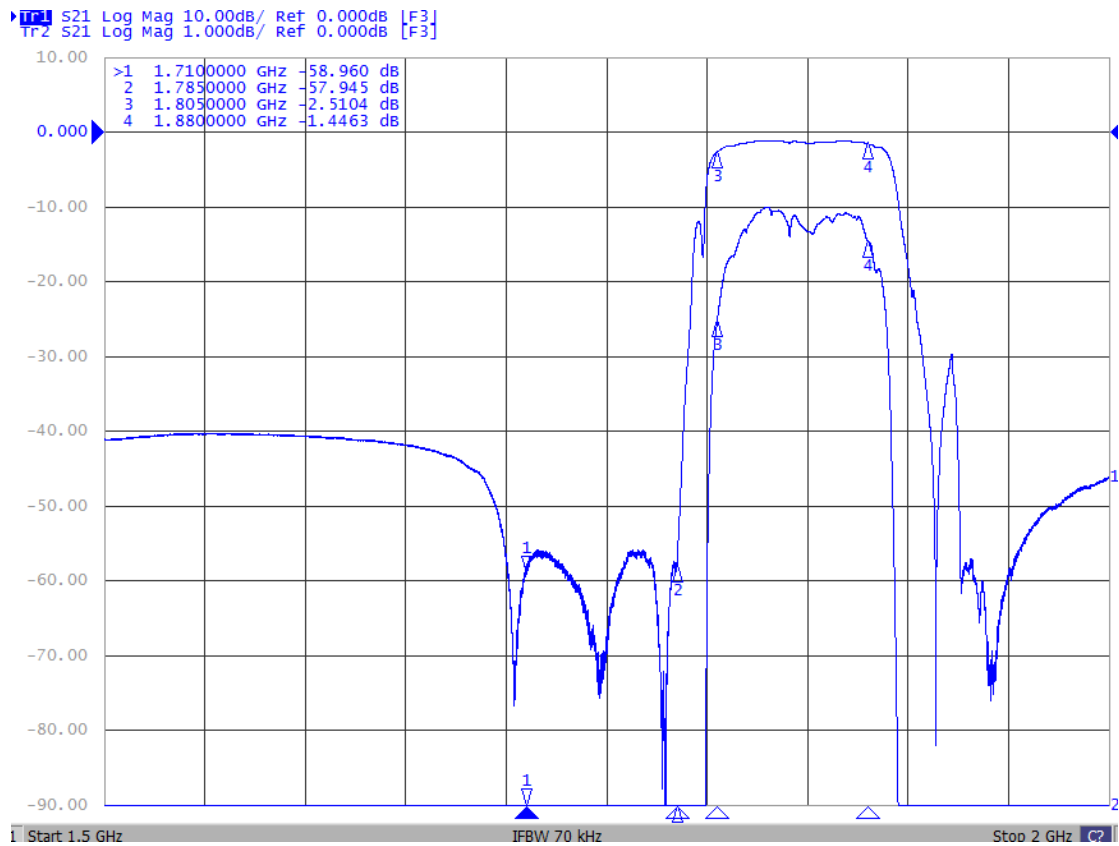
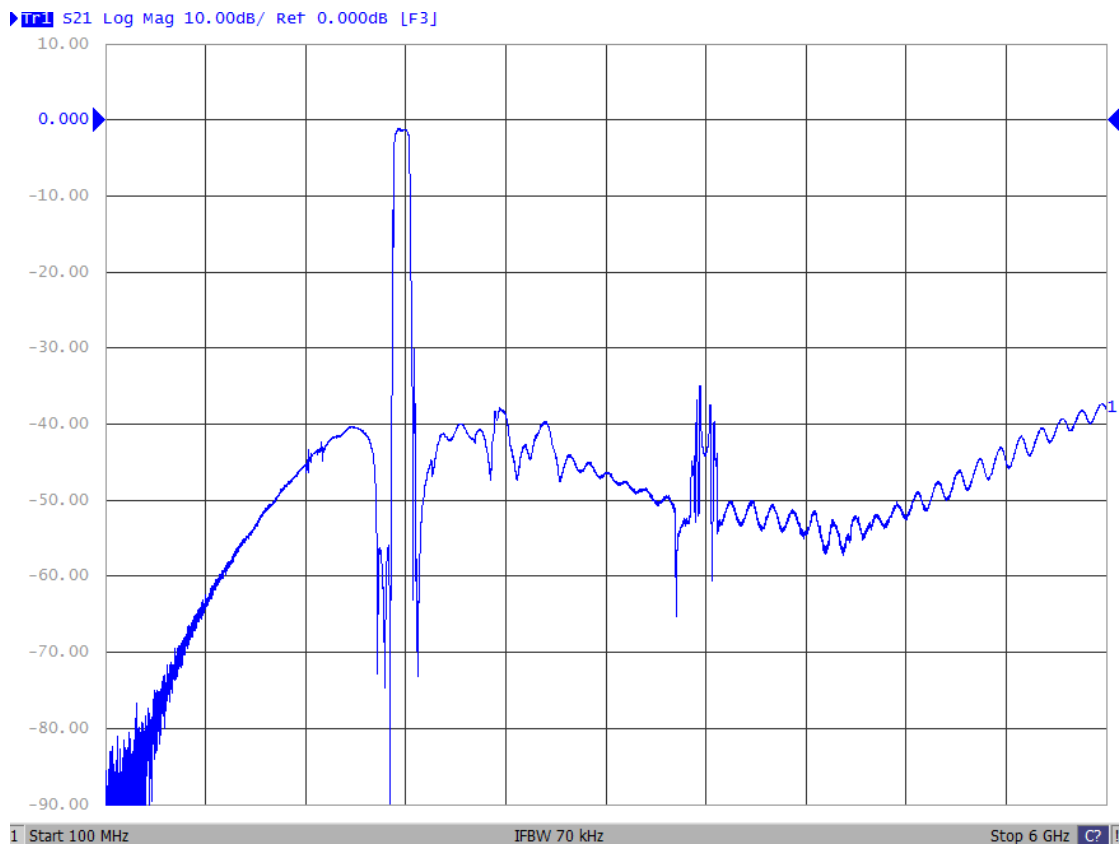
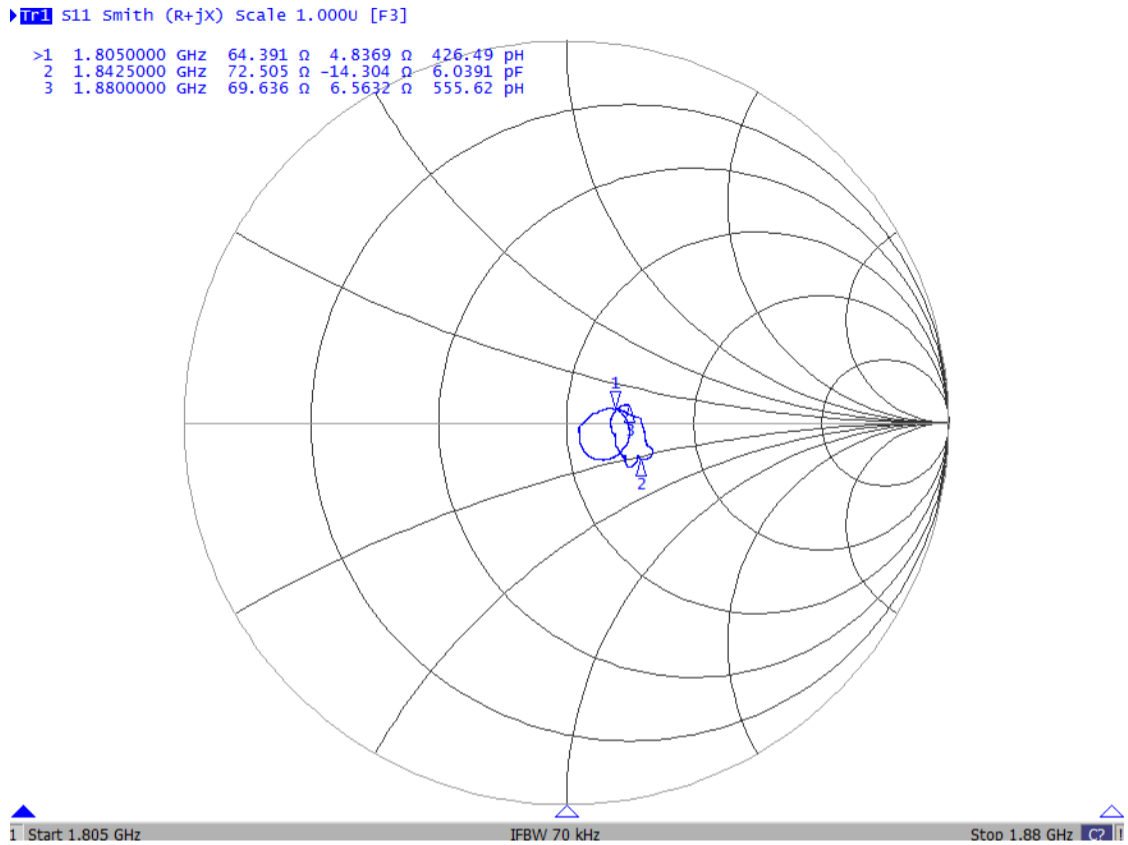
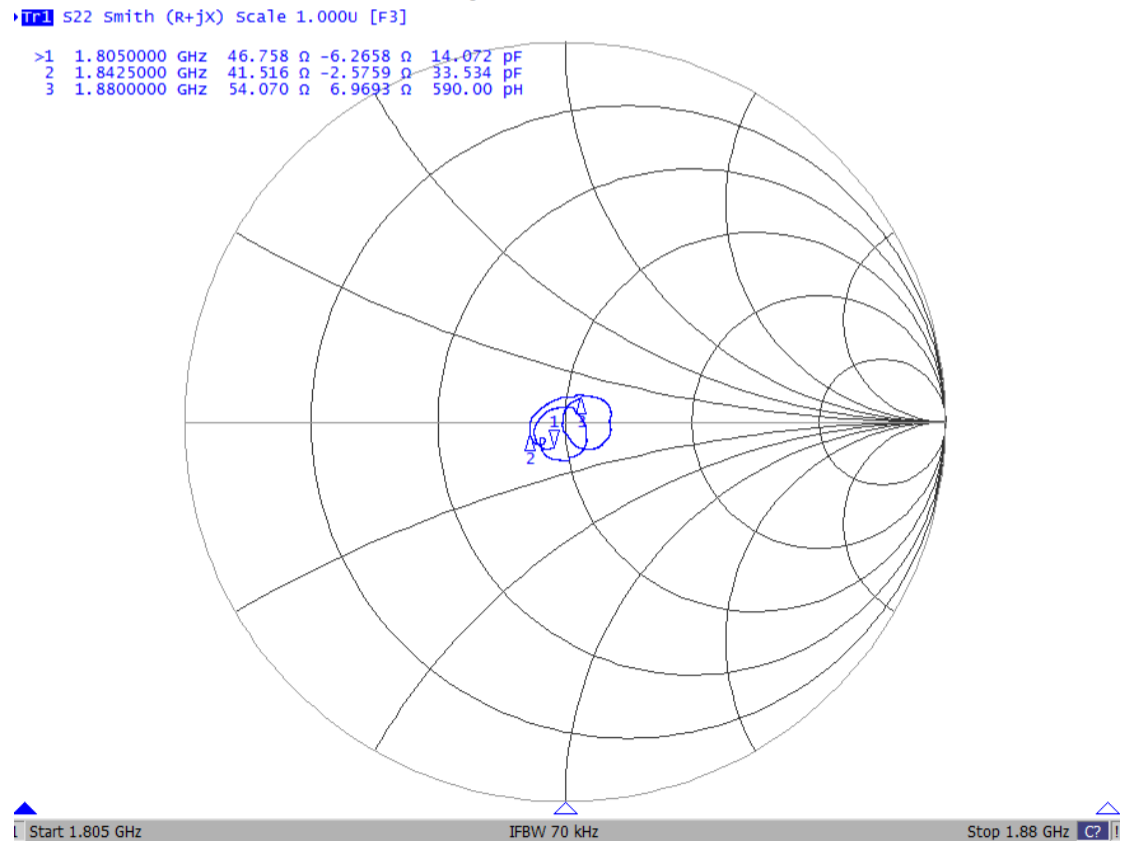

Figure 7: Smith for TX

Figure 8: ANT→RX

Figure 9: ANT→RX (Wide Band)

Figure 10: Smith for ANT

Figure 11: Smith for RX

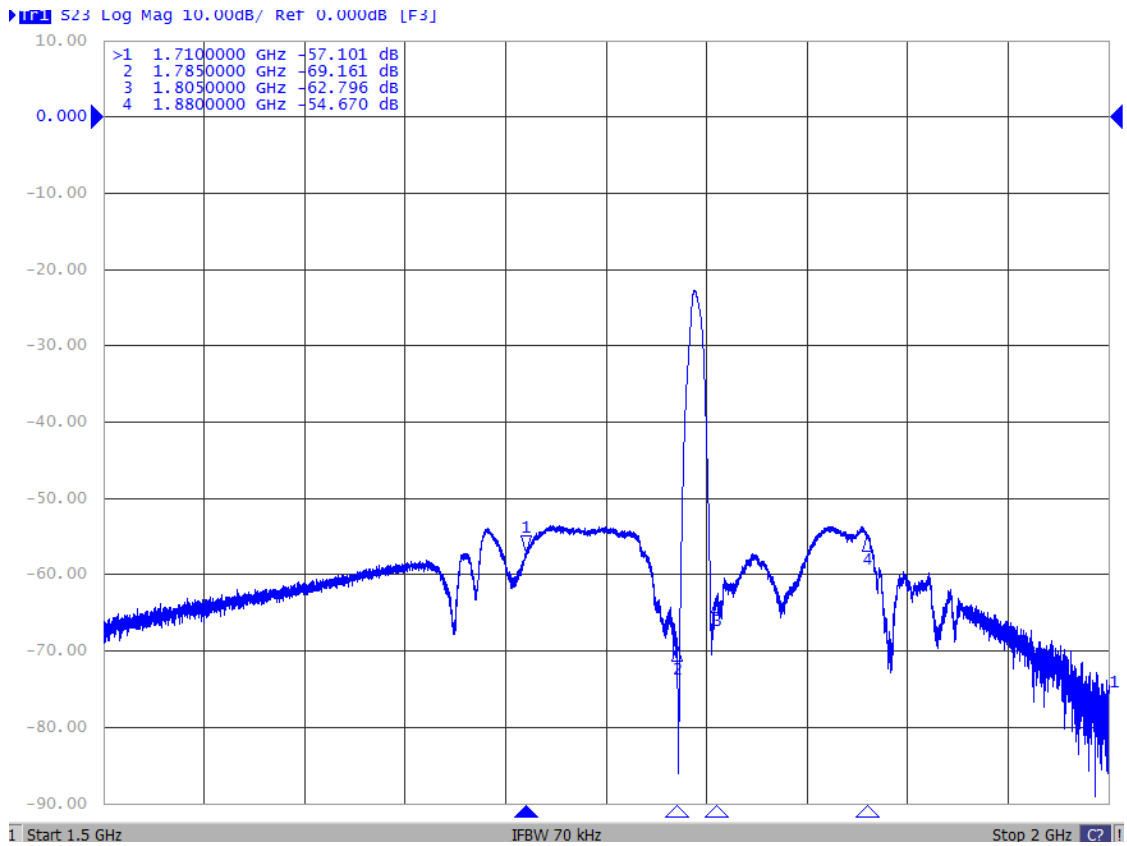

Figure 12: TX→RX

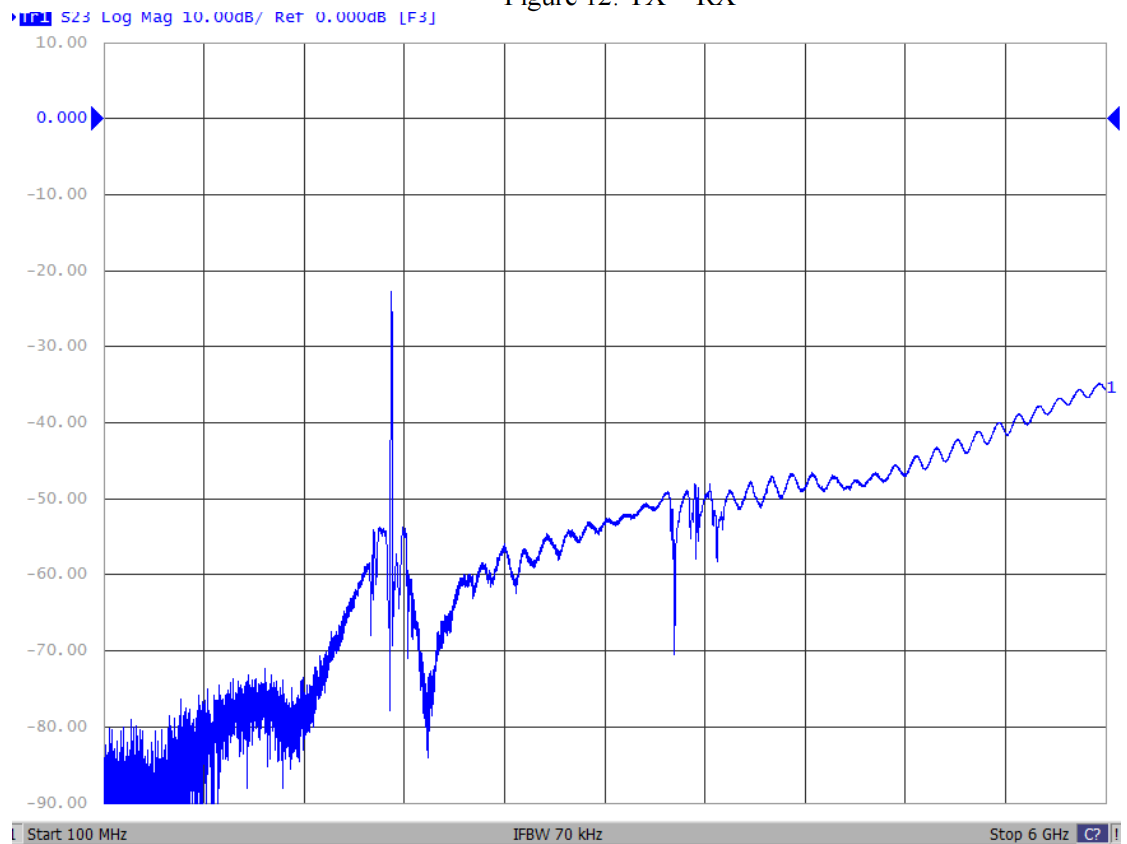

Figure 13: TX→RX (Wide Band)

9 Packaging

9.1 Tape

Tensile Strength of Carrier Tape: Carrier tape 10N or more; Cover tape 5N or more. Packaging quantities: 5000 PCS / Reel.

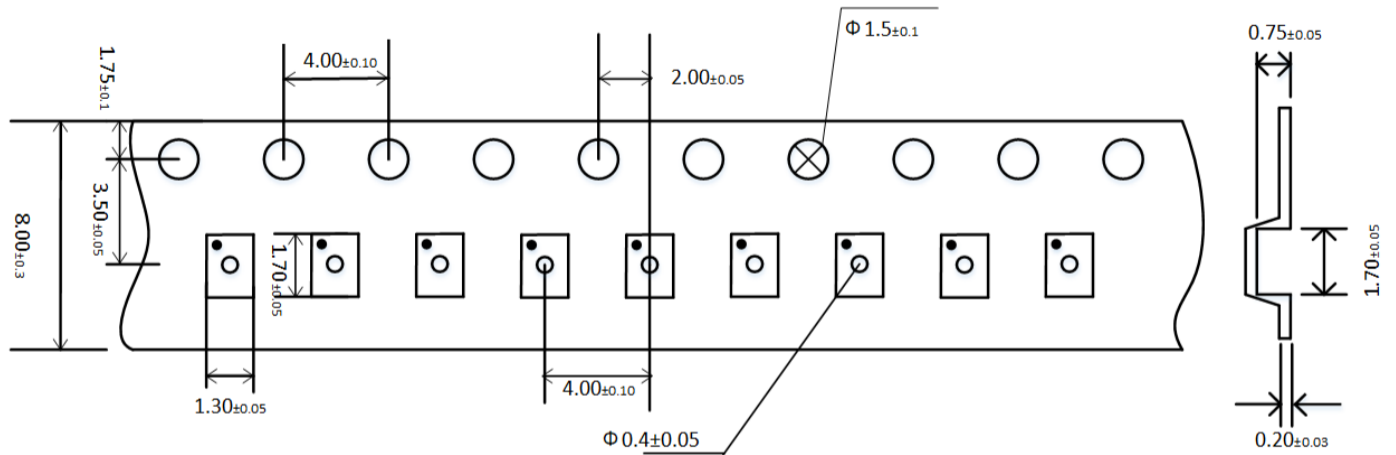

Figure 14: Drawing of tape with tape dimensions according above (mm).

9.2 Reel with diameter of 178mm

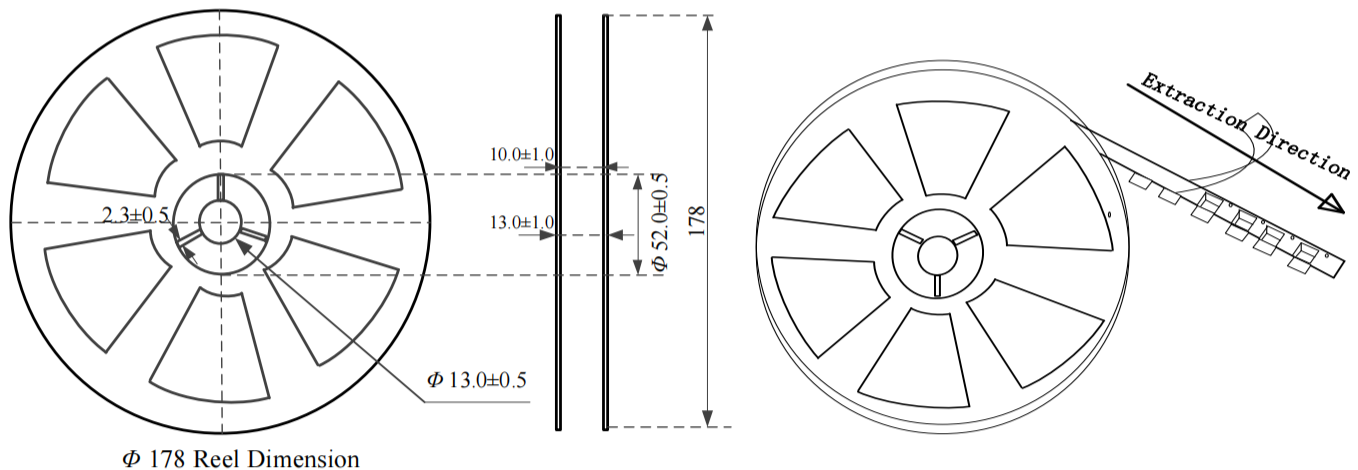

Figure 15: Drawing of reel with diameter of 178mm.

X-ON Electronics

Largest Supplier of Electrical and Electronic Components

Click to view similar products for [Signal Conditioning](#) category:

Click to view products by [Sunltech](#) manufacturer:

Other Similar products are found below :

[PD0409J5050S2HF](#) [HHS-109-PIN](#) [AFS14A35-1591.50-T3](#) [JP510S](#) [LFB322G45SN1A504](#) [SF2159E](#) [FM-104-PIN](#) [CER0813B](#)
[MAPDCC0005](#) [3A325](#) [BD0810N50100AHF](#) [DC0710J5005AHF](#) [DC2327J5005AHF](#) [LFL15869MTC1B787](#) [X3C19F1-20S](#)
[CDBLB455KCAX39-B0](#) [RF1353C](#) [051157-0000](#) [PD0922J5050D2HF](#) [600S150FTRB](#) [1E1305-3](#) [1F1304-3S](#) [TP-103-PIN](#)
[BD1222J50200AHF](#) [BD1722J50100AHF](#) [2450DP39K5400E](#) [BD0810J50150AHF](#) [BD1722J50200AHF](#) [DS-327-PIN](#) [MACP-008125-](#)
[CK07F0](#) [DS-329-PIN](#) [DS-313-PIN](#) [TP-104-PIN](#) [TP-101-PIN](#) [HH-128-PIN](#) [8594810000](#) [T-1000-N](#) [JP506S](#) [XC0900P-10S](#) [XC0900B-30S](#)
[CHE1260-QAG](#) [11305-10](#) [5962-9091202MXA](#) [3A412S](#) [X3C06A4-03S](#) [B39000Z3410A4](#) [DSS-333-PIN](#) [PD2425J5050S2HF](#)
[B39242B4360P810](#) [B39781B8005P810](#)