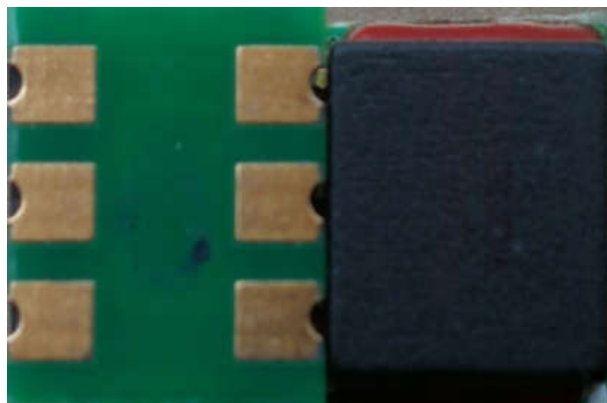
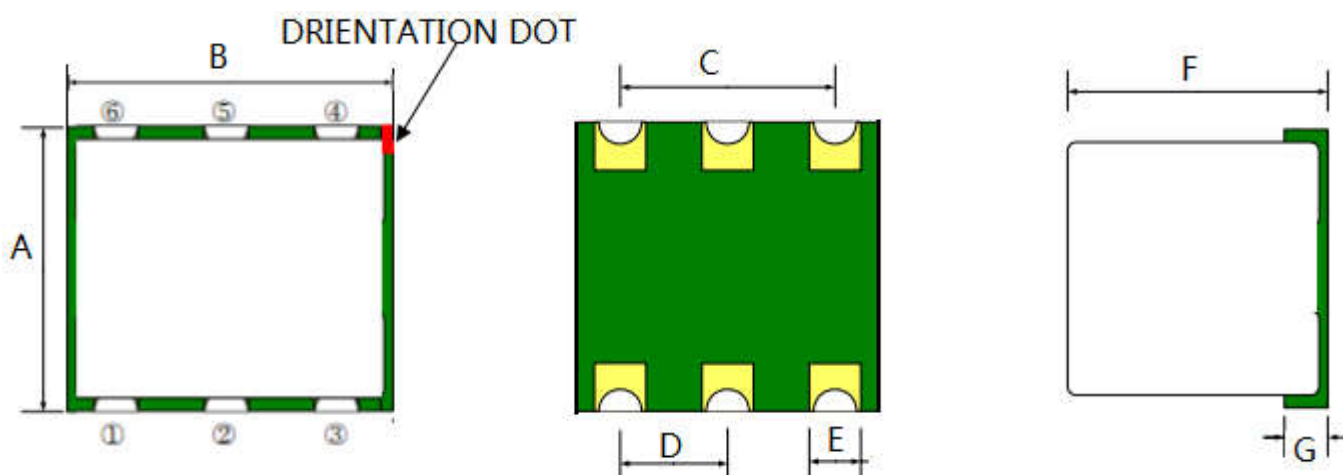

RF Balun Transformer, 1: 4CT Flux Coupled Transformer
Features:

- ◆ 50Ω Impedance
- ◆ Equivalent to: ADTT4-1
- ◆ Frequency: 0.3 to 125 MHz
- ◆ RF power: 0.50W
- ◆ DC current: 30mA
- ◆ Operating temperature range: -20°C to +85°C
- ◆ Storage temperature range: -55°C to +100°C

Applications:

- ◆ For impedance matching
- ◆ For balanced amplifier

Dimension Diagram (Unit:mm) :

A:7.2±0.2 B:9.0±0.2 C:5.1±0.1 D:2.6±0.1 E:1.6±0.1 F:5.5±0.2 G:0.6±0.1

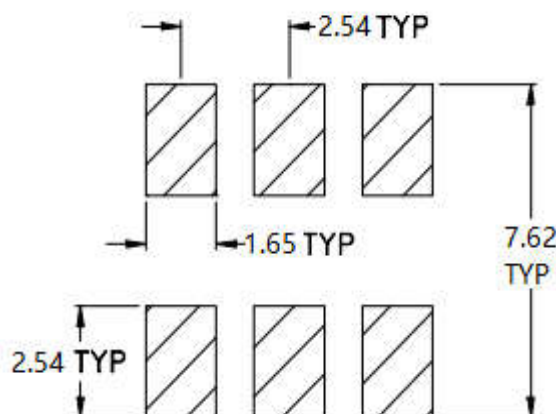
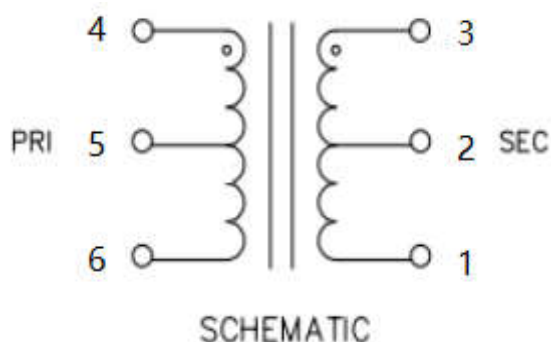
Electrical structure:
Recommended layout:

Pin configuration

Pin no.	Function
1	Secondary (Output 2)
2	Centre tap (Ground)
3	Secondary dot (Output 1)
4	Primary dot (Input)
6	Primary (Ground)

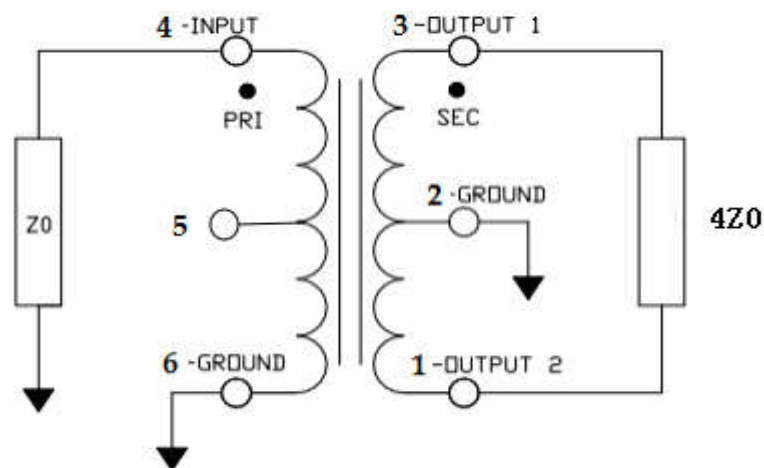
Application circuit :

Electrical Specifications: $T_A = 25^\circ\text{C}$ $Z_0 = 50\Omega$

Parameter	Test Conditions	Units	Min	Typ	Max
Main line Loss(out1)	0.3-125MHz	dB	—	0.5	1.0
Main line Loss(out2)	0.3-125MHz	dB	—	0.3	1.0
Amplitude Balance	0.3-125MHz	dB	—	0.2	± 0.5
Phase Balance	0.3-125MHz	Degrees	—	0.1	± 5.0
Input Return Loss	0.3-125MHz	dB	10.0	28.0	—

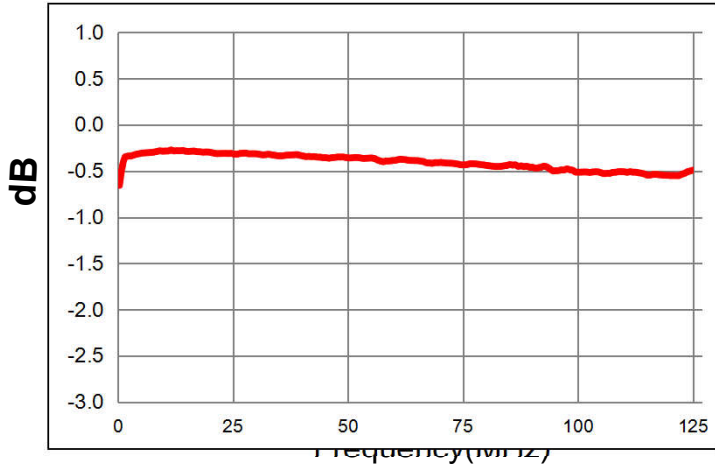
Main line Loss(out1)

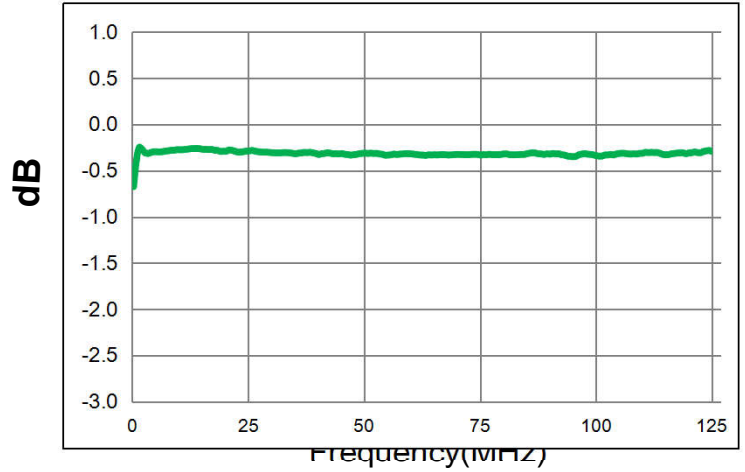

Main line Loss(out2)



Amplitude Balance

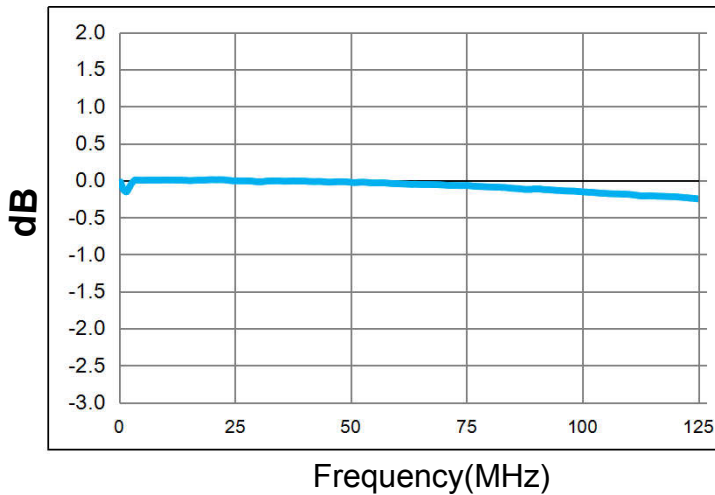

Phase Balance

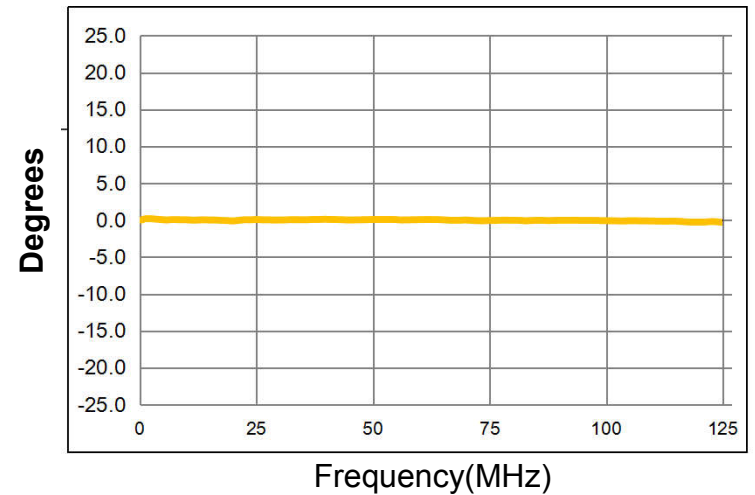

Input Return Loss

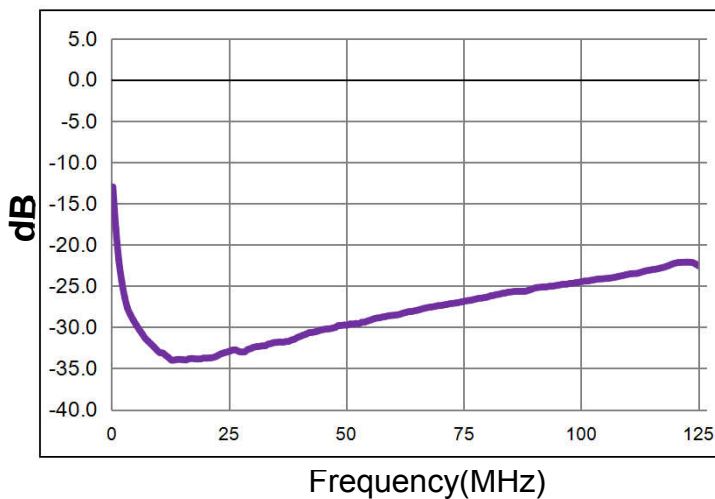

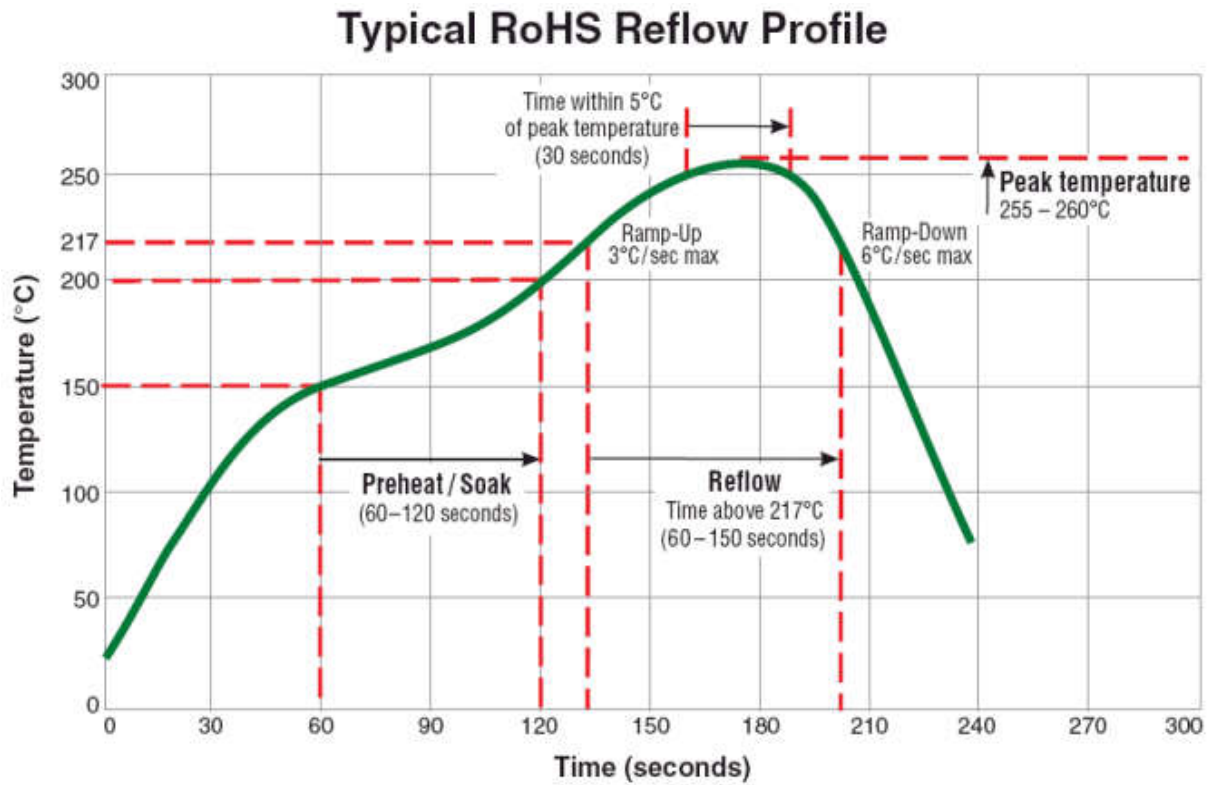
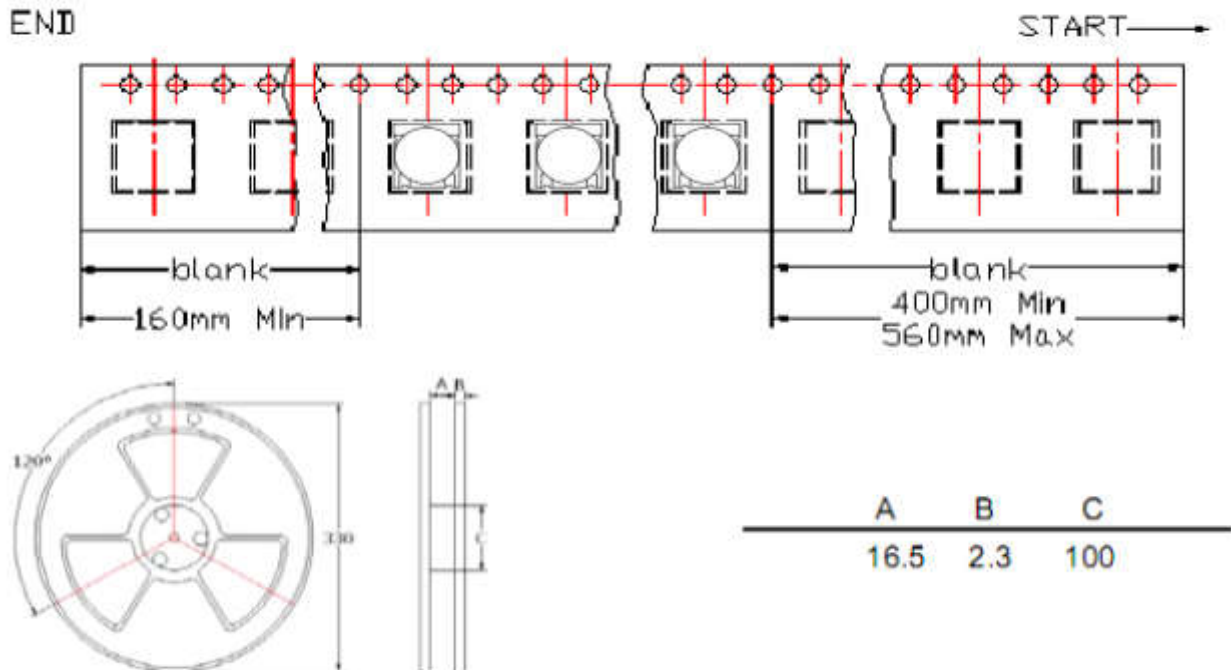
Recommended Soldering Temperature Graph:

Packging Dimension For Caeier Tape(UNIT:mm):

QUANTITY

1000 PCS/Reel

3Reels/Middle Carton

5 Middle Cartons/Big Carton/12000pcs

X-ON Electronics

Largest Supplier of Electrical and Electronic Components

Click to view similar products for [Signal Conditioning](#) category:

Click to view products by [Sunltech](#) manufacturer:

Other Similar products are found below :

[PD0409J5050S2HF](#) [HHS-109-PIN](#) [AFS14A35-1591.50-T3](#) [JP510S](#) [LFB322G45SN1A504](#) [SF2159E](#) [FM-104-PIN](#) [CER0813B](#)
[MAPDCC0005](#) [3A325](#) [BD0810N50100AHF](#) [DC0710J5005AHF](#) [DC2327J5005AHF](#) [LFL15869MTC1B787](#) [X3C19F1-20S](#)
[CDBLB455KCAX39-B0](#) [RF1353C](#) [051157-0000](#) [PD0922J5050D2HF](#) [600S150FTRB](#) [1E1305-3](#) [1F1304-3S](#) [TP-103-PIN](#)
[BD1222J50200AHF](#) [BD1722J50100AHF](#) [2450DP39K5400E](#) [BD0810J50150AHF](#) [BD1722J50200AHF](#) [DS-327-PIN](#) [MACP-008125-](#)
[CK07F0](#) [DS-329-PIN](#) [DS-313-PIN](#) [TP-104-PIN](#) [TP-101-PIN](#) [HH-128-PIN](#) [8594810000](#) [T-1000-N](#) [JP506S](#) [XC0900P-10S](#) [XC0900B-30S](#)
[CHE1260-QAG](#) [11305-10](#) [5962-9091202MXA](#) [3A412S](#) [X3C06A4-03S](#) [B39000Z3410A4](#) [DSS-333-PIN](#) [PD2425J5050S2HF](#)
[B39242B4360P810](#) [B39781B8005P810](#)