

High Current Chip Ferrite Bead

◆ Features

- 1、 Internal silver printed layers and magnetic shielded structures to minimize crosstalk
- 2、 Large withstand current (allowable current: up to 6A)
- 3、 Can be used in a wide range of frequency to suppress EMI
- 4、 Three types material and wide range of impedance values for various applications
- 5、 RoHS Compliant.



◆ Application

- 1、 High current DC power lines.
- 2、 Noise suppression for power line or large current signal of electric equipments such as computers and peripheral devices, DVD cameras, LCD TVs, communication equipments, OA equipments, etc.

◆ PRODUCT IDENTIFICATION

SBH 3216 S 600 U S P
(1) (2) (3) (4) (5) (6) (7)

- (1) Series Type
- (2) Chip Size (mm) :Length X Width
- (3) Material Code
- (4) Nominal Impedance:600=60Ω;601=600Ω;
102=1000Ω
- (5) Rated Current: E=300mA;F=500mA;J=800mA
L =1000mA; M=1500mA;
N=2000mA; P=2500mA;
Q=3000mA; R=4000mA;
U=5000mA W=6000mA.
- (6) Company Code
- (7) Packaging:P–Embossed paper tape, 7" reel
E- Embossed plastic tape, 7" reel

◆ Dimensions Unit: mm

Size(EIA)	L	W	T	E
3216(1206)	3.20±0.20	1.60±0.20	0.9±0.20	0.50±0.30

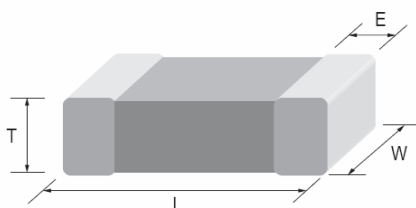

◆ Specifications

Part Number	Impedance (Ω)	Test Freq. (MHz)	DCR Max. (Ω)	Rated Current (mA)
SBH3216 Series				
SBH3216S100WSP	10±25%	100	0.010	6000
SBH3216S300WSP	30±25%	100	0.012	6000
SBH3216S600USP	60±25%	100	0.015	5000
SBH3216S750RSP	75±25%	100	0.020	4000
SBH3216S900QSP	90±25%	100	0.025	3000
SBH3216S121QSP	120±25%	100	0.030	3000
SBH3216S181QSP	180±25%	100	0.037	3000
SBH3216S221QSP	220±25%	100	0.040	3000
SBH3216S301QSP	300±25%	100	0.040	3000
SBH3216S601NSP	600±25%	100	0.100	2000
SBH3216S102LSP	1000±25%	100	0.300	1000

◆ General Technical Data

Operating Temperature Range	-55°C ~ +125°C
Storage Condition	Less than 40°C and 70% RH
Soldering Method	Reflow or Wave Soldering

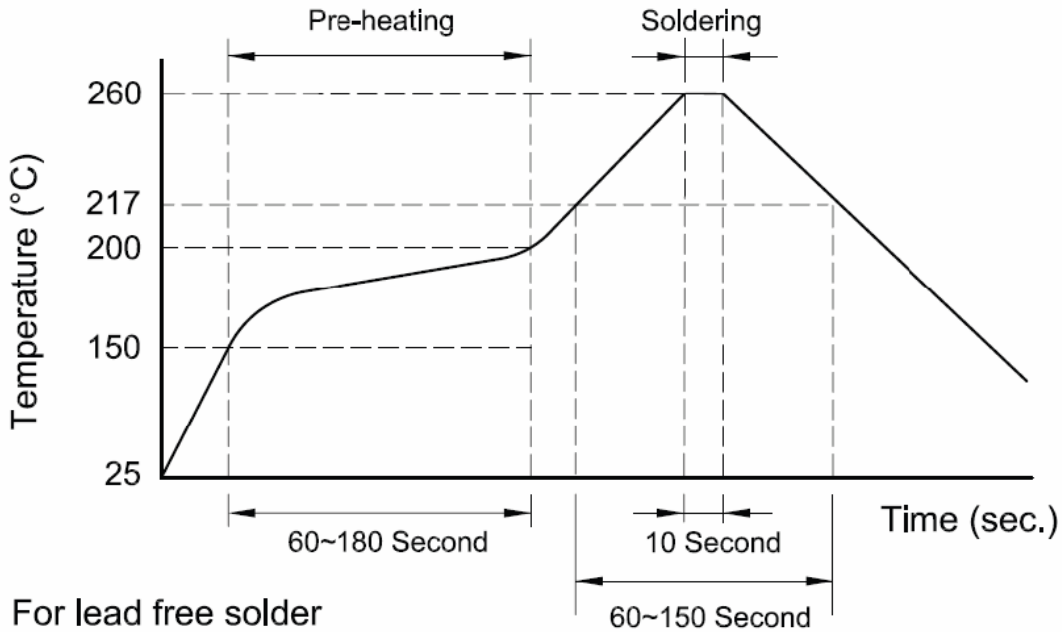
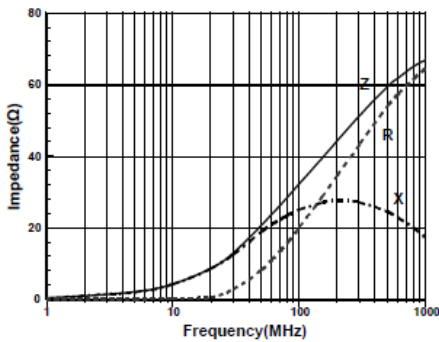
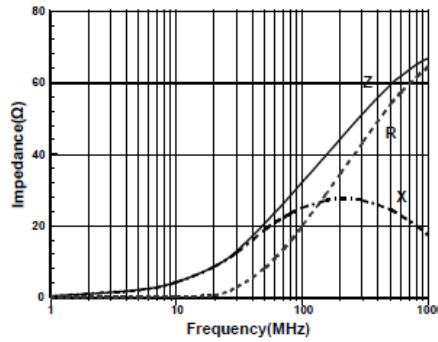
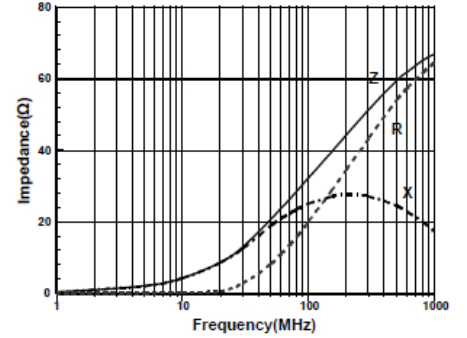
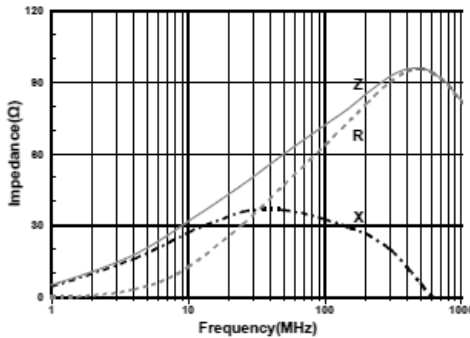
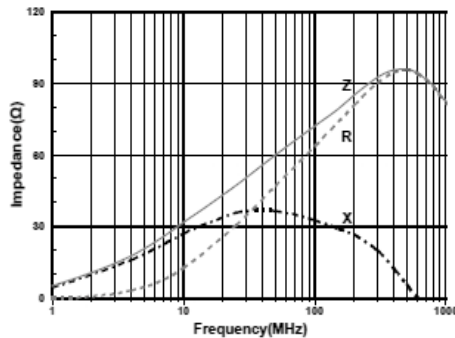
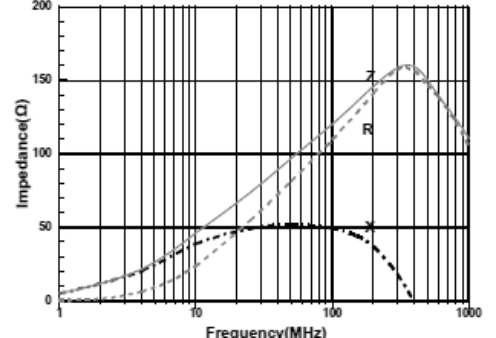
◆ Recommended Soldering Conditions

◆ Characteristics
SBH3216 TYPE
SBH3216S100WSP

SBH3216S300WSP

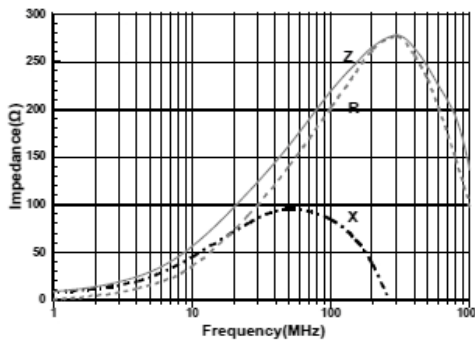
SBH3216S600USP

SBH3216S750RSP

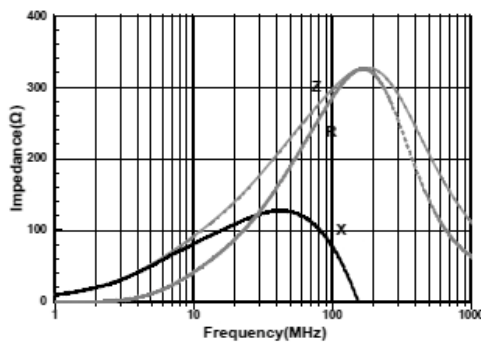
SBH3216S900QSP

SBH3216S121QSP

◆ Characteristics

SBH3216S181QSP



SBH3216S221QSP



SBH3216S301QSP

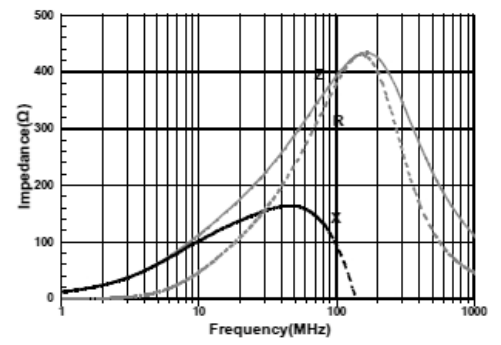

SBH3216S601NSP

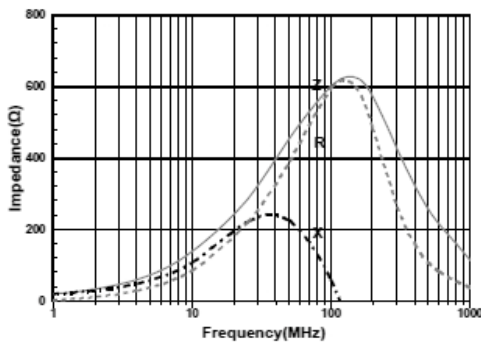

SBH3216S102LSP

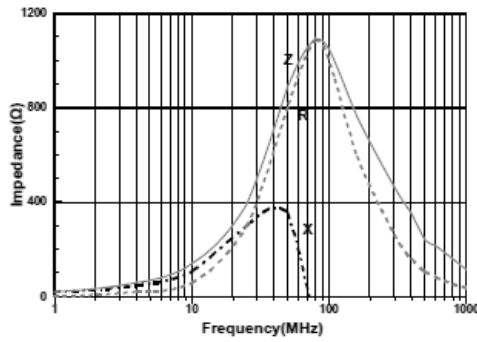

◆ Packaging

Tape Carrier Packaging:

Packaging code: T

- a. Tape carrier packaging are specified in attached figure
- b. Tape carrier packaging quantity please see the following table

Type	3216(1206)
T(mm)	0.9±0.1
Tape	Paper Tape
Quantity	4K

(1) Taping Drawings (Unit: mm)

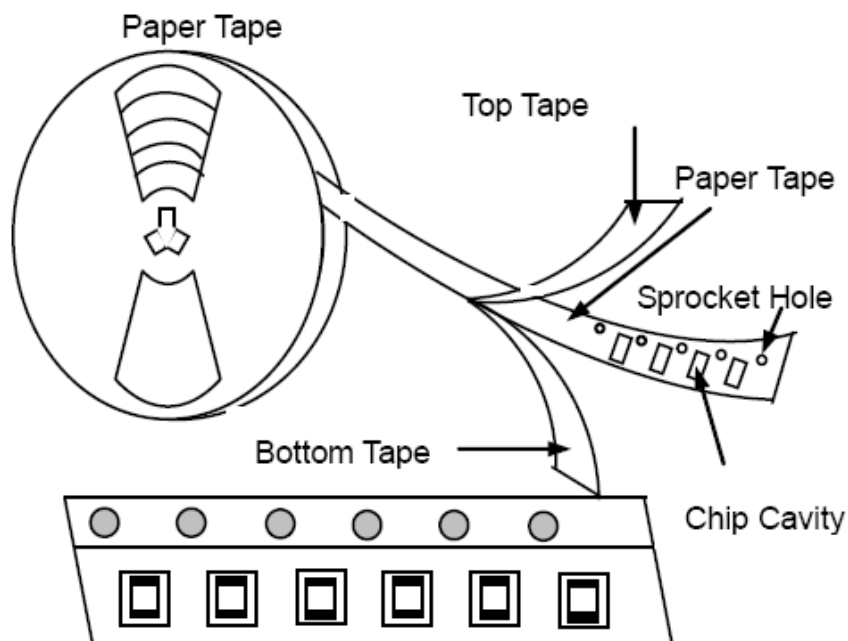

Remark: The sprocket holes are to the right as the tape is pulled toward the user.

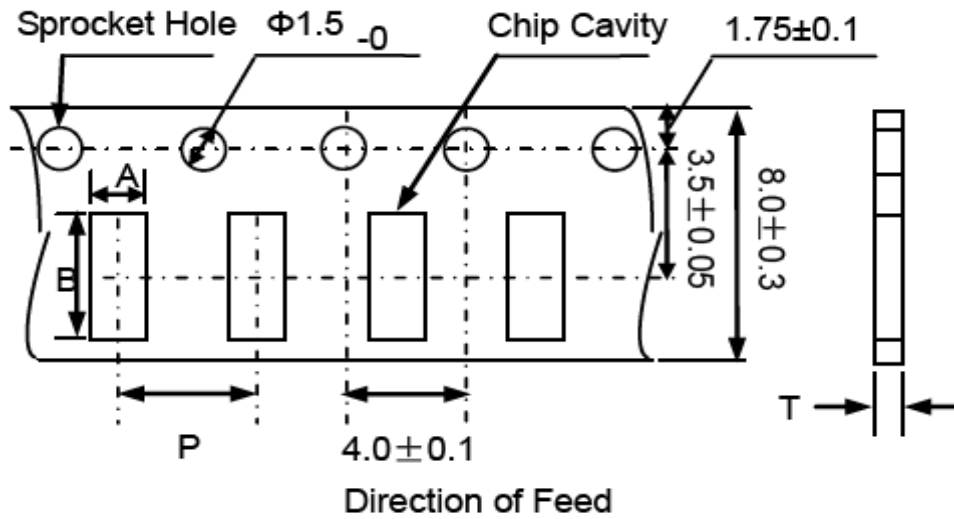
(2) Taping Dimensions (Unit: mm)

Paper Tape

Type	A	B	P	T max
3216(1206)	1.9 ± 0.2	3.5 ± 0.2	4.0 ± 0.2	0.8

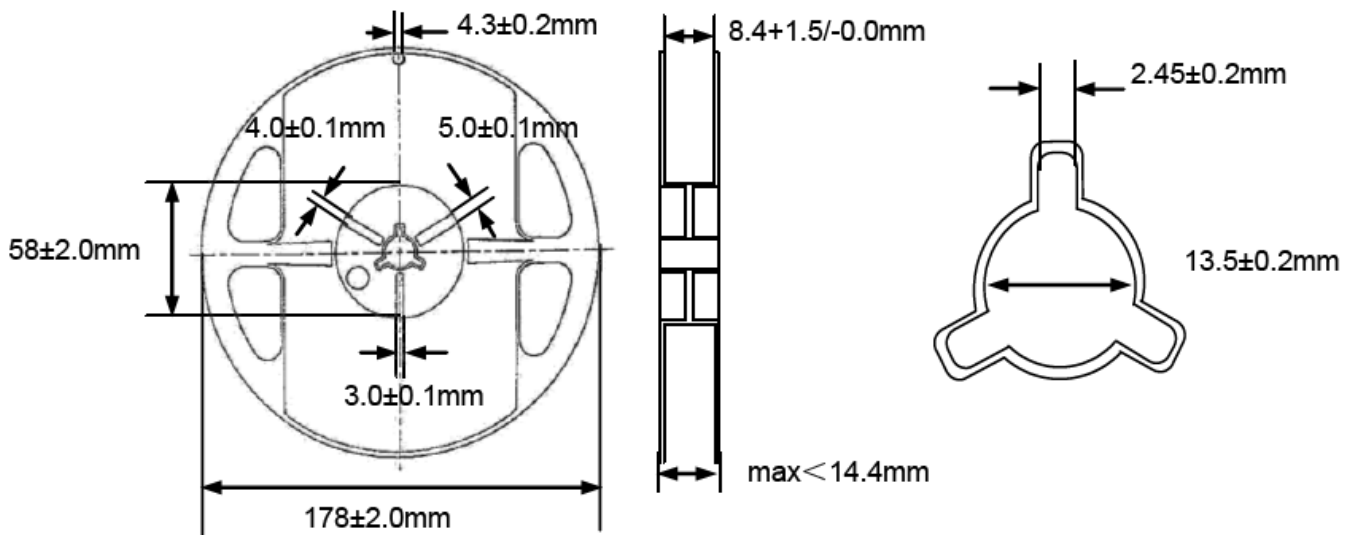
3) Reel Dimensions (Unit: mm)

X-ON Electronics

Largest Supplier of Electrical and Electronic Components

Click to view similar products for [Ferrite Beads](#) category:

Click to view products by [Sunltech](#) manufacturer:

Other Similar products are found below :

[CZB1EGTTP700P](#) [CZB1JGTTD152P](#) [CZB1JGTTD601P](#) [CZB2AFTTD800P](#) [CZB2AGTTD121P](#) [CZB2AGTTD601P](#) [CZB2BFTTE600P](#)
[PE-0402FB121ST](#) [NCB0603R301TR050F](#) [NCB0805A320TR050F](#) [NCB-H1206B680TR300F](#) [SMB2.5-1TR](#) [SMB2.5R-2](#) [CZB1EGTTP121P](#)
[CZB1JGTTD102P](#) [CZB1JGTTD121P](#) [CZB1JGTTD221P](#) [CZB1JGTTD600P](#) [CZB2AGTTD301P](#) [CZB2BFTTE301P](#) [CZB2BFTTE601P](#)
[4221R-1](#) [4221R-2](#) [432703041971](#) [EMI0805R-2000](#) [EMI0805R-600](#) [SBY100505T-100Y-N](#) [NCB-GH0402D121TR060F](#) [NCB-](#)
[H1812D125TR150F](#) [CZB2AGTTD102P](#) [NCB0402P301TR005F](#) [NCB0603R152TR030F](#) [NCB0805A121TR050F](#) [NCB3312K900TR500F](#)
[NCB-H0805A102TR150F](#) [NCB-H0805A221TR300F](#) [NCB0402P300TR030F](#) [NCB0805A102TR040F](#) [NCB1806E151TR020F](#) [NCB-](#)
[H0603R121TR300F](#) [NCB-H0805A220TR600F](#) [NCB-H0805A390TR400F](#) [NCB-H1206B601TR200F](#) [CIM21J252NE](#) [EMI0805R-220](#)
[74279250](#) [7427924](#) [CZB1JGTTD202P](#) [ABUPDE160808121Y00](#) [SA1206C101MBNT](#)