

## Multilayer Chip Ceramic Inductor



### ◆ Features

- 1、 Monolithic Structure for high reliability
- 2、 High self-resonant frequency
- 3、 Excellent solderability and high heat resistance
- 4、 RoHS Compliant.



### ◆ Application

- 1、 RF Circuit of in telecommunication and other Equipments

### ◆ PRODUCT IDENTIFICATION

**SCC 0603 C 1N0 S S P**  
**(1) (2) (3) (4) (5) (6) (7)**

- (1) Series Type
- (2) Chip Size (mm) :Length X Width
- (3) Material Code
- (4) Inductance: 1N0=1nH; 10N=10nH  
R10=100nH
- (5) Inductance Tolerance: B=±0.1; C=±0.2; S=±0.3;  
G=±2%; H=±3%; J=±5%
- (6) Company Code
- (7) Packaging:P–Embossed paper tape, 7" reel  
E- Embossed plastic tape, 7" reel

### ◆ Dimensions Unit: mm

| Size(EIA) | L         | W         | T         | E         |
|-----------|-----------|-----------|-----------|-----------|
|           | 0.60±0.05 | 0.30±0.05 | 0.30±0.05 | 0.20±0.10 |

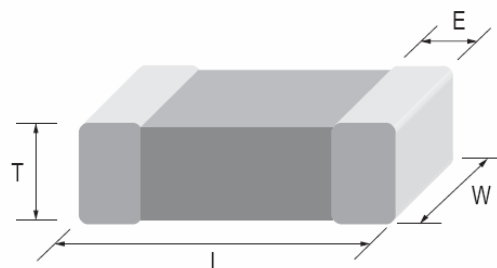

## ◆ Specifications

| Part Number           | Inductance (nH) | Min. Quality Factor (Q) | L, Q Test Freq. L/Q(MHz) | Typical Q @ Freq. (GHz) |     |     |     |     | Min. Self-resonant Frequency (MHz) | Max. DC Resistance (Ω) | Max. Rated Current (mA) |
|-----------------------|-----------------|-------------------------|--------------------------|-------------------------|-----|-----|-----|-----|------------------------------------|------------------------|-------------------------|
|                       |                 |                         |                          | 0.5                     | 0.8 | 1.8 | 2.0 | 2.4 |                                    |                        |                         |
|                       |                 |                         |                          | Q                       |     |     |     |     |                                    |                        |                         |
| <b>SCC0603 Series</b> |                 |                         |                          |                         |     |     |     |     |                                    |                        |                         |
| SCC0603C0N6◇SP        | 0.6             | 13                      | 500                      | >24                     | >32 | >54 | >57 | >65 | 10000                              | 0.06                   | 600                     |
| SCC0603C0N7◇SP        | 0.7             | 13                      | 500                      | >24                     | >32 | >54 | >57 | >65 | 10000                              | 0.06                   | 550                     |
| SCC0603C0N8◇SP        | 0.8             | 13                      | 500                      | >24                     | >32 | >54 | >57 | >65 | 10000                              | 0.07                   | 550                     |
| SCC0603C0N9◇SP        | 0.9             | 13                      | 500                      | >24                     | >32 | >54 | >57 | >65 | 10000                              | 0.07                   | 550                     |
| SCC0603C1N0◇SP        | 1.0             | 13                      | 500                      | 24                      | 32  | 54  | 57  | 65  | 10000                              | 0.08                   | 520                     |
| SCC0603C1N1◇SP        | 1.1             | 13                      | 500                      | 19                      | 26  | 45  | 47  | 55  | 10000                              | 0.11                   | 440                     |
| SCC0603C1N2◇SP        | 1.2             | 13                      | 500                      | 19                      | 25  | 43  | 44  | 52  | 10000                              | 0.12                   | 420                     |
| SCC0603C1N3◇SP        | 1.3             | 13                      | 500                      | 19                      | 25  | 40  | 42  | 47  | 10000                              | 0.12                   | 420                     |
| SCC0603C1N4◇SP        | 1.4             | 13                      | 500                      | 19                      | 24  | 39  | 41  | 47  | 10000                              | 0.11                   | 440                     |
| SCC0603C1N5◇SP        | 1.5             | 13                      | 500                      | 19                      | 24  | 39  | 41  | 46  | 10000                              | 0.12                   | 420                     |
| SCC0603C1N6◇SP        | 1.6             | 13                      | 500                      | 19                      | 24  | 39  | 41  | 46  | 10000                              | 0.13                   | 410                     |
| SCC0603C1N7◇SP        | 1.7             | 13                      | 500                      | 19                      | 24  | 39  | 41  | 46  | 10000                              | 0.15                   | 380                     |
| SCC0603C1N8◇SP        | 1.8             | 13                      | 500                      | 19                      | 24  | 39  | 41  | 46  | 10000                              | 0.15                   | 380                     |
| SCC0603C1N9◇SP        | 1.9             | 13                      | 500                      | 18                      | 24  | 38  | 40  | 45  | 10000                              | 0.18                   | 350                     |
| SCC0603C2N0◇SP        | 2.0             | 13                      | 500                      | 17                      | 24  | 38  | 39  | 44  | 10000                              | 0.23                   | 300                     |
| SCC0603C2N1◇SP        | 2.1             | 13                      | 500                      | 17                      | 24  | 37  | 39  | 44  | 10000                              | 0.24                   | 300                     |
| SCC0603C2N2◇SP        | 2.2             | 13                      | 500                      | 17                      | 24  | 38  | 40  | 43  | 10000                              | 0.25                   | 290                     |
| SCC0603C2N3◇SP        | 2.3             | 13                      | 500                      | 17                      | 24  | 37  | 39  | 43  | 10000                              | 0.20                   | 330                     |
| SCC0603C2N4◇SP        | 2.4             | 13                      | 500                      | 17                      | 23  | 36  | 38  | 42  | 10000                              | 0.22                   | 310                     |
| SCC0603C2N5◇SP        | 2.5             | 13                      | 500                      | 17                      | 23  | 35  | 36  | 40  | 9600                               | 0.20                   | 330                     |
| SCC0603C2N6◇SP        | 2.6             | 13                      | 500                      | 17                      | 22  | 34  | 35  | 39  | 9400                               | 0.20                   | 330                     |
| SCC0603C2N7◇SP        | 2.7             | 13                      | 500                      | 17                      | 22  | 34  | 35  | 39  | 9200                               | 0.22                   | 310                     |
| SCC0603C2N8◇SP        | 2.8             | 13                      | 500                      | 17                      | 22  | 34  | 35  | 39  | 8900                               | 0.24                   | 300                     |
| SCC0603C2N9◇SP        | 2.9             | 13                      | 500                      | 17                      | 22  | 34  | 35  | 39  | 8800                               | 0.26                   | 280                     |

## ◆ Specifications

| Part Number           | Inductance (nH) | Min. Quality Factor (Q) | L, Q Test Freq. L/Q(MHz) | Typical Q @ Freq. (GHz) |     |     |     |     | Min. Self-resonant Frequency (MHz) | Max. DC Resistance (Ω) | Max. Rated Current (mA) |
|-----------------------|-----------------|-------------------------|--------------------------|-------------------------|-----|-----|-----|-----|------------------------------------|------------------------|-------------------------|
|                       |                 |                         |                          | 0.5                     | 0.8 | 1.8 | 2.0 | 2.4 |                                    |                        |                         |
|                       |                 |                         |                          | Q                       |     |     |     |     |                                    |                        |                         |
| <b>SCC0603 Series</b> |                 |                         |                          |                         |     |     |     |     |                                    |                        |                         |
| SCC0603C2N9◇SP        | 2.9             | 13                      | 500                      | 17                      | 22  | 34  | 35  | 39  | 8800                               | 0.26                   | 280                     |
| SCC0603C3N0◇SP        | 3.0             | 13                      | 500                      | 17                      | 22  | 34  | 35  | 39  | 8600                               | 0.26                   | 280                     |
| SCC0603C3N1◇SP        | 3.1             | 13                      | 500                      | 17                      | 22  | 34  | 35  | 39  | 8500                               | 0.28                   | 270                     |
| SCC0603C3N2◇SP        | 3.2             | 13                      | 500                      | 17                      | 22  | 33  | 35  | 39  | 8200                               | 0.28                   | 270                     |
| SCC0603C3N3◇SP        | 3.3             | 13                      | 500                      | 18                      | 23  | 34  | 36  | 40  | 8100                               | 0.30                   | 270                     |
| SCC0603C3N4◇SP        | 3.4             | 13                      | 500                      | 17                      | 23  | 33  | 35  | 39  | 8000                               | 0.30                   | 270                     |
| SCC0603C3N5◇SP        | 3.5             | 13                      | 500                      | 17                      | 23  | 33  | 35  | 39  | 7900                               | 0.34                   | 250                     |
| SCC0603C3N6◇SP        | 3.6             | 13                      | 500                      | 16                      | 23  | 33  | 35  | 39  | 7700                               | 0.38                   | 240                     |
| SCC0603C3N7◇SP        | 3.7             | 13                      | 500                      | 16                      | 23  | 33  | 35  | 38  | 7600                               | 0.40                   | 230                     |
| SCC0603C3N8◇SP        | 3.8             | 13                      | 500                      | 16                      | 22  | 33  | 35  | 38  | 7500                               | 0.42                   | 230                     |
| SCC0603C3N9◇SP        | 3.9             | 13                      | 500                      | 16                      | 22  | 33  | 35  | 38  | 7400                               | 0.42                   | 230                     |
| SCC0603C4N3◇SP        | 4.3             | 13                      | 500                      | 16                      | 21  | 32  | 34  | 37  | 6800                               | 0.44                   | 220                     |
| SCC0603C4N7◇SP        | 4.7             | 13                      | 500                      | 16                      | 22  | 33  | 35  | 38  | 6200                               | 0.45                   | 220                     |
| SCC0603C5N1◇SP        | 5.1             | 13                      | 500                      | 17                      | 22  | 34  | 36  | 38  | 5900                               | 0.46                   | 210                     |
| SCC0603C5N6◇SP        | 5.6             | 13                      | 500                      | 16                      | 21  | 33  | 34  | 37  | 5500                               | 0.46                   | 210                     |
| SCC0603C6N2◇SP        | 6.2             | 13                      | 500                      | 18                      | 23  | 34  | 35  | 37  | 5100                               | 0.48                   | 210                     |
| SCC0603C6N8◇SP        | 6.8             | 13                      | 500                      | 17                      | 22  | 32  | 33  | 35  | 4900                               | 0.50                   | 200                     |
| SCC0603C7N5◇SP        | 7.5             | 13                      | 500                      | 16                      | 21  | 31  | 33  | 34  | 4700                               | 0.50                   | 200                     |
| SCC0603C8N2◇SP        | 8.2             | 13                      | 500                      | 16                      | 21  | 31  | 32  | 34  | 4300                               | 0.56                   | 190                     |
| SCC0603C9N1◇SP        | 9.1             | 13                      | 500                      | 16                      | 20  | 30  | 31  | 32  | 4100                               | 0.72                   | 170                     |
| SCC0603C10N◇SP        | 10              | 13                      | 500                      | 16                      | 20  | 28  | 29  | 31  | 3800                               | 0.80                   | 160                     |
| SCC0603C12N◇SP        | 12              | 13                      | 500                      | 16                      | 20  | 27  | 28  | 28  | 3400                               | 0.80                   | 160                     |
| SCC0603C15N◇SP        | 15              | 13                      | 500                      | 15                      | 19  | 24  | 24  | 23  | 2600                               | 0.85                   | 160                     |
| SCC0603C18N◇SP        | 18              | 13                      | 500                      | 15                      | 19  | 23  | 24  | 22  | 2300                               | 1.00                   | 140                     |

## ◆ Specifications

| Part Number           | Inductance (nH) | Min. Quality Factor (Q) | L, Q Test Freq. L/Q(MHz) | Typical Q @ Freq. (GHz) |     |     |     |     | Min. Self-resonant Frequency (MHz) | Max. DC Resistance (Ω) | Max. Rated Current (mA) |
|-----------------------|-----------------|-------------------------|--------------------------|-------------------------|-----|-----|-----|-----|------------------------------------|------------------------|-------------------------|
|                       |                 |                         |                          | 0.5                     | 0.8 | 1.8 | 2.0 | 2.4 |                                    |                        |                         |
|                       |                 |                         |                          | Q                       |     |     |     |     |                                    |                        |                         |
| <b>SCC0603 Series</b> |                 |                         |                          |                         |     |     |     |     |                                    |                        |                         |
| SCC0603C22N◇SP        | 22              | 13                      | 500                      | 15                      | 19  | 22  | 23  | 20  | 1900                               | 1.20                   | 130                     |
| SCC0603C27N◇SP        | 27              | 13                      | 500                      | 15                      | 19  | 15  | 13  | 8   | 1800                               | 1.60                   | 120                     |
| SCC0603C33N◇SP        | 33              | 11                      | 300                      | 14                      | 15  | 8   | 5   | -   | 1800                               | 2.20                   | 110                     |
| SCC0603C39N◇SP        | 39              | 11                      | 300                      | 14                      | 15  | 6   | -   | -   | 1600                               | 2.30                   | 100                     |
| SCC0603C47N◇SP        | 47              | 11                      | 300                      | 14                      | 15  | -   | -   | -   | 1500                               | 2.60                   | 100                     |
| SCC0603C56N◇SP        | 56              | 11                      | 300                      | 13                      | 13  | -   | -   | -   | 1400                               | 2.80                   | 80                      |
| SCC0603C68N◇SP        | 68              | 11                      | 300                      | 13                      | 11  | -   | -   | -   | 1200                               | 3.20                   | 80                      |
| SCC0603C82N◇SP        | 82              | 10                      | 300                      | 12                      | 10  | -   | -   | -   | 1100                               | 3.80                   | 70                      |
| SCC0603CR10◇SP        | 100             | 10                      | 300                      | 12                      | 10  | -   | -   | -   | 1000                               | 4.00                   | 60                      |
| SCC0603CR12◇SP        | 120             | 9                       | 300                      | 12                      | 8   | -   | -   | -   | 1000                               | 5.00                   | 50                      |

Note: ◇: Please specify the inductance tolerance. For  $L \leq 6.2\text{nH}$ , choose  $B = \pm 0.1\text{nH}$ ,  $C = \pm 0.2\text{nH}$  or  $S = \pm 0.3\text{nH}$ ; For  $L > 6.2\text{nH}$ , choose  $G = \pm 2\%$ ,  $H = \pm 3\%$  or  $J = 5\%$ .

## ◆ General Technical Data

|                                    |                           |
|------------------------------------|---------------------------|
| <b>Operating Temperature Range</b> | -55°C ~ +125°C            |
| <b>Storage Condition</b>           | Less than 40°C and 70% RH |
| <b>Soldering Method</b>            | Reflow or Wave Soldering  |

## ◆ Composition / Information on Ingredients

Product Structure: See Fig.1, Fig. 2 and Fig. 3



**Fig.1 Shape**

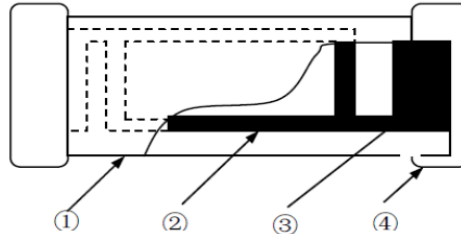

**Fig.2 Body Structure**

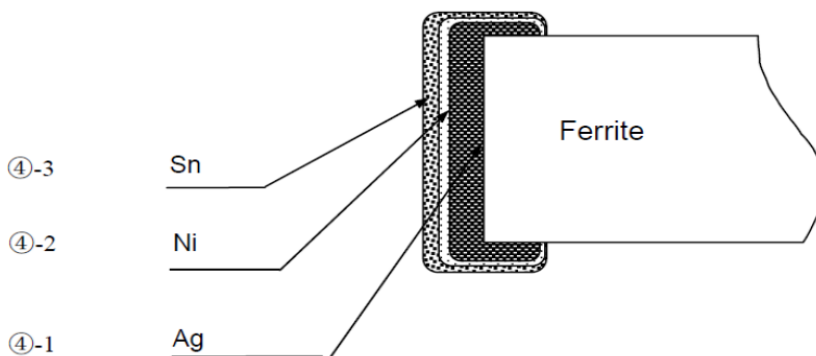

**Fig. 3 Structure of Electro-plating**

| Composition/Information on the Components |                                   |                                                         |
|-------------------------------------------|-----------------------------------|---------------------------------------------------------|
| Code                                      | Material                          | Main Components                                         |
| ①                                         | Ceramic                           | Boron Silicate, Al <sub>2</sub> O <sub>3</sub> , Secret |
| ②                                         | Inner Coil                        | Silver (Ag)                                             |
| ③                                         | Pull-out Electrode                | Silver (Ag)                                             |
| ④-1                                       | Terminal Electrode                | Silver (Ag)                                             |
| ④-2                                       | Electrode-plating: Nickel plating | Nickel (Ni)                                             |
| ④-3                                       | Electrode-plating: Sn plating     | Tin (Sn)                                                |

  

| Compositions Wt Rate (Wt%) of Material |               |            |
|----------------------------------------|---------------|------------|
| Material                               | Wt Rate (Wt%) | CAS No.    |
| Boron Silicate                         | 51~65         | 65997-18-4 |
| Al <sub>2</sub> O <sub>3</sub>         | 14~17         | 1344-28-1  |
| Secret                                 | 0~5           | -          |
| Ag                                     | 9~29          | 7440-22-4  |
| Nickel                                 | 1.8~2.3       | 7440-02-0  |
| Tin                                    | 3.6~4.7       | 7440-31-5  |
|                                        |               |            |
|                                        |               |            |
|                                        |               |            |

◆ TYPICAL ELECTRICAL CHARACTERISTICS

SCC0603 Series

Inductance vs. Frequency Characteristics

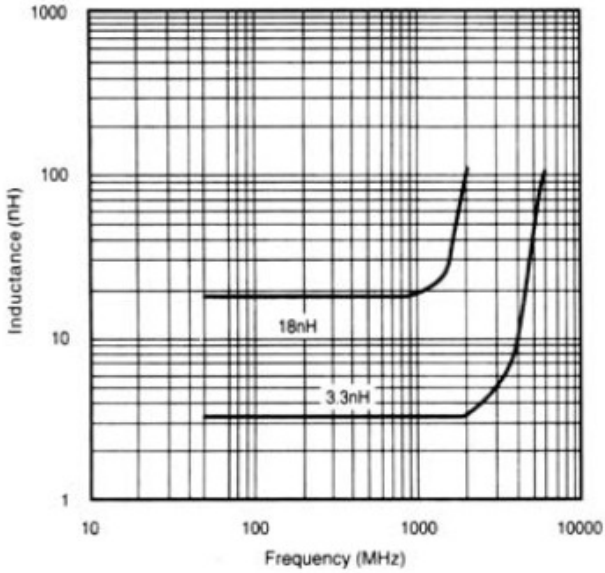

Impedance vs. Frequency Characteristics

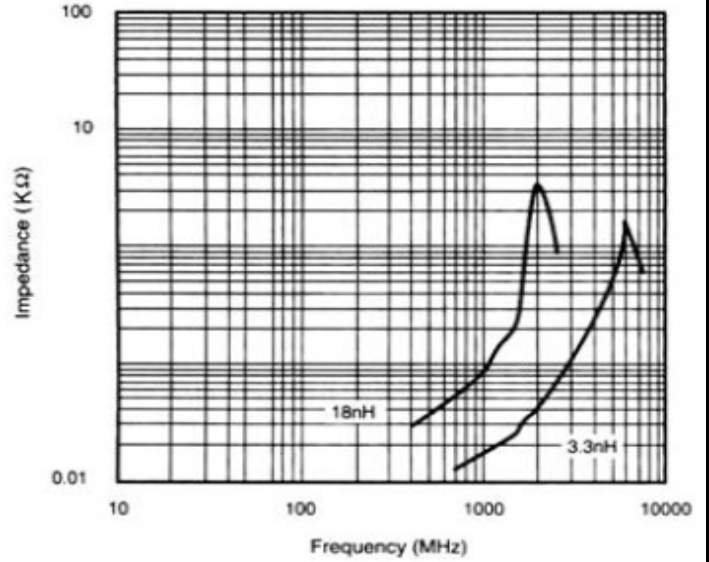

Q vs. Frequency Characteristics

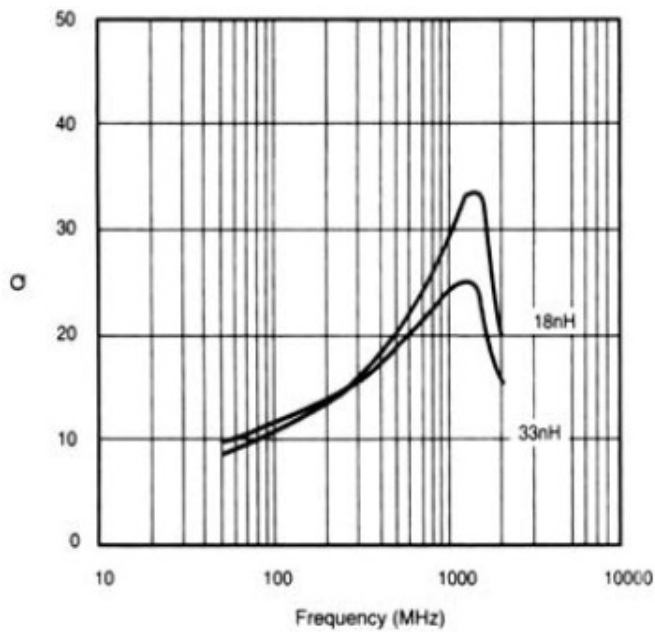

## ◆ Packaging

(1) Taping Drawings (Unit: mm)

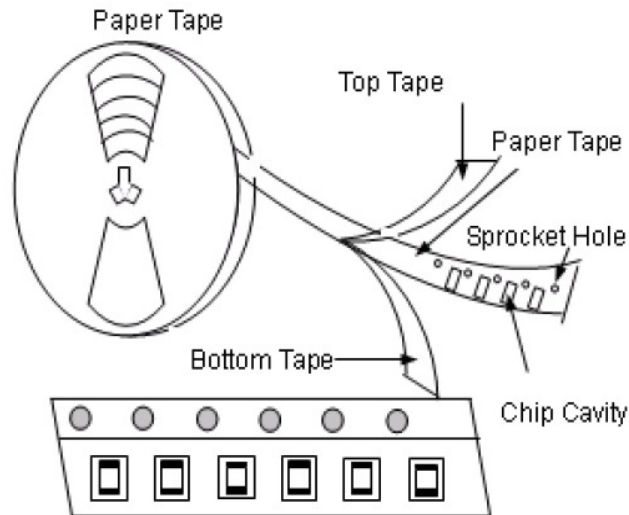

**Remark:** The sprocket holes are to the right as the tape is pulled toward the user.

(2) Taping Dimensions (Unit: mm)

Sprocket Hole  $\Phi 1.5 (+0.1, 0)$

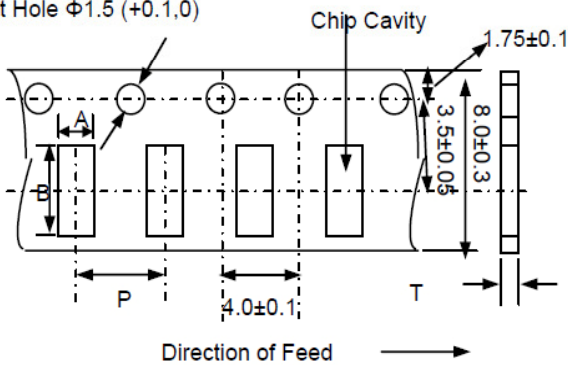

Paper Tape

| Type       | A             | B             | P              | T max | Quantity |
|------------|---------------|---------------|----------------|-------|----------|
| 0603(0201) | $0.4 \pm 0.1$ | $0.7 \pm 0.1$ | $2.0 \pm 0.05$ | 0.55  | 15K      |

(3) Reel Dimensions (Unit: mm)

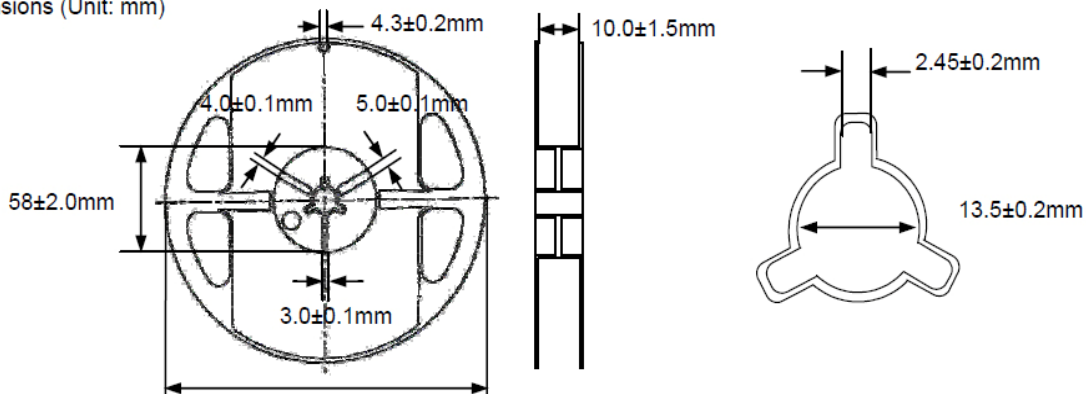

## X-ON Electronics

Largest Supplier of Electrical and Electronic Components

*Click to view similar products for [Fixed Inductors](#) category:*

*Click to view products by [Sunltech](#) manufacturer:*

Other Similar products are found below :

[MLZ1608M6R8WTD25](#) [MLZ1608N6R8LT000](#) [MLZ1608N3R3LTD25](#) [MLZ1608N3R3LT000](#) [MLZ1608N150LT000](#)

[MLZ1608M150WTD25](#) [MLZ1608M3R3WTD25](#) [MLZ1608M3R3WT000](#) [MLZ1608M150WT000](#) [MLZ1608A1R5WT000](#)

[MLZ1608N1R5LT000](#) [B82432C1333K000](#) [PCMB053T-1R0MS](#) [PCMB053T-1R5MS](#) [PCMB104T-1R5MS](#) [CR32NP-100KC](#) [CR32NP-](#)

[151KC](#) [CR32NP-180KC](#) [CR32NP-181KC](#) [CR32NP-1R5MC](#) [CR32NP-390KC](#) [CR32NP-3R9MC](#) [CR32NP-680KC](#) [CR32NP-820KC](#)

[CR32NP-8R2MC](#) [CR43NP-390KC](#) [CR43NP-560KC](#) [CR43NP-680KC](#) [CR54NP-181KC](#) [CR54NP-470LC](#) [CR54NP-820KC](#) [CR54NP-8R5MC](#)

[MGDQ4-00004-P](#) [MGDU1-00016-P](#) [MHL1ECTTP18NJ](#) [MHL1JCTTD12NJ](#) [PE-51506NL](#) [PE-53601NL](#) [PE-53630NL](#) [PE-53824SNLT](#) [PE-](#)

[62892NL](#) [PE-92100NL](#) [PG0434.801NLT](#) [PG0936.113NLT](#) [PM06-2N7](#) [PM06-39NJ](#) [HC2LP-R47-R](#) [HC2-R47-R](#) [HC3-2R2-R](#) [HC8-1R2-R](#)