

## Multilayer Chip Ceramic Inductor

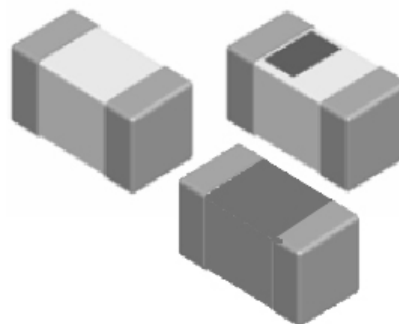

### ◆ Features

- 1、 Monolithic Structure for high reliability
- 2、 High self-resonant frequency
- 3、 Excellent solderability and high heat resistance
- 4、 RoHS Compliant.



### ◆ Application

- 1、 RF Circuit of in telecommunication and other Equipments

### ◆ PRODUCT IDENTIFICATION

**SCC 1005 C 1N0 S S P**  
**(1) (2) (3) (4) (5) (6) (7)**

- (1) Series Type
- (2) Chip Size (mm) :Length X Width
- (3) Material Code
- (4) Inductance: 1N0=1nH; 10N=10nH  
R10=100nH
- (5) Inductance Tolerance: S=±0.3;  
J=±5%; K=±10%
- (6) Company Code
- (7) Packaging:P–Embossed paper tape, 7" reel  
E- Embossed plastic tape, 7" reel

### ◆ Dimensions Unit: mm

| Size(EIA) | L         | W         | T         | E         |
|-----------|-----------|-----------|-----------|-----------|
|           | 1.00±0.10 | 0.50±0.10 | 0.50±0.10 | 0.25±0.10 |

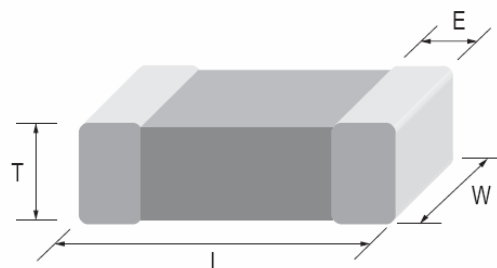

## ◆ Specifications

| Part Number           | Inductance (nH) | Min. Quality Factor (Q) | L, Q Test Freq. L/Q(MHz) | Typical Q @ Freq. (MHz) |     |     |     |      |      | Min. Self-resonant Frequency (MHz) | Max. DC Resistance (Ω) | Max. Rated Current (mA) |
|-----------------------|-----------------|-------------------------|--------------------------|-------------------------|-----|-----|-----|------|------|------------------------------------|------------------------|-------------------------|
|                       |                 |                         |                          | 100                     | 300 | 500 | 800 | 1000 | 1800 |                                    |                        |                         |
|                       |                 |                         |                          | Q                       |     |     |     |      |      |                                    |                        |                         |
| <b>SCC1005 Series</b> |                 |                         |                          |                         |     |     |     |      |      |                                    |                        |                         |
| SCC1005C1N0SSP        | 1.0±0.3         | 8                       | 100                      | 11                      | 21  | 25  | 33  | 35   | 52   | 6000                               | 0.1                    | 400                     |
| SCC1005C1N1SSP        | 1.1±0.3         | 8                       | 100                      | 11                      | 21  | 25  | 33  | 35   | 52   | 6000                               | 0.1                    | 400                     |
| SCC1005C1N2SSP        | 1.2±0.3         | 8                       | 100                      | 11                      | 21  | 25  | 33  | 35   | 52   | 6000                               | 0.1                    | 400                     |
| SCC1005C1N3SSP        | 1.3±0.3         | 8                       | 100                      | 11                      | 21  | 25  | 33  | 35   | 52   | 6000                               | 0.12                   | 400                     |
| SCC1005C1N5SSP        | 1.5±0.3         | 8                       | 100                      | 11                      | 21  | 25  | 33  | 35   | 52   | 6000                               | 0.13                   | 400                     |
| SCC1005C1N8SSP        | 1.8±0.3         | 8                       | 100                      | 10                      | 18  | 21  | 29  | 32   | 49   | 6000                               | 0.14                   | 400                     |
| SCC1005C2N0SSP        | 2.0±0.3         | 8                       | 100                      | 10                      | 17  | 21  | 28  | 32   | 47   | 6000                               | 0.15                   | 400                     |
| SCC1005C2N2SSP        | 2.2±0.3         | 8                       | 100                      | 10                      | 17  | 21  | 28  | 31   | 47   | 6000                               | 0.16                   | 400                     |
| SCC1005C2N4SSP        | 2.4±0.3         | 8                       | 100                      | 10                      | 17  | 21  | 28  | 31   | 46   | 5500                               | 0.16                   | 400                     |
| SCC1005C2N7SSP        | 2.7±0.3         | 8                       | 100                      | 10                      | 17  | 21  | 28  | 31   | 46   | 5500                               | 0.17                   | 400                     |
| SCC1005C3N0SSP        | 3.0±0.3         | 8                       | 100                      | 10                      | 17  | 21  | 28  | 31   | 46   | 5500                               | 0.18                   | 400                     |
| SCC1005C3N3SSP        | 3.3±0.3         | 8                       | 100                      | 10                      | 17  | 21  | 28  | 31   | 46   | 5500                               | 0.19                   | 400                     |
| SCC1005C3N6SSP        | 3.6±0.3         | 8                       | 100                      | 10                      | 17  | 21  | 28  | 31   | 45   | 5200                               | 0.22                   | 400                     |
| SCC1005C3N9SSP        | 3.9±0.3         | 8                       | 100                      | 10                      | 17  | 21  | 28  | 31   | 45   | 5200                               | 0.22                   | 400                     |
| SCC1005C4N3SSP        | 4.3±0.3         | 8                       | 100                      | 10                      | 17  | 21  | 28  | 31   | 45   | 4800                               | 0.24                   | 400                     |
| SCC1005C4N7SSP        | 4.7±0.3         | 8                       | 100                      | 10                      | 17  | 21  | 28  | 31   | 45   | 4800                               | 0.24                   | 400                     |
| SCC1005C5N1SSP        | 5.1±0.3         | 8                       | 100                      | 10                      | 17  | 21  | 25  | 29   | 44   | 4600                               | 0.26                   | 400                     |
| SCC1005C5N6SSP        | 5.6±0.3         | 8                       | 100                      | 10                      | 17  | 21  | 25  | 29   | 44   | 4600                               | 0.27                   | 400                     |
| SCC1005C6N2SSP        | 6.2±0.3         | 8                       | 100                      | 10                      | 17  | 21  | 25  | 29   | 44   | 4200                               | 0.3                    | 300                     |
| SCC1005C6N8JSP        | 6.8             | 8                       | 100                      | 10                      | 18  | 21  | 26  | 30   | 44   | 4000                               | 0.32                   | 300                     |
| SCC1005C7N5JSP        | 7.5             | 8                       | 100                      | 10                      | 18  | 21  | 26  | 30   | 43   | 3600                               | 0.37                   | 300                     |
| SCC1005C8N2JSP        | 8.2             | 8                       | 100                      | 10                      | 18  | 21  | 26  | 30   | 43   | 3600                               | 0.37                   | 300                     |
| SCC1005C9N1JSP        | 9.1             | 8                       | 100                      | 10                      | 18  | 21  | 26  | 30   | 42   | 3200                               | 0.42                   | 300                     |
| SCC1005C10NJSP        | 10              | 8                       | 100                      | 10                      | 18  | 21  | 26  | 30   | 42   | 3200                               | 0.42                   | 300                     |
| SCC1005C12NJSP        | 12              | 8                       | 100                      | 10                      | 17  | 21  | 24  | 27   | 33   | 2800                               | 0.5                    | 300                     |
| SCC1005C15NJSP        | 15              | 8                       | 100                      | 10                      | 17  | 20  | 23  | 26   | 27   | 2500                               | 0.55                   | 300                     |

## ◆ Specifications

| Part Number           | Inductance (nH) | Min. Quality Factor (Q) | L, Q Test Freq. L/Q(MHz) | Typical Q @ Freq. (MHz) |     |     |     |      |      | Min. Self-resonant Frequency (MHz) | Max. DC Resistance (Ω) | Max. Rated Current (mA) |
|-----------------------|-----------------|-------------------------|--------------------------|-------------------------|-----|-----|-----|------|------|------------------------------------|------------------------|-------------------------|
|                       |                 |                         |                          | 100                     | 300 | 500 | 800 | 1000 | 1800 |                                    |                        |                         |
|                       |                 |                         |                          | Q                       |     |     |     |      |      |                                    |                        |                         |
| <b>SCC1005 Series</b> |                 |                         |                          |                         |     |     |     |      |      |                                    |                        |                         |
| SCC1005C18NJSP        | 18              | 8                       | 100                      | 10                      | 17  | 20  | 21  | 23   | 9    | 2200                               | 0.65                   | 300                     |
| SCC1005C22NJSP        | 22              | 8                       | 100                      | 10                      | 18  | 21  | 22  | 23   | -    | 2000                               | 0.8                    | 200                     |
| SCC1005C27NJSP        | 27              | 8                       | 100                      | 10                      | 18  | 20  | 21  | 22   | -    | 1600                               | 0.9                    | 200                     |
| SCC1005C33NJSP        | 33              | 8                       | 100                      | 10                      | 18  | 20  | 21  | 21   | -    | 1300                               | 1                      | 200                     |
| SCC1005C39NJSP        | 39              | 8                       | 100                      | 10                      | 18  | 19  | 20  | 17   | -    | 1200                               | 1.2                    | 150                     |
| SCC1005C47NJSP        | 47              | 8                       | 100                      | 10                      | 18  | 19  | 18  | -    | -    | 1000                               | 1.3                    | 150                     |
| SCC1005C56NJSP        | 56              | 8                       | 100                      | 10                      | 18  | 19  | 13  | -    | -    | 900                                | 1.6                    | 150                     |
| SCC1005C68NJSP        | 68              | 8                       | 100                      | 10                      | 18  | 19  | 13  | -    | -    | 800                                | 2.1                    | 150                     |
| SCC1005C82NJSP        | 82              | 8                       | 100                      | 10                      | 18  | 19  | 13  | -    | -    | 750                                | 2.4                    | 150                     |
| SCC1005CR10JSP        | 100             | 8                       | 100                      | 10                      | 18  | 19  | 12  | -    | -    | 700                                | 2.6                    | 150                     |
| SCC1005CR12JSP        | 120             | 8                       | 100                      | 10                      | 18  | 19  | -   | -    | -    | 600                                | 2.8                    | 150                     |
| SCC1005CR15JSP        | 150             | 8                       | 100                      | 10                      | 17  | 8   | -   | -    | -    | 550                                | 3.2                    | 100                     |
| SCC1005CR18JSP        | 180             | 8                       | 100                      | 10                      | 17  | -   | -   | -    | -    | 500                                | 3.7                    | 100                     |
| SCC1005CR22JSP        | 220             | 8                       | 100                      | 12                      | 14  | -   | -   | -    | -    | 450                                | 4.0                    | 100                     |
| SCC1005CR27JSP        | 270             | 8                       | 100                      | 12                      | 12  | -   | -   | -    | -    | 400                                | 4.5                    | 100                     |
| SCC1005CR30JSP        | 300             | 5                       | 50                       | 12                      | -   | -   | -   | -    | -    | 350                                | 7.0                    | 50                      |
| SCC1005CR33JSP        | 330             | 5                       | 50                       | 8                       | -   | -   | -   | -    | -    | 350                                | 7.0                    | 50                      |
| SCC1005CR36JSP        | 360             | 5                       | 50                       | 12                      | -   | -   | -   | -    | -    | 300                                | 7.5                    | 50                      |

## ◆ General Technical Data

|                                    |                           |
|------------------------------------|---------------------------|
| <b>Operating Temperature Range</b> | -55°C ~ +125°C            |
| <b>Storage Condition</b>           | Less than 40°C and 70% RH |
| <b>Soldering Method</b>            | Reflow or Wave Soldering  |

◆ **Composition / Information on Ingredients**

Product Structure: See Fig.1, Fig. 2 and Fig. 3



**Fig.1 Shape**

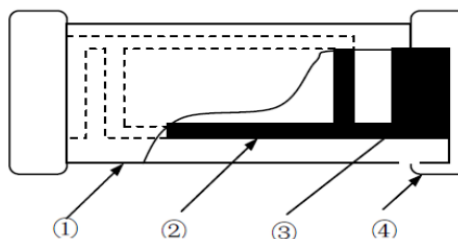

**Fig.2 Body Structure**

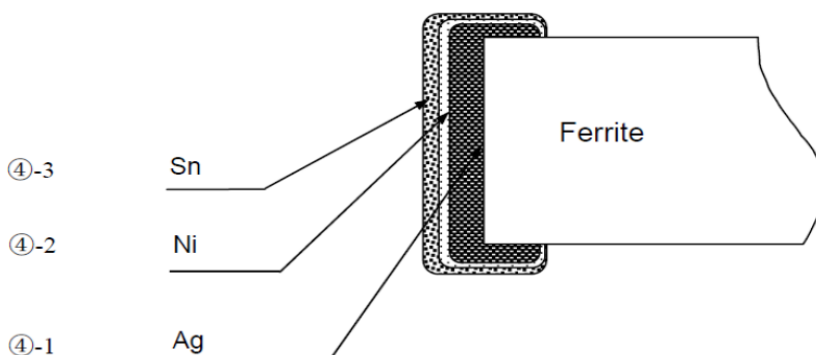

**Fig. 3 Structure of Electro-plating**

| Composition/Information on the Components |                                   |   |
|---|-----------------------------------|---|
| Code                                      | Material                          | Main Components   |
| ①   | Ceramic                           | Boron Silicate, Al <sub>2</sub> O <sub>3</sub> , Secret |
| ②   | Inner Coil                        | Silver (Ag)   |
| ③   | Pull-out Electrode                | Silver (Ag)   |
| ④-1                                       | Terminal Electrode                | Silver (Ag)   |
| ④-2                                       | Electrode-plating: Nickel plating | Nickel (Ni)   |
| ④-3                                       | Electrode-plating: Sn plating     | Tin (Sn)  |

  

| Compositions Wt Rate (Wt%) of Material |               |            |
|--|---------------|------------|
| Material                               | Wt Rate (Wt%) | CAS No.    |
| Boron Silicate                         | 51~65         | 65997-18-4 |
| Al <sub>2</sub> O <sub>3</sub>         | 14~17         | 1344-28-1  |
| Secret                                 | 0~5           | -          |
| Ag                                     | 9~29          | 7440-22-4  |
| Nickel                                 | 1.8~2.3       | 7440-02-0  |
| Tin                                    | 3.6~4.7       | 7440-31-5  |
|  |               |            |
|  |               |            |
|  |               |            |

◆ **TYPICAL ELECTRICAL CHARACTERISTICS**

**SCC1005 Series**

**Inductance vs. Frequency Characteristics**

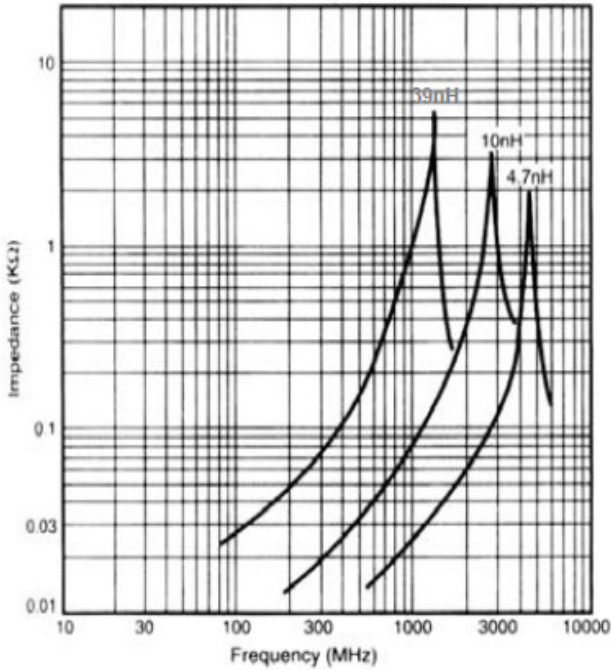

**Impedance vs. Frequency Characteristics**

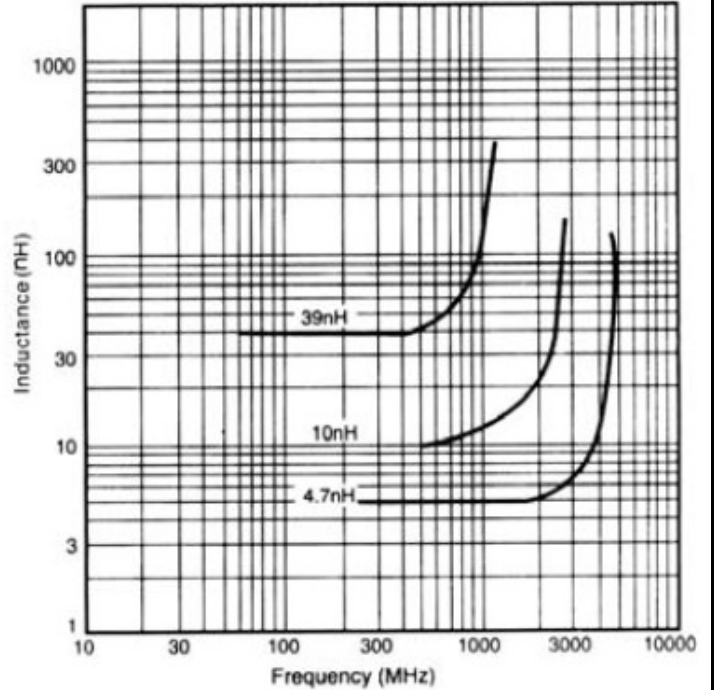

**Q vs. Frequency Characteristics**

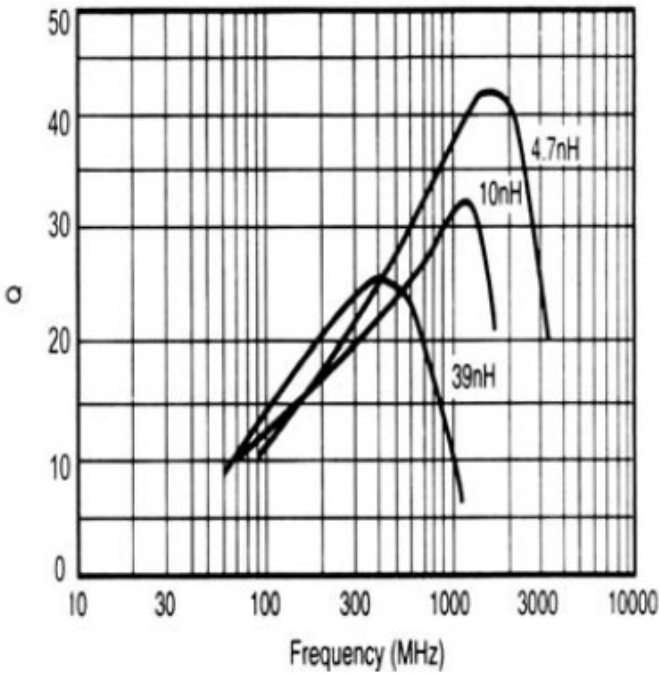

## ◆ Packaging

### (1) Taping Drawings (Unit: mm)

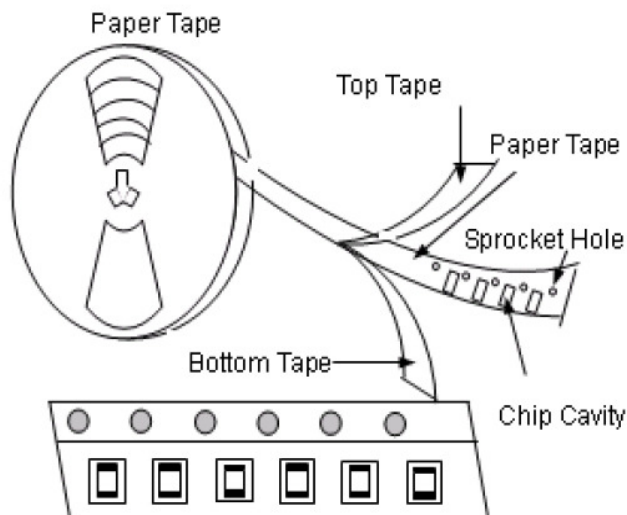

**Remark:** The sprocket holes are to the right as the tape is pulled toward the user.

### (2) Taping Dimensions (Unit: mm)

Sprocket Hole  $\Phi 1.5 (+0.1, 0)$

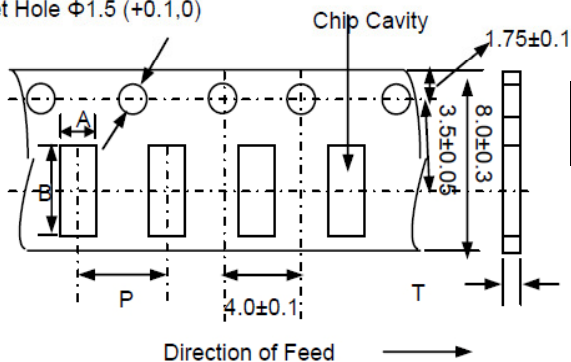

Paper Tape

| Type       | A               | B              | P              | T max | Quantity |
|------------|-----------------|----------------|----------------|-------|----------|
| 1005(0402) | $0.065 \pm 0.1$ | $1.15 \pm 0.1$ | $2.0 \pm 0.05$ | 0.8   | 10K      |

### (3) Reel Dimensions (Unit: mm)

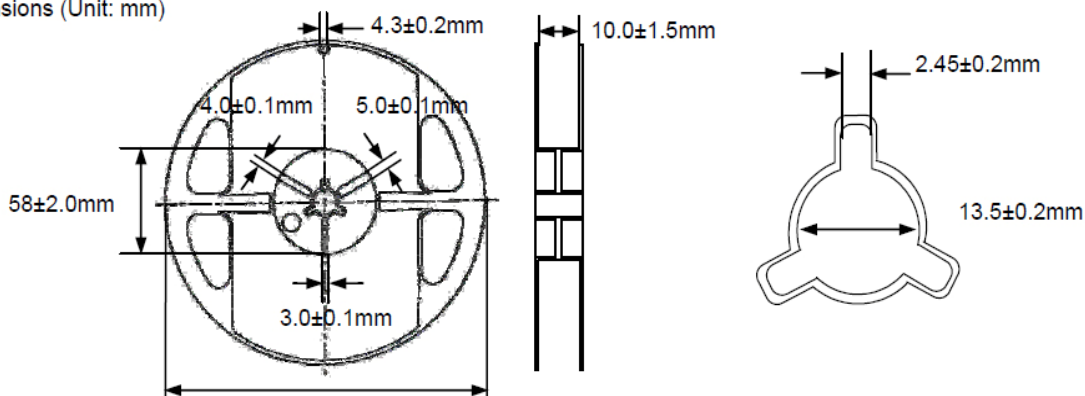

## X-ON Electronics

Largest Supplier of Electrical and Electronic Components

*Click to view similar products for [Fixed Inductors](#) category:*

*Click to view products by [Sunltech](#) manufacturer:*

Other Similar products are found below :

[CR32NP-100KC](#) [CR32NP-151KC](#) [CR32NP-180KC](#) [CR32NP-181KC](#) [CR32NP-1R5MC](#) [CR32NP-390KC](#) [CR32NP-3R9MC](#) [CR32NP-680KC](#) [CR32NP-820KC](#) [CR32NP-8R2MC](#) [CR43NP-390KC](#) [CR43NP-560KC](#) [CR43NP-680KC](#) [CR54NP-181KC](#) [CR54NP-470LC](#) [CR54NP-820KC](#) [CR54NP-8R5MC](#) [70F224AI](#) [MGDQ4-00004-P](#) [MHL1ECTTP18NJ](#) [MHQ1005P10NJ](#) [MHQ1005P1N0S](#) [MHQ1005P2N4S](#) [MHQ1005P3N6S](#) [MHQ1005P5N1S](#) [MHQ1005P8N2J](#) [PE-51506NL](#) [PE-53601NL](#) [PE-53602NL](#) [PE-53630NL](#) [PE-53824SNLT](#) [PE-92100NL](#) [PG0434.801NLT](#) [PG0936.113NLT](#) [9220-20](#) [9310-16](#) [PM06-2N7](#) [PM06-39NJ](#) [A01TK](#) [1206CS-471XJ](#) [HC2LP-R47-R](#) [HC2-R47-R](#) [HC3-2R2-R](#) [HCF1305-3R3-R](#) [1206CS-151XG](#) [RCH664NP-140L](#) [RCH664NP-4R7M](#) [RCH8011NP-221L](#) [RCP1317NP-332L](#) [RCP1317NP-391L](#)