

## Multilayer Chip Ceramic Inductor

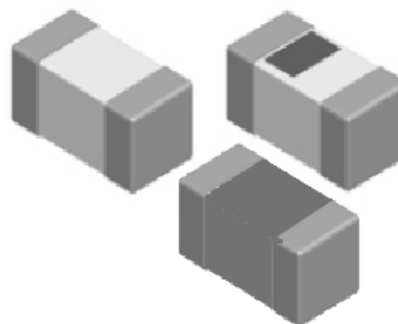

### ◆ Features

- 1、 Monolithic Structure for high reliability
- 2、 High self-resonant frequency
- 3、 Excellent solderability and high heat resistance
- 4、 RoHS Compliant.



### ◆ Application

- 1、 RF Circuit of in telecommunication and other Equipments

### ◆ PRODUCT IDENTIFICATION

**SCC 1005 C 1N0 S S P**  
**(1) (2) (3) (4) (5) (6) (7)**

- (1) Series Type
- (2) Chip Size (mm) :Length X Width
- (3) Material Code
- (4) Inductance: 1N0=1nH; 10N=10nH  
R10=100nH
- (5) Inductance Tolerance: S=±0.3;  
J=±5%; K=±10%
- (6) Company Code
- (7) Packaging:P–Embossed paper tape, 7" reel  
E- Embossed plastic tape, 7" reel

### ◆ Dimensions Unit: mm

Size(EIA)	L	W	T	E
	1.00±0.10	0.50±0.10	0.50±0.10	0.25±0.10



## ◆ Specifications

Part Number	Inductance (nH)	Min. Quality Factor (Q)	L, Q Test Freq. L/Q(MHz)	Typical Q @ Freq. (MHz)						Min. Self-resonant Frequency (MHz)	Max. DC Resistance (Ω)	Max. Rated Current (mA)
				100	300	500	800	1000	1800			
				Q								
<b>SCC1005 Series</b>												
SCC1005C1N0SSP	1.0±0.3	8	100	11	21	25	33	35	52	6000	0.1	400
SCC1005C1N1SSP	1.1±0.3	8	100	11	21	25	33	35	52	6000	0.1	400
SCC1005C1N2SSP	1.2±0.3	8	100	11	21	25	33	35	52	6000	0.1	400
SCC1005C1N3SSP	1.3±0.3	8	100	11	21	25	33	35	52	6000	0.12	400
SCC1005C1N5SSP	1.5±0.3	8	100	11	21	25	33	35	52	6000	0.13	400
SCC1005C1N8SSP	1.8±0.3	8	100	10	18	21	29	32	49	6000	0.14	400
SCC1005C2N0SSP	2.0±0.3	8	100	10	17	21	28	32	47	6000	0.15	400
SCC1005C2N2SSP	2.2±0.3	8	100	10	17	21	28	31	47	6000	0.16	400
SCC1005C2N4SSP	2.4±0.3	8	100	10	17	21	28	31	46	5500	0.16	400
SCC1005C2N7SSP	2.7±0.3	8	100	10	17	21	28	31	46	5500	0.17	400
SCC1005C3N0SSP	3.0±0.3	8	100	10	17	21	28	31	46	5500	0.18	400
SCC1005C3N3SSP	3.3±0.3	8	100	10	17	21	28	31	46	5500	0.19	400
SCC1005C3N6SSP	3.6±0.3	8	100	10	17	21	28	31	45	5200	0.22	400
SCC1005C3N9SSP	3.9±0.3	8	100	10	17	21	28	31	45	5200	0.22	400
SCC1005C4N3SSP	4.3±0.3	8	100	10	17	21	28	31	45	4800	0.24	400
SCC1005C4N7SSP	4.7±0.3	8	100	10	17	21	28	31	45	4800	0.24	400
SCC1005C5N1SSP	5.1±0.3	8	100	10	17	21	25	29	44	4600	0.26	400
SCC1005C5N6SSP	5.6±0.3	8	100	10	17	21	25	29	44	4600	0.27	400
SCC1005C6N2SSP	6.2±0.3	8	100	10	17	21	25	29	44	4200	0.3	300
SCC1005C6N8JSP	6.8	8	100	10	18	21	26	30	44	4000	0.32	300
SCC1005C7N5JSP	7.5	8	100	10	18	21	26	30	43	3600	0.37	300
SCC1005C8N2JSP	8.2	8	100	10	18	21	26	30	43	3600	0.37	300
SCC1005C9N1JSP	9.1	8	100	10	18	21	26	30	42	3200	0.42	300
SCC1005C10NJSP	10	8	100	10	18	21	26	30	42	3200	0.42	300
SCC1005C12NJSP	12	8	100	10	17	21	24	27	33	2800	0.5	300
SCC1005C15NJSP	15	8	100	10	17	20	23	26	27	2500	0.55	300

## ◆ Specifications

Part Number	Inductance (nH)	Min. Quality Factor (Q)	L, Q Test Freq. L/Q(MHz)	Typical Q @ Freq. (MHz)						Min. Self-resonant Frequency (MHz)	Max. DC Resistance (Ω)	Max. Rated Current (mA)
				100	300	500	800	1000	1800			
				Q								
<b>SCC1005 Series</b>												
SCC1005C18NJSP	18	8	100	10	17	20	21	23	9	2200	0.65	300
SCC1005C22NJSP	22	8	100	10	18	21	22	23	-	2000	0.8	200
SCC1005C27NJSP	27	8	100	10	18	20	21	22	-	1600	0.9	200
SCC1005C33NJSP	33	8	100	10	18	20	21	21	-	1300	1	200
SCC1005C39NJSP	39	8	100	10	18	19	20	17	-	1200	1.2	150
SCC1005C47NJSP	47	8	100	10	18	19	18	-	-	1000	1.3	150
SCC1005C56NJSP	56	8	100	10	18	19	13	-	-	900	1.6	150
SCC1005C68NJSP	68	8	100	10	18	19	13	-	-	800	2.1	150
SCC1005C82NJSP	82	8	100	10	18	19	13	-	-	750	2.4	150
SCC1005CR10JSP	100	8	100	10	18	19	12	-	-	700	2.6	150
SCC1005CR12JSP	120	8	100	10	18	19	-	-	-	600	2.8	150
SCC1005CR15JSP	150	8	100	10	17	8	-	-	-	550	3.2	100
SCC1005CR18JSP	180	8	100	10	17	-	-	-	-	500	3.7	100
SCC1005CR22JSP	220	8	100	12	14	-	-	-	-	450	4.0	100
SCC1005CR27JSP	270	8	100	12	12	-	-	-	-	400	4.5	100
SCC1005CR30JSP	300	5	50	12	-	-	-	-	-	350	7.0	50
SCC1005CR33JSP	330	5	50	8	-	-	-	-	-	350	7.0	50
SCC1005CR36JSP	360	5	50	12	-	-	-	-	-	300	7.5	50

## ◆ General Technical Data

<b>Operating Temperature Range</b>	-55°C ~ +125°C
<b>Storage Condition</b>	Less than 40°C and 70% RH
<b>Soldering Method</b>	Reflow or Wave Soldering

◆ **Composition / Information on Ingredients**

Product Structure: See Fig.1, Fig. 2 and Fig. 3



**Fig.1 Shape**

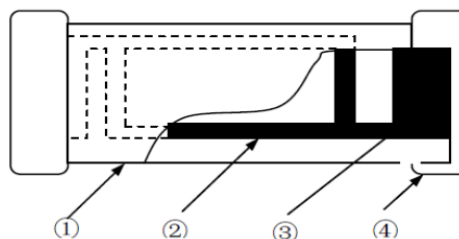

**Fig.2 Body Structure**

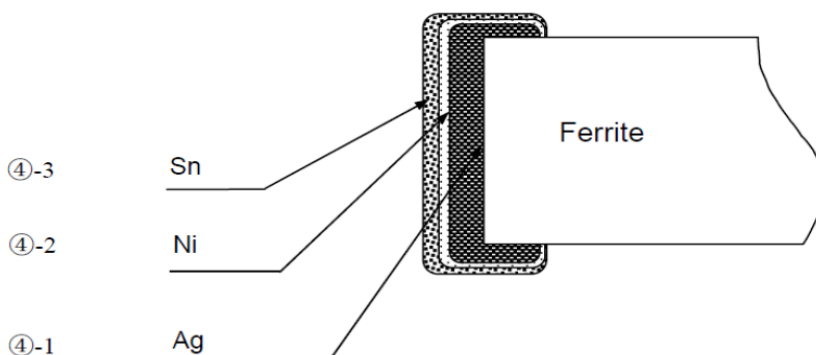

**Fig. 3 Structure of Electro-plating**

Composition/Information on the Components		
Code	Material	Main Components
①	Ceramic	Boron Silicate, Al <sub>2</sub> O <sub>3</sub> , Secret
②	Inner Coil	Silver (Ag)
③	Pull-out Electrode	Silver (Ag)
④-1	Terminal Electrode	Silver (Ag)
④-2	Electrode-plating: Nickel plating	Nickel (Ni)
④-3	Electrode-plating: Sn plating	Tin (Sn)

  

Compositions Wt Rate (Wt%) of Material		
Material	Wt Rate (Wt%)	CAS No.
Boron Silicate	51~65	65997-18-4
Al <sub>2</sub> O <sub>3</sub>	14~17	1344-28-1
Secret	0~5	-
Ag	9~29	7440-22-4
Nickel	1.8~2.3	7440-02-0
Tin	3.6~4.7	7440-31-5

◆ **TYPICAL ELECTRICAL CHARACTERISTICS**

**SCC1005 Series**

**Inductance vs. Frequency Characteristics**

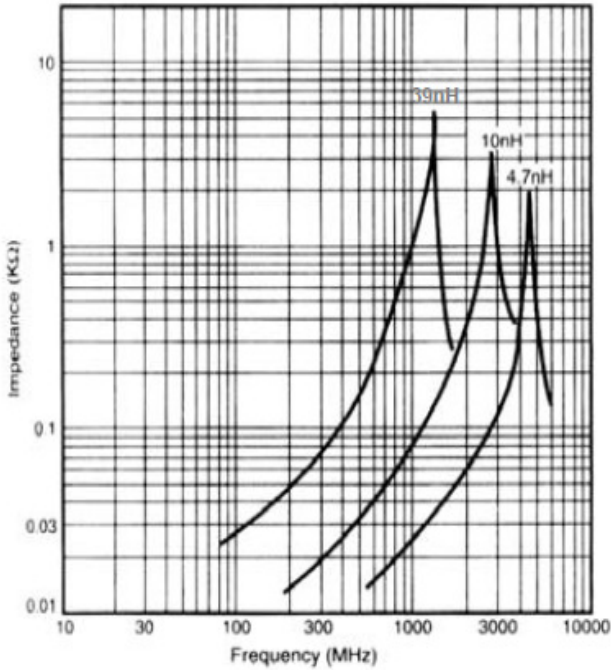

**Impedance vs. Frequency Characteristics**

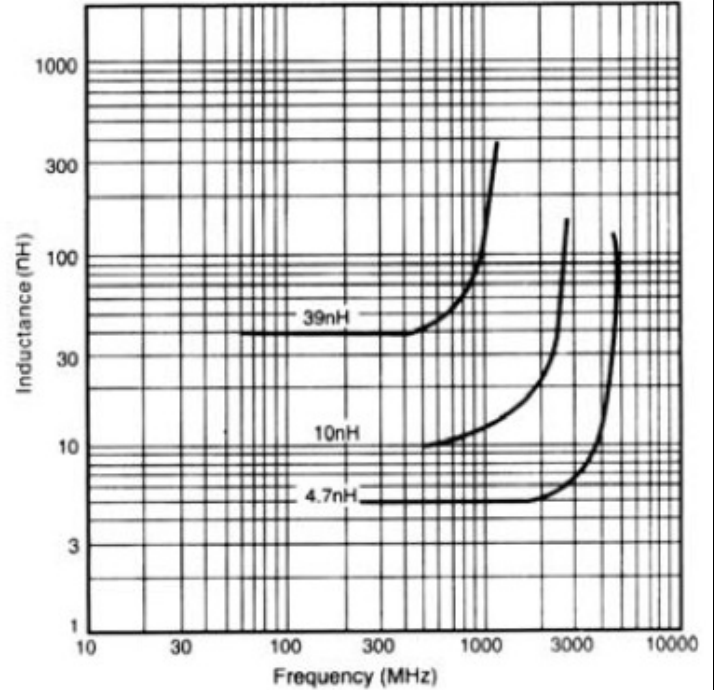

**Q vs. Frequency Characteristics**

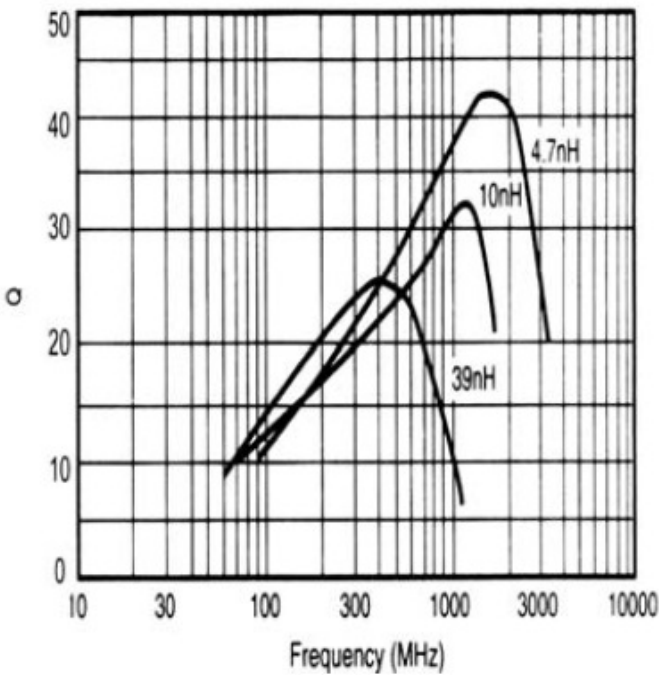

## ◆ Packaging

### (1) Taping Drawings (Unit: mm)

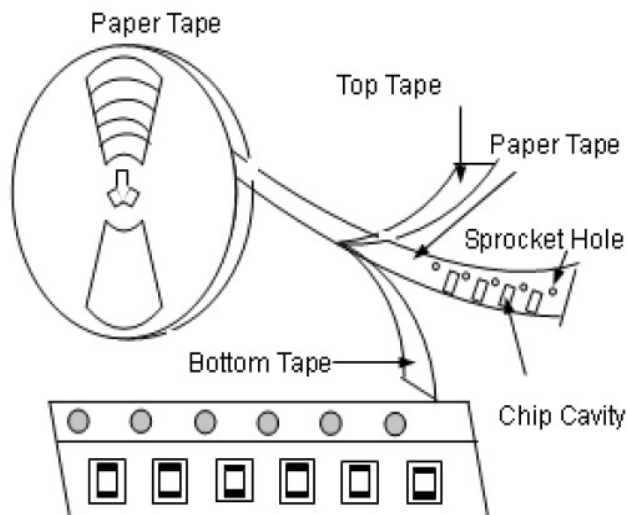

**Remark:** The sprocket holes are to the right as the tape is pulled toward the user.

### (2) Taping Dimensions (Unit: mm)

Sprocket Hole  $\Phi 1.5 (+0.1, 0)$

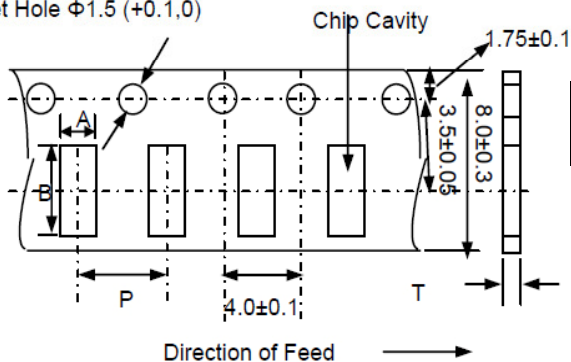

Paper Tape

Type	A	B	P	T max	Quantity
1005(0402)	0.065±0.1	1.15±0.1	2.0±0.05	0.8	10K

### (3) Reel Dimensions (Unit: mm)

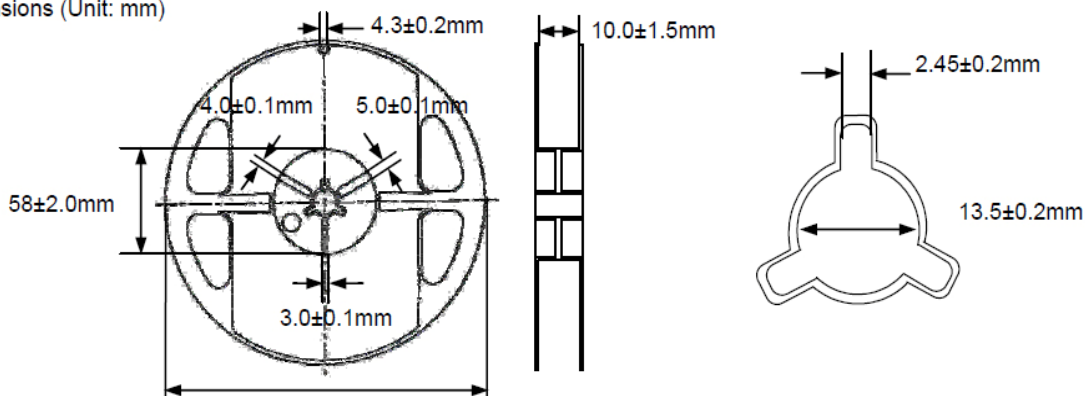

## X-ON Electronics

Largest Supplier of Electrical and Electronic Components

*Click to view similar products for [Fixed Inductors](#) category:*

*Click to view products by [Sunltech](#) manufacturer:*

Other Similar products are found below :

[CR32NP-100KC](#) [CR32NP-151KC](#) [CR32NP-180KC](#) [CR32NP-181KC](#) [CR32NP-1R5MC](#) [CR32NP-390KC](#) [CR32NP-3R9MC](#) [CR32NP-680KC](#) [CR32NP-820KC](#) [CR32NP-8R2MC](#) [CR43NP-390KC](#) [CR43NP-560KC](#) [CR43NP-680KC](#) [CR54NP-181KC](#) [CR54NP-470LC](#) [CR54NP-820KC](#) [CR54NP-8R5MC](#) [70F224AI](#) [MGDQ4-00004-P](#) [MHL1ECTTP18NJ](#) [MHQ1005P10NJ](#) [MHQ1005P1N0S](#) [MHQ1005P2N4S](#) [MHQ1005P3N6S](#) [MHQ1005P5N1S](#) [MHQ1005P8N2J](#) [PE-51506NL](#) [PE-53601NL](#) [PE-53602NL](#) [PE-53630NL](#) [PE-53824SNLT](#) [PE-92100NL](#) [PG0434.801NLT](#) [PG0936.113NLT](#) [9220-20](#) [9310-16](#) [PM06-2N7](#) [PM06-39NJ](#) [A01TK](#) [1206CS-471XJ](#) [HC2LP-R47-R](#) [HC2-R47-R](#) [HC3-2R2-R](#) [HCF1305-3R3-R](#) [1206CS-151XG](#) [RCH664NP-140L](#) [RCH664NP-4R7M](#) [RCH8011NP-221L](#) [RCP1317NP-332L](#) [RCP1317NP-391L](#)