

◆ **Scope**

This specification applies to the SLO201610T Series of SMD power inductors.

◆ **Lead Free PartNumbering**

SLO	201610	T	1R0	M	T	T
(1)	(2)	(3)	(4)	(5)	(6)	(7)

- (1) Series Type
- (2) Dimension: LxWxH
- (3) Material Code
- (4) Inductance:R68=0.68uH;1R0=1.0uH
- (5) Inductance Tolerance:M=± 20%,N=± 30%
- (6) Company Code
- (7) Packaging: packed in embossed carrier tape

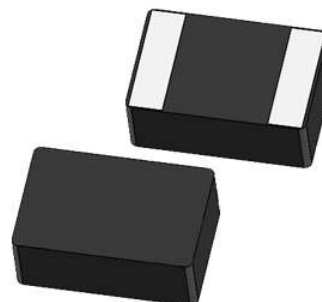

◆ **Dimensions**

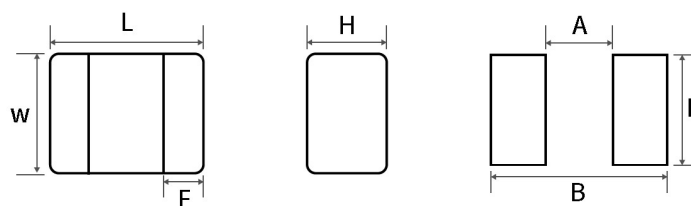

Series	L(mm)	W(mm)	H(mm)	F(mm)	Recommended Land Patterns		
					A(mm)	B(mm)	E(mm)
SLO201610T	2.0±0.2	1.6±0.2	1.0Max.	0.5Typ.	0.8Typ.	2.1Typ.	1.7Typ.

◆ **Structural drawing**

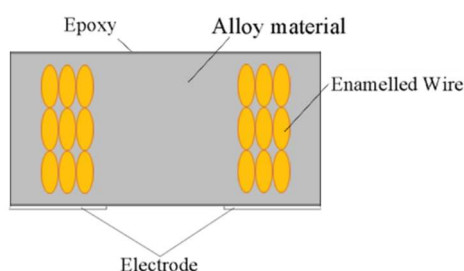

No.	Component	Material
①	Body	Alloy material
②	Winding	Enamelled Wire
③	Shield	Epoxy
④	Electric	Base plating-Cu
		Base plating-Ni
		Base plating-Sn

◆ Specification

Part No.	Inductance Ls(uH)	Direct Current Resistance DCR(mΩ)		Saturatio n Current Isat(A)	Temperature Rise Current Irms(A)
SLO201610TR24MTT	0.24±20%	17.0 Max	14.0 Typ	7.80 Max	5.60 Max
SLO201610TR33MTT	0.33±20%	22.0 Max	17.0 Typ	6.50 Max	5.30 Max
SLO201610TR47MTT	0.47±20%	25.0 Max	22.0 Typ	5.50 Max	5.00 Max
SLO201610TR68MTT	0.68±20%	32.0 Max	25.0 Typ	4.30 Max	4.70 Max
SLO201610T1R0MTT	1.0±20%	43.0 Max	35.0 Typ	4.20 Max	4.10 Max
SLO201610T1R5MTT	1.5±20%	100.0 Max	80.0 Typ	2.90 Max	2.30 Max
SLO201610T2R2MTT	2.2±20%	170.0 Max	140.0 Typ	2.80 Max	2.10 Max
SLO201610T3R3MTT	3.3±20%	130.0 Max	120.0 Typ	2.00 Max	1.50 Max
SLO201610T4R7MTT	4.7±20%	220.0 Max	190.0 Typ	1.80 Max	1.40 Max

Test condition & equipment :

Item	Test condition	Test equipment
Ls	1MHz/1V	HP4263BIM3532-50 or equivalent
DCR	direct-current	HP4263BRM3545 or equivalent
Isat	1MH/1V	Microtest 6379 &6220 or equivalent
Irms	ambient temperature 20°C	Microtest 6379 &6220 or equivalent

◆ Operating Temperature Range

-40°C~+125°C,Including self-heating

◆ Storage Conditions

Store products in a warehouse in compliance with the following condition:

Temperature: Inductors (product with taping) -10 to +40°C;

Inductors body -40 to +85°C.

Humidity: 30~70%RH

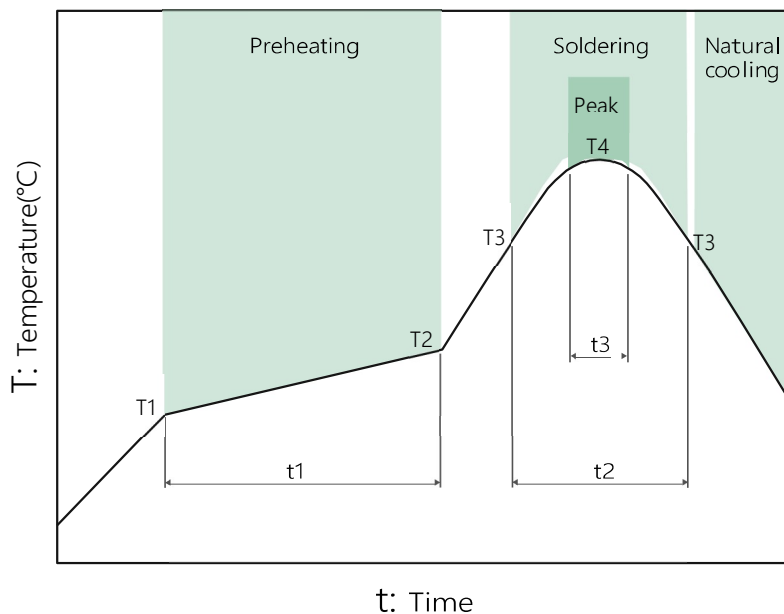
◆ RECOMMENDED REFLOW PROFILE

Preheating			Soldering		Peak	
Temp.	Time		Temp.	Time	Temp.	Time
T1	T2	t1	T3	t2	T4	t3
150°C	180°C	60 to 120s	230°C	30 to 50s	250 to 260°C	10s max

◆ Reliability Mechanical

序号 No.	项目 Items	要求 Requirements	试验方法及备注 Test Methods and Remarks
1	绝缘电阻 Insulation Resistance	$\geq 100\text{M}\Omega$	在电感器线圈和本体顶面中间施加 100 V 直流电压保持60 s。 100 V DC between inductor coil and The middle of the top surface of the body for 60 seconds.
2	可焊性 Solderability	电极面90%以上覆盖新的焊料。 90% or more of electrode area shall be coated by new solder.	在(245±5) °C熔融的焊锡 (96.5Sn/3.0Ag/0.5Cu) 中浸(5±1) s。 Dip pads in flux and dip in solder pot (96.5Sn/3.0Ag/0.5Cu) at (245±5) °C for (5±1) seconds
3	耐焊接热 Resistance to Soldering Heat	外观无可见机械损伤; 电感量变化率: ±10%以内。 No visible mechanical damage. Inductance change: Within ±10%	在(260±5) °C熔融的焊锡 (96.5Sn/3.0Ag/0.5Cu) 中浸(10±1) s。 Dip pads in flux and dip in solder pot (96.5Sn/3.0Ag/0.5Cu) at (260±5) °C for (10±1) seconds.
4	端子强度 Adhesion of terminal electrode	元件的端子与本体结合无松动、无脱落。 Strong bond between the pad and the core, without come off PC board.	将电感器用(260±5) °C, (20±5) s 焊在带有 0.3 mm厚锡膏的基板上, 然后用治具垂直电极面方向加压 10 N, (10±1) s。 Inductors shall be subjected to (260±5)°C for (20±5) s Soldering in the base whit 0.3mm solder. And then aplomb electrode way plus tax 10 N for (10±1) seconds.
5	耐高温 High temperature	外观无可见机械损伤; 电感量变化率: ±10%以内。 No visible mechanical damage. Inductance change: Within ±10%	温度(+85 ± 2) °C,时间(96±2) h; Temperature is (+85±2)°C and keep (96±2) hours.
6	耐低温 Low temperature	外观无可见机械损伤; 电感量变化率: ±10%以内。 No visible mechanical damage. Inductance change: Within ±10%	温度(-40 °C ± 2) °C, 时间(96±2) h; Temperature is (-40±2)°C and keep (96±2) hours.

序号 No.	项目 Items	要求 Requirements	试验方法及备注 Test Methods and Remarks
7	温度变化 Thermal shock	外观无可见机械损伤; 电感量变化率: ±10%以内。 No visible mechanical damage. Inductance change: Within ±10%	(-40±3) °C, 时间(30±3) min ↔ (125°C±2) °C/(30±3) min, 转换时间(2~3) min, 循环32次; 在室温下放置 2 小时后、48 小时内测试。 The test sample shall be placed at (-40±3)°C and (125±2)°C for (30±3) min, different temperature conversion time is 2~3 minutes. The temperature cycle shall be repeated 32 cycles. Placed at room
8	温度特性 Temperature characteristic	电感量变化率 P_{c-b}, P_{c-d} 不超过 ±20%。 Inductance change P_{c-b}, P_{c-d} : Within ±20%	a: +20 °C (30~45) min → b: -40 °C (30~45) min → c: +20 °C (30~45) min → d: +125 °C (30~45) min → e: +20 °C (30~45) min $P_{c-b} = \frac{L_b - L_c}{L_c} \times 100\%$; $P_{c-d} = \frac{L_d - L_c}{L_c} \times 100\%$
9	恒定湿热 Static Humidity	外观无可见机械损伤; 电感量变化率: ±10%以内。 No visible mechanical damage. Inductance change: Within ±10%	(93±3)%RH . at (60±2)°C for (96±2) h . Placed at room temperature
10	耐久性 (寿命) Life	外观无可见机械损伤; 电感量变化率: ±10%以内。 No visible mechanical damage. Inductance change: Within ±10%	温度(85±2)°C, 时间(1000±24) h, 施加 Irms, 在室温下放置2 小时后、48 小时内测试。 Inductors shall be store at (85±2)°C for (1000±24) hours with Irms applied. Placed at room temperature for 2 hours, within 48 hours of testing.

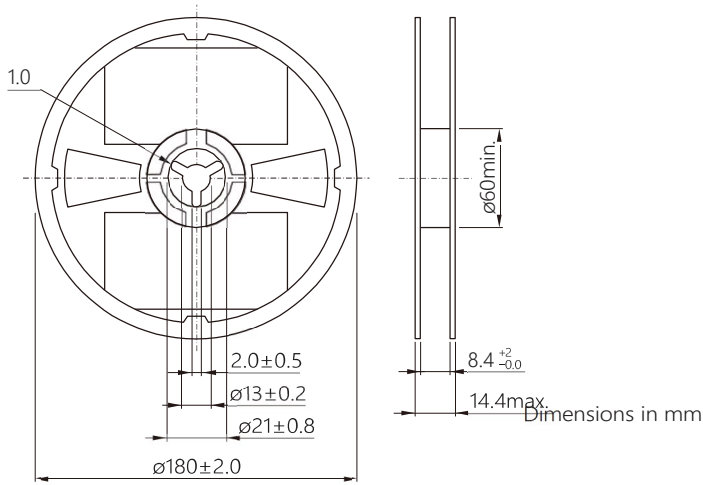
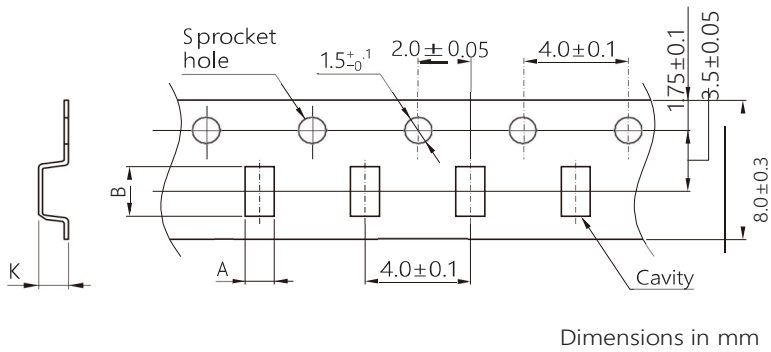
◆ Taping reel dimensions

◆ Carrier tape dimensions

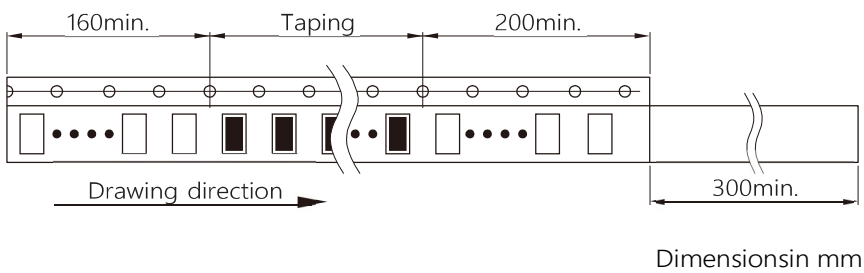
Series Type	A	B	K
SLO201610T	2.2	2.7	1.3

◆ Package quantity

Package quantity	3000 pcs/reel
------------------	---------------

X-ON Electronics

Largest Supplier of Electrical and Electronic Components

Click to view similar products for [Fixed Inductors](#) category:

Click to view products by [Sunltech](#) manufacturer:

Other Similar products are found below :

[CR32NP-100KC](#) [CR54NP-470LC](#) [70F224AI](#) [MGDQ4-00004-P](#) [MHQ1005P10NJ](#) [MHQ1005P1N0S](#) [MHQ1005P2N4S](#) [MHQ1005P3N6S](#)
[MHQ1005P5N1S](#) [MHQ1005P8N2J](#) [PE-53601NL](#) [PE-53602NL](#) [PG0936.113NLT](#) [9220-20](#) [9310-16](#) [PM06-2N7](#) [PM06-39NJ](#) [A01TK](#)
[1206CS-471XJ](#) [HC2-R47-R](#) [HC8-1R2-R](#) [HCF1305-3R3-R](#) [1206CS-151XG](#) [RCH664NP-140L](#) [RCH664NP-4R7M](#) [RCP1317NP-391L](#)
[RCR110DNP-331L](#) [DH2280-4R7M](#) [DS1608C-106](#) [B10TJ](#) [B82498B3101J000](#) [ELJ-RE27NJF2](#) [1812CS-153XJ](#) [1812CS-183XJ](#) [1812CS-](#)
[223XJ](#) [1812LS-104XJ](#) [1812LS-105XJ](#) [1812LS-124XJ](#) [1812LS-154XJ](#) [1812LS-223XJ](#) [1812LS-224XJ](#) [1812LS-563XJ](#) [1812LS-683XJ](#)
[1812LS-824XJ](#) [NIN-FB101JTR110F](#) [NIN-FB471JTR62F](#) [NIN-FC1R5JTR220F](#) [NIN-HCR15JTRF](#) [NIN-HCR33JTRF](#) [NIN-HDR22JTRF](#)