

SHAPE & DIMENSION (UNIT:mm)

PAD LAYOUT(MM):

Recommended land pattern

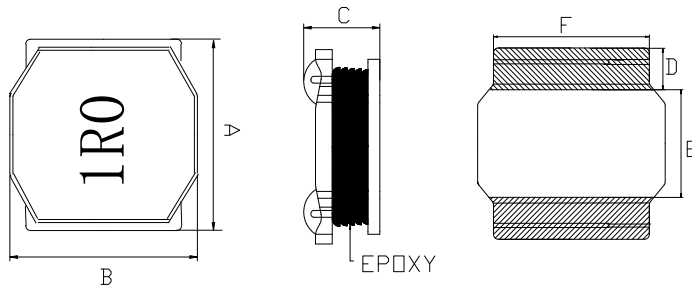
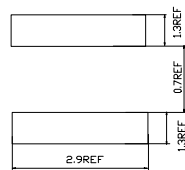

ELECREICAL SCHEMATIC:

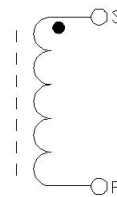
ELECREICAL SPECIFICATION

MEAS. ITEM	SPEC.				TEST FREQ.	CONDITIONS
L	1.0	μH	±	20%	1MHz//1V	Ta=25°C, Idc=0A
DCR	85	mΩ	Max.			Ta=25°C
Isat	4.4	A	Max.		100KHz//1V	ΔL/L≤30%
Irms	3.2	A	Max.		100KHz//1V	ΔT≤40°C

GENERAL SPECIFICATION

Electrical specifications :	at 25°C
Operation Temperature:	-40~+125°C
Storage Temperature:	-40~+125°C
(1)WIRE TYPE:H ∅ 0.15mm	
(2)WINDING:7.5Ts(REF)	

Isat(飽和電流):電感瞬間的突波電流

TME(秒)	Lsat(A)	L(UH)	$\Delta L/L(\%)$
1	0.00	0.97	0.00
1	0.50	0.95	2.06
1	1.00	0.92	5.15
1	1.50	0.90	7.21
1	2.00	0.90	7.21
1	2.50	0.89	8.24
1	3.00	0.87	10.3
1	3.50	0.85	12.3
1	4.00	0.80	17.5
1	4.50	0.78	19.5
1	5.00	0.75	22.6

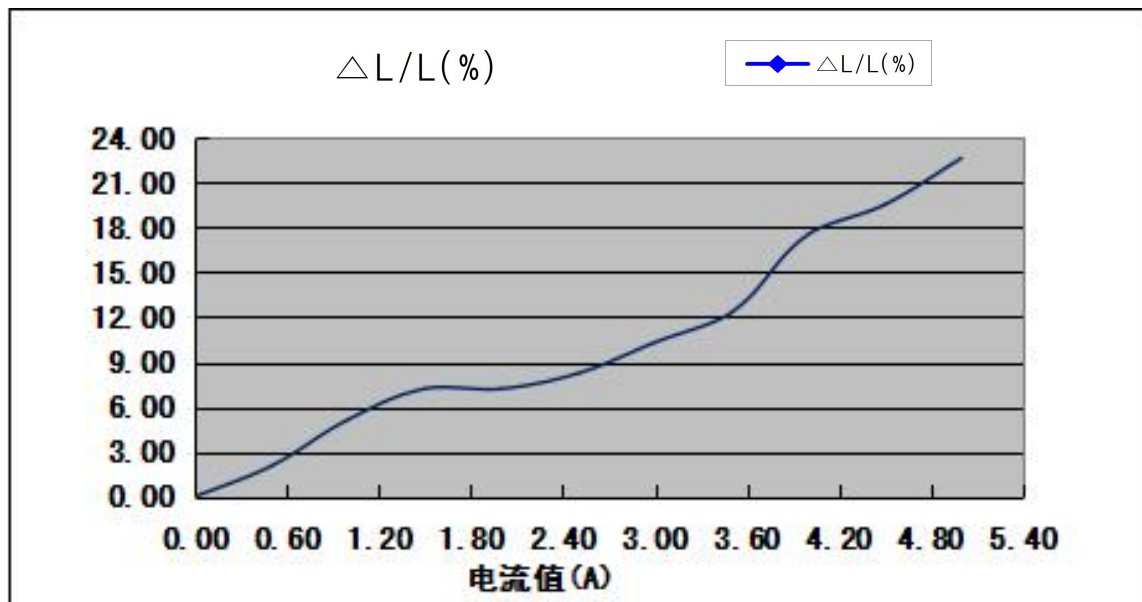

單點溫昇

TIME(S)	I _{rms} (A)	L(uH)	ΔL/L(%)	Temp(°C)	ΔT(°C)
0	0.00	0.97	0.00	22.0	0.00
30	0.50	0.95	2.06	25.6	3.60
30	1.00	0.92	5.15	28.4	6.40
30	1.50	0.90	7.21	31.4	9.40
30	2.00	0.90	7.21	39.6	17.6
30	2.50	0.89	8.24	47.1	25.1
30	3.00	0.87	10.3	56.9	34.9
30	3.50	0.85	12.3	70.0	48.0
30	4.00	0.80	17.5	84.7	62.7
30	4.50	0.78	19.5	146	124
30	5.00	0.75	22.6		

※DC bias current characteristics in the ambient temperature 25°C Frequency 100KHz/1V

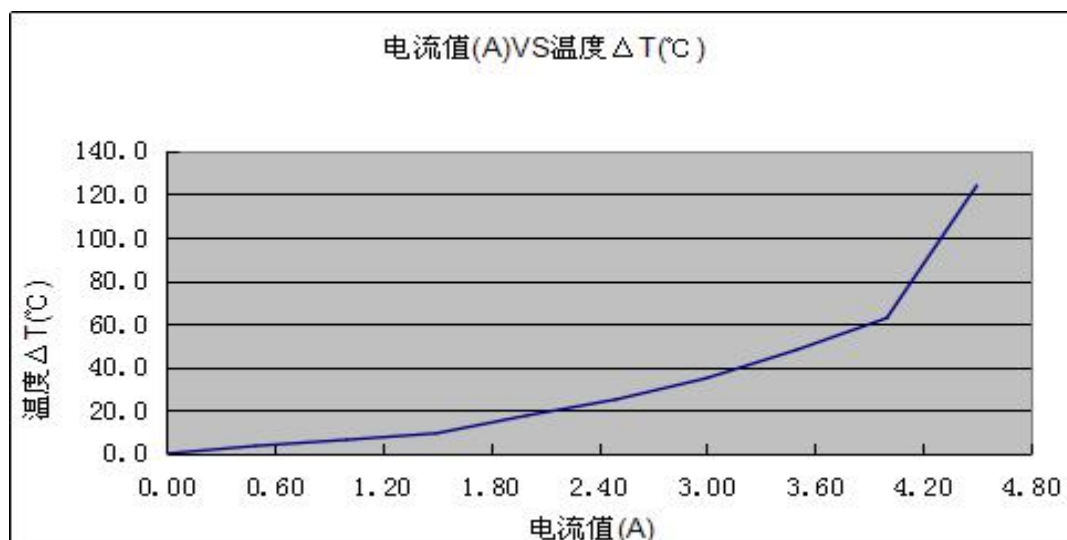

TEST DATA FOR PREPRODUCTION SAMPLE

TEST RESOLUTION					DIMENSION (Unit: mm)		
MEAS.					长	宽	高
ITEM	μH	mΩ					
SPEC.	1.0	85			3.0±0.2	3.0±0.2	1.5MAX
	±	max					
	20%						
TEST FREQ.	1MHz/1V		Isat 4.4A	$\Delta L/L \leq 30\%$	mm	mm	mm
1	0.99	50.3	0.94	8.74	3.01	3.00	1.38
2	1.00	49.0	0.94	12.15	3.02	3.00	1.40
3	0.99	49.0	0.97	7.62	3.00	3.03	1.41
4	0.92	48.3	0.92	7.07	3.00	3.02	1.40
5	1.02	49.1	0.89	5.32	3.02	3.01	1.40
6							
7							
8							
9							
10							
AVG.	0.98	49.1	0.93	8.18	3.01	3.01	1.40
R	0.10	2.00	0.08	6.83	0.02	0.03	0.03

PACKAGING

包装

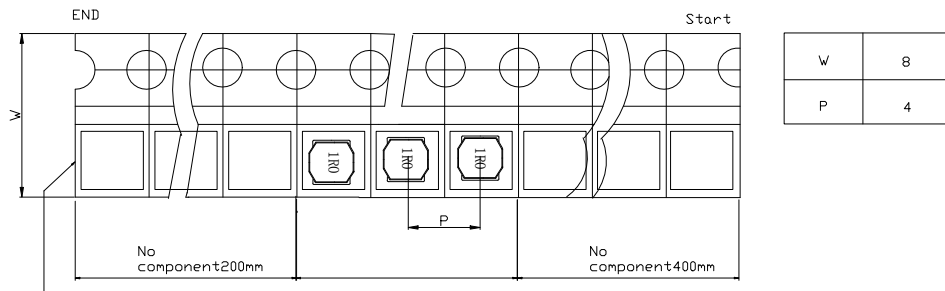

Packaging Quantity: **2,000** PCS/REEL

Reel dimensions

UNIT : mm

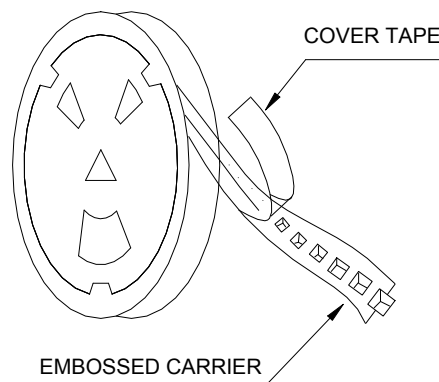
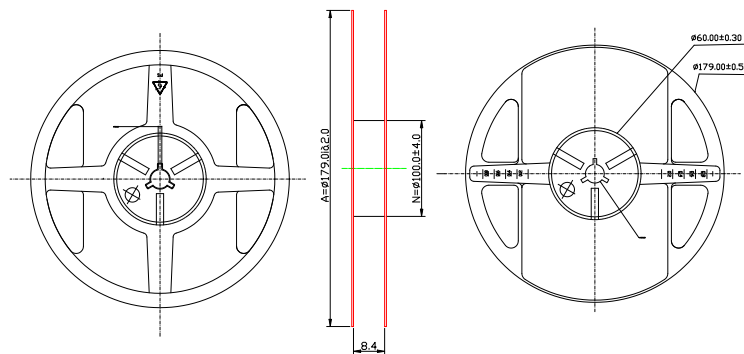

X-ON Electronics

Largest Supplier of Electrical and Electronic Components

Click to view similar products for [Fixed Inductors](#) category:

Click to view products by [Sunltech](#) manufacturer:

Other Similar products are found below :

[MLZ1608M6R8WTD25](#) [MLZ1608N6R8LT000](#) [MLZ1608N3R3LTD25](#) [MLZ1608N3R3LT000](#) [MLZ1608N150LT000](#)

[MLZ1608M150WTD25](#) [MLZ1608M3R3WTD25](#) [MLZ1608M3R3WT000](#) [MLZ1608M150WT000](#) [MLZ1608A1R5WT000](#)

[MLZ1608N1R5LT000](#) [B82432C1333K000](#) [PCMB053T-1R0MS](#) [PCMB053T-1R5MS](#) [PCMB104T-1R5MS](#) [CR32NP-100KC](#) [CR32NP-](#)

[151KC](#) [CR32NP-180KC](#) [CR32NP-181KC](#) [CR32NP-1R5MC](#) [CR32NP-390KC](#) [CR32NP-3R9MC](#) [CR32NP-680KC](#) [CR32NP-820KC](#)

[CR32NP-8R2MC](#) [CR43NP-390KC](#) [CR43NP-560KC](#) [CR43NP-680KC](#) [CR54NP-181KC](#) [CR54NP-470LC](#) [CR54NP-820KC](#) [CR54NP-8R5MC](#)

[MGDQ4-00004-P](#) [MGDU1-00016-P](#) [MHL1ECTTP18NJ](#) [MHL1JCTTD12NJ](#) [PE-51506NL](#) [PE-53601NL](#) [PE-53630NL](#) [PE-53824SNLT](#) [PE-](#)

[62892NL](#) [PE-92100NL](#) [PG0434.801NLT](#) [PG0936.113NLT](#) [PM06-2N7](#) [PM06-39NJ](#) [HC2LP-R47-R](#) [HC2-R47-R](#) [HC3-2R2-R](#) [HC8-1R2-R](#)