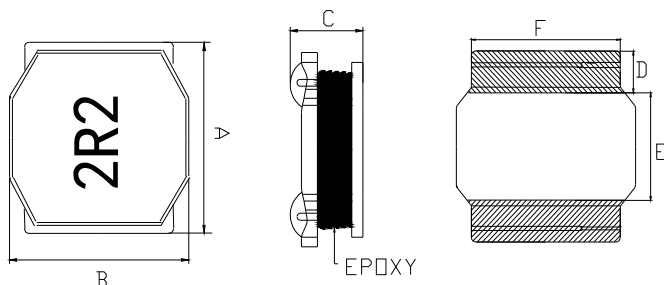
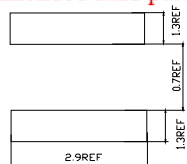
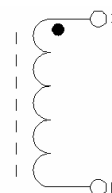

SHAPE & DIMENSION (UNIT:mm)

PAD LAYOUT(MM):
Recommended land pattern

ELECTRICAL SCHEMATIC:

ELECTRICAL SPECIFICATION

MEAS. ITEM	SPEC.				TEST FREQ.	CONDITIONS
L	2.2	μH	±	20%	1MHz//1V	Ta=25℃, Idc=0A
DCR	120	mΩ	Max.			Ta=25℃
Isat	2.3	A	Max.		100KHz//1V	ΔL/L ≤ 30%
Irms	2.0	A	Max.		100KHz//1V	ΔT ≤ 40℃

GENERAL SPECIFICATION

Electrical specifications :	at 25℃
Operation Temperature:	-40~+125℃
Storage Temperature:	-40~+125℃
(1) WIRE TYPE: H∅ 0.14mm	
(2) WINDING: 11.5Ts (REF)	

Isat(飽和電流):電感瞬間的突波電流

TME(秒)	Lsat(A)	L(UH)	$\Delta L/L(\%)$
1	0.0	1.89	0.00
1	0.5	1.88	0.52
1	1.0	1.88	0.52
1	1.5	1.88	0.52
1	2.0	1.83	3.17
1	2.5	1.74	7.93
1	3.0	1.74	7.93
1	3.5	1.70	10.00
1	4.0	1.63	13.70
1	4.5	1.57	16.90
1	5.0	1.49	21.10

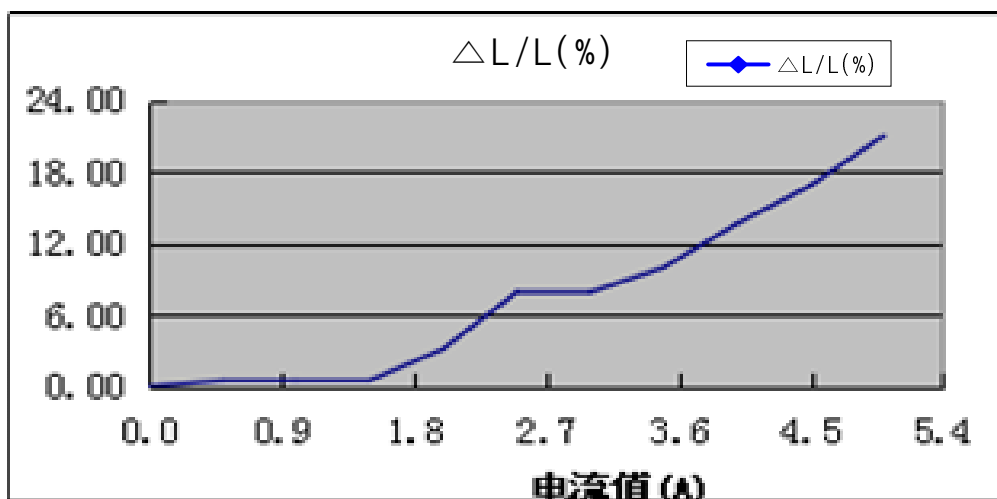

單點溫昇

TIME(S)	Irms(A)	L(uH)	$\Delta L/L(\%)$	Temp($^{\circ}\text{C}$)	$\Delta T(^{\circ}\text{C})$
0	0.0	1.89	0.00	25.0	0.0
30	0.5	1.88	0.52	26.9	1.9
30	1.0	1.88	0.52	30.9	5.9
30	1.5	1.88	0.52	38.1	13.1
30	2.0	1.83	3.17	47.7	22.7
30	2.5	1.74	7.93	55.5	30.5
30	3.0	1.74	7.93	88.7	63.7
30	3.5	1.70	10.00	132.0	107.0
30	4.0	1.63	13.70	162.0	137.0
30	4.5	1.57	16.90		
30	5.0	1.49	21.10		

※DC bias current characteristics in the ambient temperature 25 $^{\circ}\text{C}$ Frequency 100KHz/1V

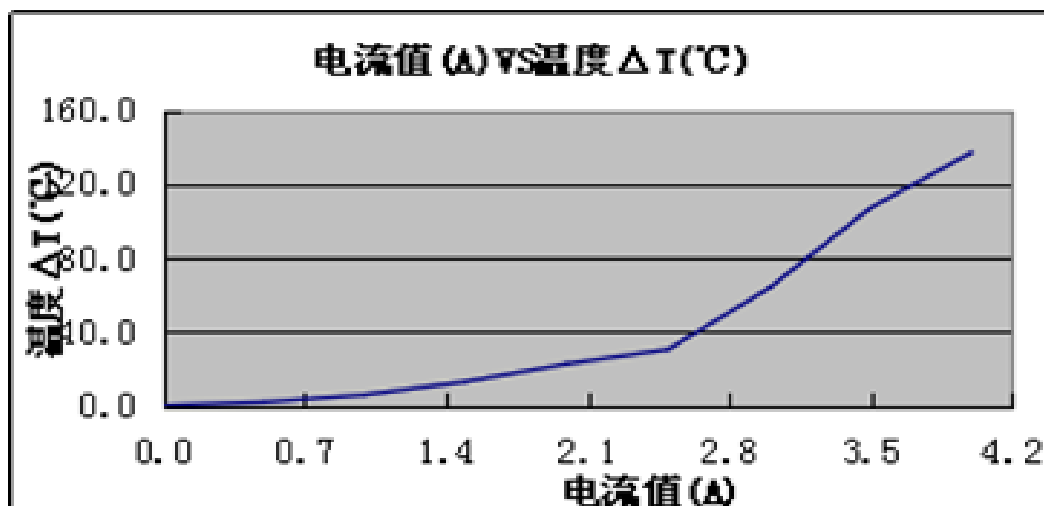

TEST DATA FOR PREPRODUCTION SAMPLE

TEST RESOLUTION					DIMENSION (Unit: mm)		
MEAS.							
ITEM	μH	mΩ			长	宽	高
SPEC.	2.2	120			3.0±0.2	3.0±0.2	1.5MAX
	±	max					
	20%						
TEST	1MHz/1V		Isat 2.3A	ΔL/L ≤ 30%	mm	mm	mm
FREQ.							
1	2.02	89.4	1.89	16.37	3.00	3.00	1.43
2	2.06	90.2	1.89	16.74	3.00	3.00	1.42
3	1.99	88.6	1.86	6.53	3.01	3.01	1.43
4	1.98	86.0	1.91	18.72	3.03	3.00	1.44
5	1.98	90.2	1.94	17.45	3.04	3.00	1.38
6							
7							
8							
9							
10							
AVG.	2.01	88.9	1.90	15.16	3.02	3.00	1.42
R	0.06	9.40	0.08	12.19	0.04	0.01	0.06

PACKAGING

包装

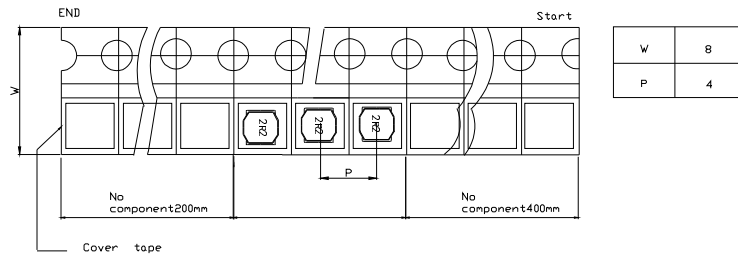

Packaging
Quantity : **2,000** pcs/reel

Reel dimensions

UNIT : mm

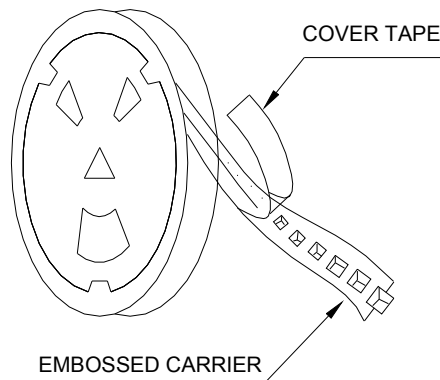
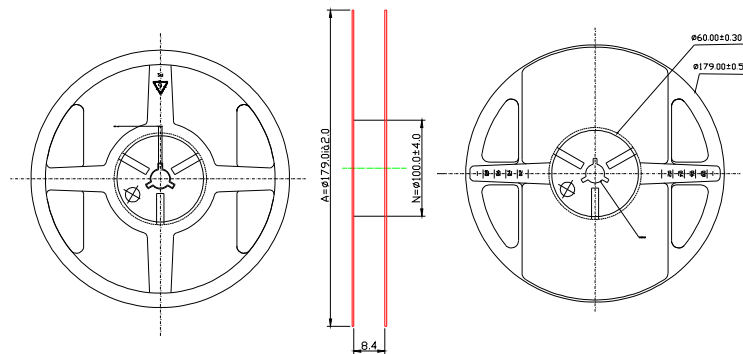

X-ON Electronics

Largest Supplier of Electrical and Electronic Components

Click to view similar products for [Fixed Inductors](#) category:

Click to view products by [Sunltech](#) manufacturer:

Other Similar products are found below :

[MLZ1608M6R8WTD25](#) [MLZ1608N6R8LT000](#) [MLZ1608N3R3LTD25](#) [MLZ1608N3R3LT000](#) [MLZ1608N150LT000](#)

[MLZ1608M150WTD25](#) [MLZ1608M3R3WTD25](#) [MLZ1608M3R3WT000](#) [MLZ1608M150WT000](#) [MLZ1608A1R5WT000](#)

[MLZ1608N1R5LT000](#) [B82432C1333K000](#) [PCMB053T-1R0MS](#) [PCMB053T-1R5MS](#) [PCMB104T-1R5MS](#) [CR32NP-100KC](#) [CR32NP-](#)

[151KC](#) [CR32NP-180KC](#) [CR32NP-181KC](#) [CR32NP-1R5MC](#) [CR32NP-390KC](#) [CR32NP-3R9MC](#) [CR32NP-680KC](#) [CR32NP-820KC](#)

[CR32NP-8R2MC](#) [CR43NP-390KC](#) [CR43NP-560KC](#) [CR43NP-680KC](#) [CR54NP-181KC](#) [CR54NP-470LC](#) [CR54NP-820KC](#) [CR54NP-8R5MC](#)

[MGDQ4-00004-P](#) [MGDU1-00016-P](#) [MHL1ECTTP18NJ](#) [MHL1JCTTD12NJ](#) [PE-51506NL](#) [PE-53601NL](#) [PE-53630NL](#) [PE-53824SNLT](#) [PE-](#)

[62892NL](#) [PE-92100NL](#) [PG0434.801NLT](#) [PG0936.113NLT](#) [PM06-2N7](#) [PM06-39NJ](#) [HC2LP-R47-R](#) [HC2-R47-R](#) [HC3-2R2-R](#) [HC8-1R2-R](#)