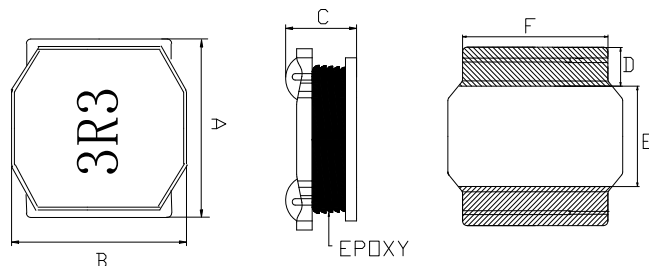
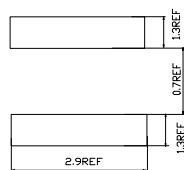
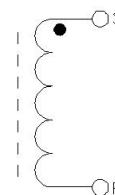

**SHAPE & DIMENSION (UNIT:mm)**

**PAD LAYOUT(MM):**

Recommended land pattern

**ELECTRICAL SCHEMATIC:**

**ELECTRICAL SPECIFICATION**

MEAS. ITEM	SPEC.				TEST FREQ.	CONDITIONS
<b>L</b>	<b>3.3</b>	<b>μH</b>	<b>±</b>	<b>20%</b>	<b>100KHz//0.25V</b>	<b>Ta=25°C, Idc=0A</b>
<b>DCR</b>	<b>169</b>	<b>mΩ</b>	<b>Max.</b>			<b>Ta=25°C</b>
<b>Isat</b>	<b>2.4</b>	<b>A</b>	<b>Max.</b>		<b>100KHz//0.25V</b>	<b>ΔL/L ≤ 30%</b>
<b>Irms</b>	<b>2.0</b>	<b>A</b>	<b>Max.</b>		<b>100KHz//0.25V</b>	<b>ΔT ≤ 40°C</b>

**GENERAL SPECIFICATION**

Electrical specifications :	<b>at 25°C</b>
Operation Temperature:	<b>-40~+125°C</b>
Storage Temperature:	<b>-40~+125°C</b>
(1)WIRE TYPE: <b>H ∅ 0.13mm</b>	
(2)WINDING: <b>13.5Ts(REF)</b>	

**Isat(飽和電流):電感瞬間的突波電流**

TME(秒)	Lsat(A)	L(UH)	$\Delta L/L(\%)$
1	0.0	3.29	0.00
1	0.3	3.28	0.30
1	0.6	3.26	0.91
1	0.9	3.23	1.82
1	1.2	3.19	3.03
1	1.5	3.14	4.55
1	1.8	3.08	6.38
1	2.1	3.01	8.51
1	2.4	2.94	10.6
1	2.7	2.87	12.7
1	3.0	2.48	24.6

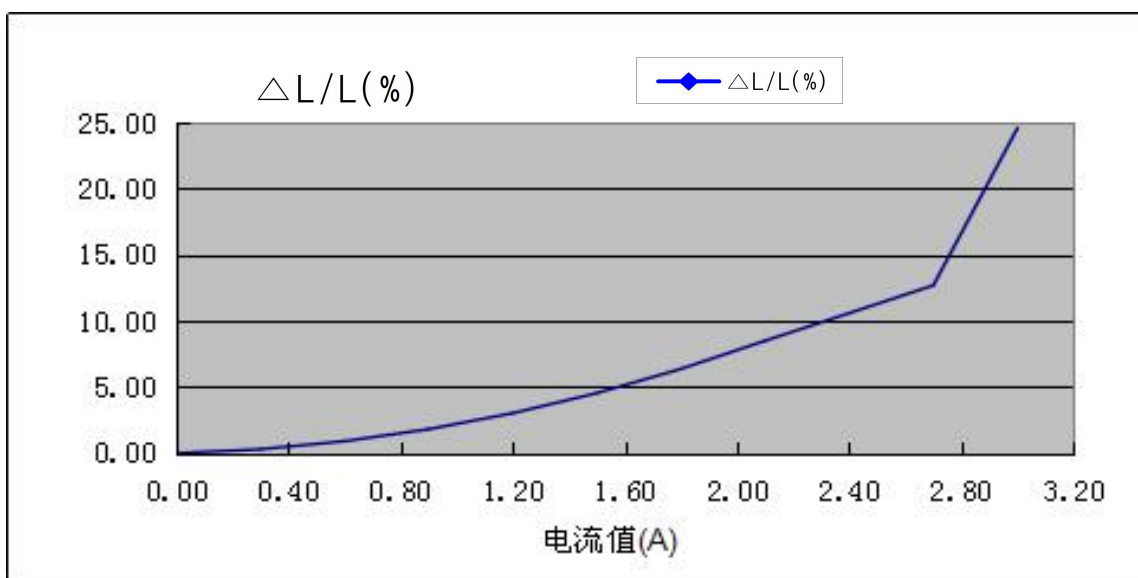

**單點溫昇**

TIME(S)	I <sub>rms</sub> (A)	L(uH)	ΔL/L(%)	Temp(°C)	ΔT(°C)
0	0.0	3.29	0.00	28.0	0.0
30	0.3	3.28	0.30	28.2	0.2
30	0.6	3.26	0.91	29.6	1.6
30	0.9	3.23	1.82	32.8	4.8
30	1.2	3.19	3.03	36.3	8.3
30	1.5	3.14	4.55	40.1	12.1
30	1.8	3.08	6.38	49.7	21.7
30	2.1	3.01	8.51	58.7	30.7
30	2.4	2.94	10.6	73.0	45.0
30	2.7	2.87	12.7	88.2	60.2
30	3.0	2.48	24.6	118.4	90.4

※DC bias current characteristics in the ambient temperature 25°C Frequency 100KHz/0.25V

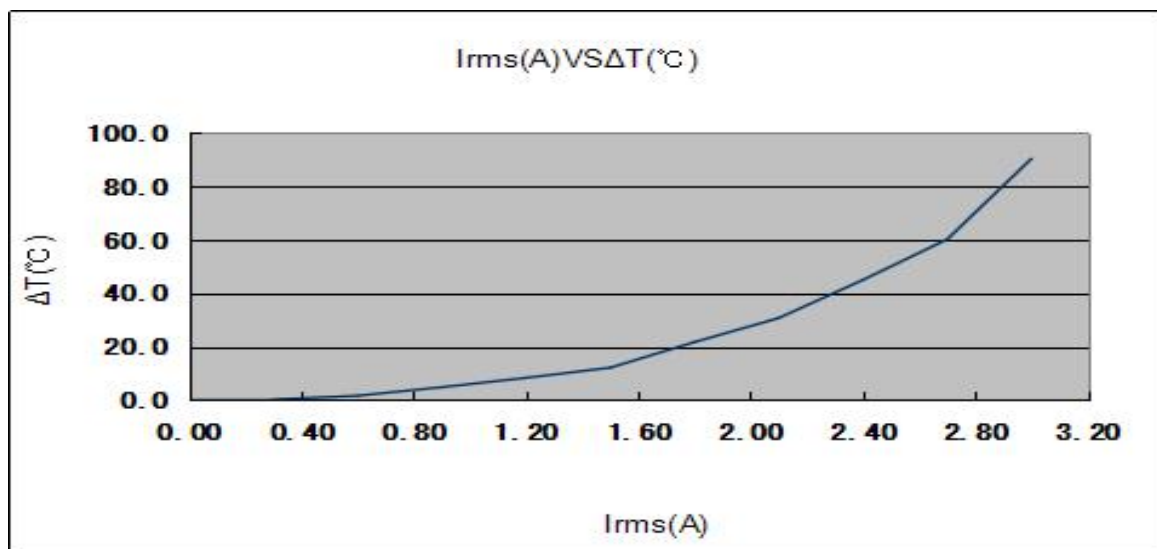

**TEST DATA FOR PREPRODUCTION SAMPLE**

TEST RESOLUTION					DIMENSION (Unit: mm)		
MEAS.							
ITEM	$\mu\text{H}$	$\text{m}\Omega$			长	宽	高
SPEC.	3.3	169			3.0±0.2	3.0±0.2	1.5MAX
	±	max					
	20%						
TEST FREQ.	100KHz/0.25V		Isat 2.4A	$\Delta L/L \leq 30\%$	mm	mm	mm
1	3.32	124	2.93	12.2	3.02	3.02	1.43
2	3.30	125	2.85	11.4	3.02	3.07	1.42
3	3.26	126	3.00	11.7	3.01	3.03	1.37
4	3.26	125	2.89	11.6	3.02	3.03	1.43
5	3.37	129	2.98	11.0	3.03	3.06	1.39
6							
7							
8							
9							
10							
AVG.	<b>3.28</b>	<b>125</b>	<b>2.93</b>	<b>11.5</b>	3.02	3.04	1.40
R	<b>0.11</b>	<b>5.0</b>	<b>0.15</b>	<b>1.20</b>	0.02	0.05	0.06

**PACKAGING**

包装

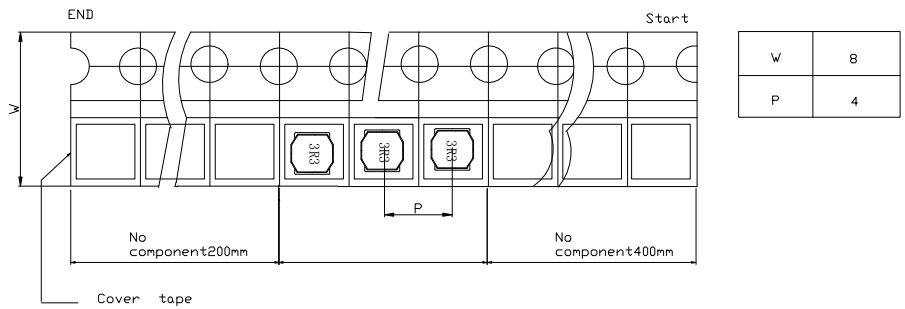
 Packaging Quantity: **2,000** pcs/reel

Reel dimensions

UNIT:mm

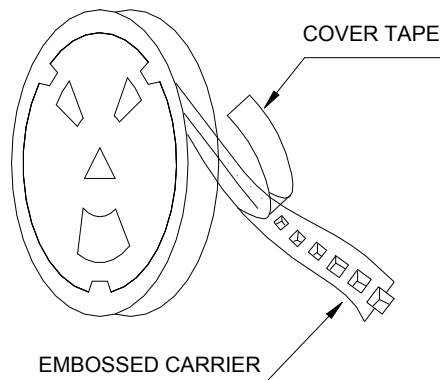
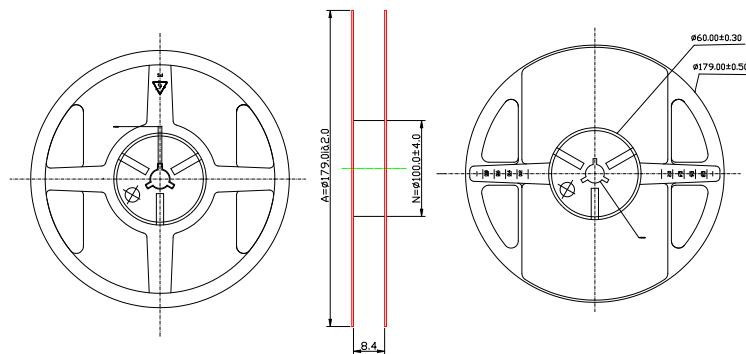

## X-ON Electronics

Largest Supplier of Electrical and Electronic Components

*Click to view similar products for [Fixed Inductors](#) category:*

*Click to view products by [Sunltech](#) manufacturer:*

Other Similar products are found below :

[MLZ1608M6R8WTD25](#) [MLZ1608N6R8LT000](#) [MLZ1608N3R3LTD25](#) [MLZ1608N3R3LT000](#) [MLZ1608N150LT000](#)  
[MLZ1608M150WTD25](#) [MLZ1608M3R3WTD25](#) [MLZ1608M3R3WT000](#) [MLZ1608M150WT000](#) [MLZ1608A1R5WT000](#)  
[MLZ1608N1R5LT000](#) [B82432C1333K000](#) [PCMB053T-1R0MS](#) [PCMB053T-1R5MS](#) [PCMB104T-1R5MS](#) [CR32NP-100KC](#) [CR32NP-151KC](#) [CR32NP-180KC](#) [CR32NP-181KC](#) [CR32NP-1R5MC](#) [CR32NP-390KC](#) [CR32NP-3R9MC](#) [CR32NP-680KC](#) [CR32NP-820KC](#)  
[CR32NP-8R2MC](#) [CR43NP-390KC](#) [CR43NP-560KC](#) [CR43NP-680KC](#) [CR54NP-181KC](#) [CR54NP-470LC](#) [CR54NP-820KC](#) [CR54NP-8R5MC](#)  
[MGDQ4-00004-P](#) [MGDU1-00016-P](#) [MHL1ECTTP18NJ](#) [MHL1JCTTD12NJ](#) [PE-51506NL](#) [PE-53601NL](#) [PE-53630NL](#) [PE-53824SNLT](#) [PE-62892NL](#) [PE-92100NL](#) [PG0434.801NLT](#) [PG0936.113NLT](#) [PM06-2N7](#) [PM06-39NJ](#) [HC2LP-R47-R](#) [HC2-R47-R](#) [HC3-2R2-R](#) [HC8-1R2-R](#)