

## Wire Wound SMD Power Inductor

### ◆ Features

- 1、Magnetic-resin shielded construction reduces buzz noise to ultra-low levels;
- 2、Metallization on ferrite core results in excellent shock resistance and damage-free durability;
- 3、Closed magnetic circuit design reduces leakage flux and Electro Magnetic Interference (EMI);
- 4、30% higher current rating than conventional inductors of equal size;
- 5、Take up less PCB real estate and save more power.



### ◆ Applications

- 1、LED Lighting;
- 2、Mobile devices with multifunction such as adding color TV and camera;
- 3、Flat-screen TVs, blue-ray disc recorders, set top boxes;
- 4、Notebooks, desktop computers, servers, graphic cards;
- 5、Portable gaming devices, personal navigation systems, personal multimedia devices;
- 6、Automotive systems
- 7、Telecomm base stations

### ◆ Lead Free Part Numbering

**SLW 4020 S 100 M S T**  
**(1) (2) (3) (4) (5) (6) (7)**

- (1) Series Type
- (2) Dimension: L X H
- (3) Material Code
- (4) Inductance: 2R2=2.2 $\mu$ H ;  
100=10 $\mu$ H; 101=100 $\mu$ H
- (5) Inductance Tolerance: M=±20%, N=±30%
- (6) Company Code
- (7) Packaging : Tape Carrier Package

### ◆ Dimensions

SLW 252010/252012 Series

Recommended Land Pattern

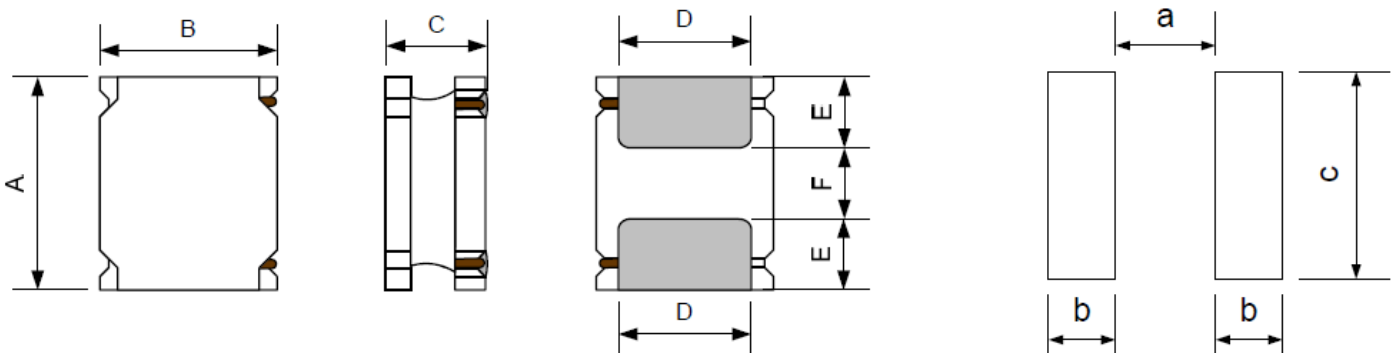

## ◆ Dimensions

SLW 30/40/50/60/80 Series

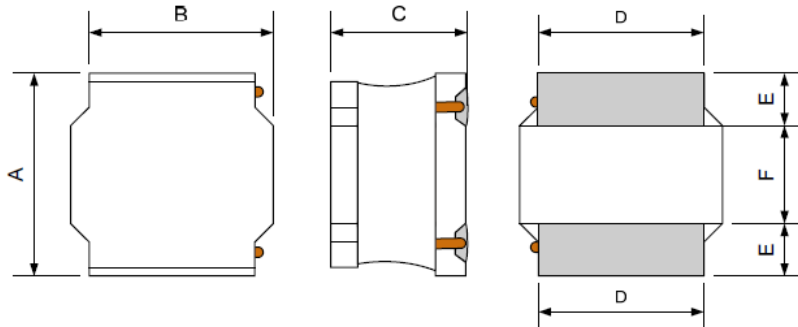

Unit:mm

Series	A	B	C	D	E	F	a Typ.	b Typ.	c Typ.
SLW252010	2.5±0.1	2.0±0.1	1.0Max.	1.5±0.2	0.80±0.2	0.80±0.2	0.8	0.85	2.0
SLW252012	2.5±0.1	2.0±0.1	1.2Max.	1.5±0.2	0.80±0.2	0.80±0.2	0.8	0.85	2.0
SLW3010	3.0±0.2	3.0±0.2	1.0Max.	2.5±0.2	0.75±0.2	1.50±0.2	1.5	0.8	2.7
SLW3012	3.0±0.2	3.0±0.2	1.2Max.	2.5±0.2	0.75±0.2	1.50±0.2	1.5	0.8	2.7
SLW3015	3.0±0.2	3.0±0.2	1.5Max.	2.5±0.2	0.75±0.2	1.50±0.2	1.5	0.8	2.7
SLW4012	4.0±0.2	4.0±0.2	1.2Max.	3.3±0.2	0.95±0.2	2.10±0.2	1.9	1.1	3.7
SLW4018	4.0±0.2	4.0±0.2	1.8Max.	3.3±0.2	0.95±0.2	2.10±0.2	1.9	1.1	3.7
SLW4020	4.0±0.2	4.0±0.2	2.0Max.	3.3±0.2	0.95±0.2	2.10±0.2	1.9	1.1	3.7
SLW4030	4.0±0.2	4.0±0.2	3.0Max.	3.3±0.2	0.95±0.2	2.10±0.2	1.9	1.1	3.7
SLW5020	5.0±0.2	5.0±0.2	2.0Max.	4.0±0.2	1.25±0.2	2.50±0.2	2.1	1.5	4.4
SLW5040	5.0±0.2	5.0±0.2	4.0Max.	4.0±0.2	1.25±0.2	2.50±0.2	2.1	1.5	4.4
SLW6020	6.0±0.3	6.0±0.3	2.0Max.	4.9±0.3	1.55±0.3	2.90±0.3	2.8	1.7	5.7
SLW6028	6.0±0.3	6.0±0.3	2.8Max.	4.9±0.3	1.55±0.3	2.90±0.3	2.8	1.7	5.7
SLW6045	6.0±0.3	6.0±0.3	4.5Max.	4.9±0.3	1.55±0.3	2.90±0.3	2.8	1.7	5.7
SLW8040	8.0±0.3	8.0±0.3	4.2Max.	6.3±0.3	2.00±0.3	4.00±0.3	3.8	2.2	7.5

## ◆ External Dimensions(L×W×H) [mm]

Series	L×W×H	Series	L×W×H
SLW252010	2.5×2.0×1.0	SLW4030	4.0×4.0×3.0
SLW252012	2.5×2.0×1.2	SLW5020	5.0×5.0×2.0
SLW3010	3.0×3.0×1.0	SLW5040	5.0×5.0×4.0
SLW3012	3.0×3.0×1.2	SLW6020	6.0×6.0×2.0
SLW3015	3.0×3.0×1.5	SLW6028	6.0×6.0×2.8
SLW4012	4.0×4.0×1.2	SLW6045	6.0×6.0×4.5
SLW4018	4.0×4.0×1.8	SLW8040	8.0×8.0×4.0
SLW4020	4.0×4.0×2.0		

## ◆ Specification

Part Number	Inductance @100KHz,1V ( $\mu$ H)	DC Resistance( $\Omega$ )		Saturation Current(A)		Heat Rating Current (A)
		Max.	Typ.	Min.	Typ.	Typ.
		DCR		Isat		Irms
<b>SLW252010S Series</b>						
SLW252010SR47NST	0.47 $\pm$ 30%	0.054	0.047	2.50	3.35	2.75
SLW252010SR68NST	0.68 $\pm$ 30%	0.072	0.061	2.20	2.75	2.20
SLW252010S1R0MST	1.0 $\pm$ 20%	0.110	0.088	1.85	2.2	1.80
SLW252010S1R5MST	1.5 $\pm$ 20%	0.174	0.149	1.80	2.10	1.45
SLW252010S2R2MST	2.2 $\pm$ 20%	0.199	0.171	1.30	1.65	1.20
SLW252010S3R3MST	3.3 $\pm$ 20%	0.312	0.267	1.05	1.30	1.00
SLW252010S4R7MST	4.7 $\pm$ 20%	0.536	0.460	0.95	1.15	0.80
SLW252010S6R8MST	6.8 $\pm$ 20%	0.854	0.732	0.78	0.92	0.72
SLW252010S100MST	10 $\pm$ 20%	1.050	0.891	0.65	0.78	0.58
<b>SLW252012S Series</b>						
SLW252012SR47NST	0.47 $\pm$ 30%	0.045	0.041	3.60	4.03	2.27
SLW252012SR68NST	0.68 $\pm$ 30%	0.079	0.072	3.06	3.43	1.73
SLW252012S1R0MST	1.0 $\pm$ 20%	0.092	0.083	2.68	3.00	1.58
SLW252012S1R2MST	1.2 $\pm$ 20%	0.107	0.097	2.38	2.67	1.46
SLW252012S1R5MST	1.5 $\pm$ 20%	0.122	0.110	2.24	2.51	1.40
SLW252012S2R2MST	2.2 $\pm$ 20%	0.158	0.130	1.85	2.10	1.15
SLW252012S2R7MST	2.7 $\pm$ 20%	0.199	0.181	1.71	1.92	1.09
SLW252012S3R3MST	3.3 $\pm$ 20%	0.216	0.196	1.61	1.80	1.04
SLW252012S3R6MST	3.6 $\pm$ 20%	0.289	0.263	1.48	1.66	0.90
SLW252012S4R3MST	4.3 $\pm$ 20%	0.314	0.284	1.37	1.53	0.87
SLW252012S4R7MST	4.7 $\pm$ 20%	0.341	0.299	1.18	1.32	0.84
SLW252012S5R1MST	5.1 $\pm$ 20%	0.340	0.309	1.18	1.32	0.84
SLW252012S5R6MST	5.6 $\pm$ 20%	0.361	0.327	1.13	1.26	0.81
SLW252012S6R2MST	6.2 $\pm$ 20%	0.450	0.409	1.03	1.16	0.73
SLW252012S6R8MST	6.8 $\pm$ 20%	0.482	0.438	0.98	1.09	0.69
SLW252012S7R5MST	7.5 $\pm$ 20%	0.507	0.460	0.97	1.09	0.68
SLW252012S8R2MST	8.2 $\pm$ 20%	0.546	0.495	0.98	1.10	0.65
SLW252012S9R1MST	9.1 $\pm$ 20%	0.600	0.540	0.95	1.06	0.62
SLW252012S100MST	10 $\pm$ 20%	0.621	0.564	0.88	0.97	0.62
SLW252012S120MST	12 $\pm$ 20%	0.892	0.810	0.78	0.87	0.51
SLW252012S150MST	15 $\pm$ 20%	1.320	1.200	0.68	0.76	0.42
SLW252012S220MST	22 $\pm$ 20%	1.640	1.480	0.53	0.59	0.38

## ◆ Specification

Part Number	Inductance @100KHz, 1V (μH)	DC Resistance ±30% (Ω)	Min.Self-resonant Frequency (MHz)	Saturation Current(A)	Heat Rating Current (A)
		DCR	S.R.F	Isat	Irms
<b>SLW3010S Series</b>					
SLW3010S1R0NST	1.0±30%	0.062	180	1.51	1.45
SLW3010S1R5MST	1.5±20%	0.076	120	1.37	1.30
SLW3010S2R2MST	2.2±20%	0.105	100	1.24	1.09
SLW3010S2R7MST	2.7±20%	0.124	90	1.08	1.02
SLW3010S3R3MST	3.3±20%	0.138	74	1.05	0.96
SLW3010S3R6MST	3.6±20%	0.157	67	1.03	0.90
SLW3010S4R7MST	4.7±20%	0.214	59	0.82	0.77
SLW3010S6R8MST	6.8±20%	0.290	42	0.71	0.66
SLW3010S100MST	10±20%	0.380	39	0.62	0.58
SLW3010S120MST	12±20%	0.480	36	0.55	0.52
SLW3010S150MST	15±20%	0.580	30	0.49	0.47
SLW3010S220MST	22±20%	0.884	28	0.38	0.38
SLW3010S270MST	27±20%	1.026	25	0.32	0.35
SLW3010S330MST	33±20%	1.473	18	0.31	0.30
SLW3010S390MST	39±20%	1.663	18	0.30	0.28
SLW3010S430MST	43±20%	1.710	18	0.25	0.27
SLW3010S470MST	47±20%	1.853	18	0.24	0.26
SLW3010S510MST	51±20%	2.090	18	0.23	0.25
SLW3010S560MST	56±20%	2.204	16	0.23	0.24
<b>SLW3012S Series</b>					
SLW3012SR82NST	0.82±30%	0.030	180	2.15	2.47
SLW3012S1R0NST	1.0±30%	0.040	120	1.96	2.20
SLW3012S1R2MST	1.2±20%	0.045	120	2.33	2.01
SLW3012S1R5MST	1.5±20%	0.045	110	1.70	2.01
SLW3012S1R8MST	1.8±20%	0.055	90	1.59	1.84
SLW3012S2R2MST	2.2±20%	0.075	84	1.26	1.55
SLW3012S2R4MST	2.4±20%	0.068	100	1.21	1.50
SLW3012S2R7MST	2.7±20%	0.085	65	1.20	1.48
SLW3012S3R3MST	3.3±20%	0.100	64	1.10	1.36
SLW3012S4R7MST	4.7±20%	0.120	61	0.95	1.24
SLW3012S6R8MST	6.8±20%	0.190	61	0.79	0.98
SLW3012S100MST	10±20%	0.265	42	0.63	0.83
SLW3012S120MST	12±20%	0.345	32	0.50	0.73
SLW3012S150MST	15±20%	0.360	27	0.47	0.71
SLW3012S180MST	18±20%	0.545	25	0.45	0.58

## ◆ Specification

Part Number	Inductance @100KHz,1V ( $\mu$ H)	DC Resistance $\pm 30\%$ ( $\Omega$ )	Min.Self-resonant Frequency (MHz)	Saturation Current(A)	Heat Rating Current (A)
		DCR	S.R.F	Isat	Irms
<b>SLW3012S Series</b>					
SLW3012S220MST	22 $\pm$ 20%	0.645	23	0.44	0.53
SLW3012S270MST	27 $\pm$ 20%	0.770	21	0.42	0.49
SLW3012S330MST	33 $\pm$ 20%	0.875	18	0.38	0.46
SLW3012S360MST	36 $\pm$ 20%	0.950	18	0.36	0.44
SLW3012S390MST	39 $\pm$ 20%	1.330	18	0.32	0.37
SLW3012S470MST	47 $\pm$ 20%	1.380	14	0.28	0.36
SLW3012S560MST	56 $\pm$ 20%	1.380	14	0.27	0.36
SLW3012S620MST	62 $\pm$ 20%	1.530	12	0.26	0.35
SLW3012S680MST	68 $\pm$ 20%	1.670	12	0.25	0.33
SLW3012S820MST	82 $\pm$ 20%	2.540	12	0.23	0.27
SLW3012S101MST	100 $\pm$ 20%	2.860	12	0.22	0.25
<b>SLW3015S Series</b>					
SLW3015S1R0NST	1.0 $\pm$ 30%	0.037	150	2.44	2.10
SLW3015S1R2MST	1.5 $\pm$ 20%	0.040	110	2.34	1.95
SLW3015S1R5MST	1.2 $\pm$ 20%	0.050	100	2.44	1.70
SLW3015S1R8MST	1.8 $\pm$ 20%	0.050	92	1.86	1.70
SLW3015S2R2MST	2.2 $\pm$ 20%	0.060	86	1.70	1.60
SLW3015S2R7MST	2.7 $\pm$ 20%	0.075	64	1.61	1.43
SLW3015S3R3MST	3.3 $\pm$ 20%	0.080	68	1.45	1.36
SLW3015S3R6MST	3.6 $\pm$ 20%	0.105	59	1.36	1.20
SLW3015S4R3MST	4.3 $\pm$ 20%	0.115	53	1.27	1.14
SLW3015S4R7MST	4.7 $\pm$ 20%	0.125	46	1.17	1.09
SLW3015S5R1MST	5.1 $\pm$ 20%	0.125	49	1.14	1.09
SLW3015S6R2MST	6.2 $\pm$ 20%	0.195	46	1.06	0.86
SLW3015S6R8MST	6.8 $\pm$ 20%	0.200	39	0.92	0.85
SLW3015S100MST	10 $\pm$ 20%	0.250	41	0.87	0.77
SLW3015S120MST	12 $\pm$ 20%	0.320	32	0.74	0.68
SLW3015S150MST	15 $\pm$ 20%	0.350	30	0.70	0.65
SLW3015S180MST	18 $\pm$ 20%	0.430	23	0.59	0.59
SLW3015S220MST	22 $\pm$ 20%	0.460	23	0.55	0.57
SLW3015S330MST	33 $\pm$ 20%	0.820	20	0.47	0.43
SLW3015S390MST	39 $\pm$ 20%	0.995	14	0.43	0.39
SLW3015S430MST	43 $\pm$ 20%	1.060	16	0.39	0.37
SLW3015S470MST	47 $\pm$ 20%	1.250	14	0.37	0.35
SLW3015S560MST	56 $\pm$ 20%	1.280	13	0.35	0.34

## ◆ Specification

Part Number	Inductance @100KHz,1V ( $\mu$ H)	DC Resistance $\pm 30\%$ ( $\Omega$ )	Min.Self-resonant Frequency (MHz)	Saturation Current(A)	Heat Rating Current (A)
		DCR	S.R.F	Isat	Irms
<b>SLW3015S Series</b>					
SLW3015S620MST	62 $\pm$ 20%	1.430	13	0.34	0.32
SLW3015S680MST	68 $\pm$ 20%	2.700	11	0.29	0.23
<b>SLW4012S Series</b>					
SLW4012SR82NST	0.82 $\pm$ 30%	0.050	150	3.53	1.65
SLW4012S1R0NST	1.0 $\pm$ 30%	0.050	120	2.61	1.65
SLW4012S1R5MST	1.5 $\pm$ 20%	0.065	90	2.10	1.46
SLW4012S1R8MST	1.8 $\pm$ 20%	0.080	88	2.47	1.32
SLW4012S2R2MST	2.2 $\pm$ 20%	0.080	74	1.76	1.32
SLW4012S2R7MST	2.7 $\pm$ 20%	0.090	71	1.90	1.25
SLW4012S3R3MST	3.3 $\pm$ 20%	0.113	60	1.25	1.12
SLW4012S3R6MST	3.6 $\pm$ 20%	0.110	57	1.20	1.12
SLW4012S4R3MST	4.3 $\pm$ 20%	0.140	54	1.75	1.00
SLW4012S4R7MST	4.7 $\pm$ 20%	0.125	50	1.15	1.05
SLW4012S5R1MST	5.1 $\pm$ 20%	0.155	50	1.21	0.95
SLW4012S6R8MST	6.8 $\pm$ 20%	0.198	40	0.95	0.84
SLW4012S100MST	10 $\pm$ 20%	0.265	33	0.80	0.77
SLW4012S120MST	12 $\pm$ 20%	0.290	32	0.66	0.70
SLW4012S150MST	15 $\pm$ 20%	0.340	25	0.56	0.64
SLW4012S180MST	18 $\pm$ 20%	0.470	23	0.55	0.55
SLW4012S220MST	22 $\pm$ 20%	0.470	20	0.54	0.55
SLW4012S270MST	27 $\pm$ 20%	0.720	18	0.50	0.45
SLW4012S330MST	33 $\pm$ 20%	0.810	17	0.42	0.42
SLW4012S360MST	36 $\pm$ 20%	0.900	14	0.40	0.40
SLW4012S390MST	39 $\pm$ 20%	1.100	16	0.55	0.37
SLW4012S470MST	47 $\pm$ 20%	1.100	12	0.35	0.37
SLW4012S560MST	56 $\pm$ 20%	1.250	11	0.33	0.33
SLW4012S680MST	68 $\pm$ 20%	1.460	11	0.30	0.31
SLW4012S820MST	82 $\pm$ 20%	2.140	11	0.28	0.26
SLW4012S101MST	100 $\pm$ 20%	2.210	9.4	0.25	0.25
<b>SLW4018S Series</b>					
SLW4018S1R0NST	1.0 $\pm$ 30%	0.025	80	4.80	2.00
SLW4018S2R2MST	2.2 $\pm$ 20%	0.045	52	2.70	1.65
SLW4018S3R3MST	3.3 $\pm$ 20%	0.070	44	2.45	1.23
SLW4018S4R7MST	4.7 $\pm$ 20%	0.090	34	1.70	1.20
SLW4018S6R8MST	6.8 $\pm$ 20%	0.110	29	1.45	1.06

## ◆ Specification

Part Number	Inductance @100KHz,1V ( $\mu$ H)	DC Resistance $\pm 30\%$ ( $\Omega$ )	Min.Self-resonant Frequency (MHz)	Saturation Current(A)	Heat Rating Current (A)
		DCR	S.R.F	Isat	Irms
<b>SLW4018S Series</b>					
SLW4018S100MST	10 $\pm$ 20%	0.180	24	1.30	0.84
SLW4018S150MST	15 $\pm$ 20%	0.250	19	0.94	0.65
SLW4018S220MST	22 $\pm$ 20%	0.360	16	0.80	0.59
SLW4018S330MST	33 $\pm$ 20%	0.530	12	0.65	0.49
SLW4018S470MST	47 $\pm$ 20%	0.650	10	0.57	0.42
SLW4018S680MST	68 $\pm$ 20%	1.000	8.3	0.47	0.32
SLW4018S101MST	100 $\pm$ 20%	1.750	6.5	0.40	0.25
SLW4018S151MST	150 $\pm$ 20%	2.500	5.5	0.31	0.22
SLW4018S221MST	220 $\pm$ 20%	4.000	4	0.27	0.17
<b>SLW4020S Series</b>					
SLW4020S1R0NST	1.0 $\pm$ 30%	0.029	75	4.85	2.15
SLW4020S1R2MST	1.2 $\pm$ 20%	0.029	72	5.10	2.15
SLW4020S1R5MST	1.5 $\pm$ 20%	0.035	71	4.45	1.98
SLW4020S2R2MST	2.2 $\pm$ 20%	0.040	49	3.40	1.85
SLW4020S3R3MST	3.3 $\pm$ 20%	0.070	44	3.20	1.40
SLW4020S3R6MST	3.6 $\pm$ 20%	0.055	49	2.80	1.54
SLW4020S4R7MST	4.7 $\pm$ 20%	0.075	42	2.35	1.34
SLW4020S5R1MST	5.1 $\pm$ 20%	0.085	42	2.30	1.27
SLW4020S5R6MST	5.6 $\pm$ 20%	0.090	30	2.20	1.22
SLW4020S6R2MST	6.2 $\pm$ 20%	0.115	36	2.15	1.08
SLW4020S6R8MST	6.8 $\pm$ 20%	0.125	33	2.20	1.04
SLW4020S7R5MST	7.5 $\pm$ 20%	0.115	30	1.85	1.08
SLW4020S8R2MST	8.2 $\pm$ 20%	0.125	27	1.75	1.04
SLW4020S100MST	10 $\pm$ 20%	0.165	26	1.60	0.90
SLW4020S120MST	12 $\pm$ 20%	0.175	26	1.50	0.88
SLW4020S150MST	15 $\pm$ 20%	0.230	24	1.35	0.77
SLW4020S220MST	22 $\pm$ 20%	0.350	15	1.05	0.62
SLW4020S270MST	27 $\pm$ 20%	0.545	14	1.02	0.50
SLW4020S330MST	33 $\pm$ 20%	0.550	11	0.85	0.49
SLW4020S390MST	39 $\pm$ 20%	0.650	11	0.82	0.46
SLW4020S430MST	43 $\pm$ 20%	0.660	10	0.77	0.45
SLW4020S470MST	47 $\pm$ 20%	0.710	10	0.74	0.44
SLW4020S510MST	51 $\pm$ 20%	0.750	10	0.70	0.42
SLW4020S560MST	56 $\pm$ 20%	0.800	10	0.66	0.41
SLW4020S620MST	62 $\pm$ 20%	0.900	9.6	0.65	0.39

## ◆ Specification

Part Number	Inductance @100KHz,1V ( $\mu$ H)	DC Resistance $\pm 30\%$ ( $\Omega$ )	Min.Self-resonant Frequency (MHz)	Saturation Current(A)	Heat Rating Current (A)
		DCR	S.R.F	Isat	Irms
<b>SLW4020S Series</b>					
SLW4020S680MST	68 $\pm$ 20%	1.060	7.7	0.61	0.36
SLW4020S750MST	75 $\pm$ 20%	1.120	7.7	0.60	0.35
SLW4020S820MST	82 $\pm$ 20%	1.170	7.2	0.56	0.34
SLW4020S101MST	100 $\pm$ 20%	1.350	6.3	0.52	0.31
<b>SLW4030S Series</b>					
SLW4030SR91NST	0.91 $\pm$ 30%	0.022	100	6.25	3.15
SLW4030S1R2MST	1.2 $\pm$ 20%	0.025	80	5.80	2.96
SLW4030S1R5MST	1.5 $\pm$ 20%	0.030	62	4.84	2.92
SLW4030S1R8MST	1.8 $\pm$ 20%	0.030	60	5.40	2.92
SLW4030S2R2MST	2.2 $\pm$ 20%	0.035	52	4.90	2.57
SLW4030S3R3MST	3.3 $\pm$ 20%	0.040	38	3.30	2.40
SLW4030S4R3MST	4.3 $\pm$ 20%	0.055	37	2.95	2.10
SLW4030S4R7MST	4.7 $\pm$ 20%	0.060	31	2.90	2.00
SLW4030S5R6MST	5.6 $\pm$ 20%	0.065	30	2.60	1.95
SLW4030S6R2MST	6.2 $\pm$ 20%	0.070	29	2.50	1.85
SLW4030S6R8MST	6.8 $\pm$ 20%	0.090	24	2.75	1.60
SLW4030S7R5MST	7.5 $\pm$ 20%	0.085	26	2.20	1.65
SLW4030S8R2MST	8.2 $\pm$ 20%	0.090	26	2.10	1.60
SLW4030S9R1MST	9.1 $\pm$ 20%	0.095	23	2.00	1.55
SLW4030S100MST	10 $\pm$ 20%	0.100	21	1.95	1.50
SLW4030S120MST	12 $\pm$ 20%	0.135	18	1.70	1.30
SLW4030S150MST	15 $\pm$ 20%	0.190	16	1.65	1.11
SLW4030S180MST	18 $\pm$ 20%	0.200	10	1.40	1.10
SLW4030S220MST	22 $\pm$ 20%	0.225	10	1.30	1.00
SLW4030S330MST	33 $\pm$ 20%	0.330	10	1.10	0.84
SLW4030S360MST	36 $\pm$ 20%	0.335	9.8	1.05	0.83
SLW4030S390MST	39 $\pm$ 20%	0.435	10	1.03	0.73
SLW4030S430MST	43 $\pm$ 20%	0.440	9.2	1.00	0.73
SLW4030S470MST	47 $\pm$ 20%	0.445	8.4	0.95	0.72
SLW4030S510MST	51 $\pm$ 20%	0.470	8.4	0.90	0.70
SLW4030S560MST	56 $\pm$ 20%	0.555	8.4	0.85	0.65
SLW4030S620MST	62 $\pm$ 20%	0.829	7	0.80	0.53
SLW4030S680MST	68 $\pm$ 20%	0.868	7	0.75	0.52
SLW4030S750MST	75 $\pm$ 20%	1.020	6.3	0.70	0.48
SLW4030S820MST	82 $\pm$ 20%	1.060	5.6	0.66	0.47



## ◆ Specification

Part Number	Inductance @100KHz,1V ( $\mu$ H)	DC Resistance $\pm 30\%$ ( $\Omega$ )	Min.Self-resonant Frequency (MHz)	Saturation Current(A)	Heat Rating Current (A)
		DCR	S.R.F	Isat	Irms
<b>SLW4030S Series</b>					
SLW4030S910MST	91 $\pm 20\%$	1.100	5.6	0.65	0.46
SLW4030S101MST	100 $\pm 20\%$	1.150	5.6	0.60	0.45
SLW4030S121MST	120 $\pm 20\%$	1.350	5.4	0.55	0.42
<b>SLW5020S Series</b>					
SLW5020S1R0NST	1.0 $\pm 30\%$	0.018	97	4.33	3.70
SLW5020S1R5MST	1.5 $\pm 20\%$	0.026	80	3.85	3.20
SLW5020S2R2MST	2.2 $\pm 20\%$	0.035	61	3.85	2.90
SLW5020S3R3MST	3.3 $\pm 20\%$	0.044	46	3.25	2.40
SLW5020S4R7MST	4.7 $\pm 20\%$	0.059	33	2.40	2.05
SLW5020S6R8MST	6.8 $\pm 20\%$	0.087	30	1.80	1.70
SLW5020S100MST	10 $\pm 20\%$	0.110	24	1.79	1.50
SLW5020S150MST	15 $\pm 20\%$	0.165	20	1.44	1.25
SLW5020S220MST	22 $\pm 20\%$	0.235	16	1.18	1.05
SLW5020S330MST	33 $\pm 20\%$	0.370	13	0.97	0.83
SLW5020S470MST	47 $\pm 20\%$	0.525	11	0.81	0.70
SLW5020S680MST	68 $\pm 20\%$	0.885	8.8	0.70	0.53
SLW5020S101MST	100 $\pm 20\%$	1.060	7.6	0.57	0.49
<b>SLW5040S Series</b>					
SLW5040S1R5MST	1.5 $\pm 20\%$	0.013	60	7.30	4.45
SLW5040S2R2MST	2.2 $\pm 20\%$	0.017	42	6.50	3.95
SLW5040S3R3MST	3.3 $\pm 20\%$	0.025	32	5.10	3.40
SLW5040S4R7MST	4.7 $\pm 20\%$	0.029	28	4.40	3.10
SLW5040S6R8MST	6.8 $\pm 20\%$	0.043	21	3.80	2.40
SLW5040S100MST	10 $\pm 20\%$	0.055	18	2.90	2.10
SLW5040S150MST	15 $\pm 20\%$	0.089	13	2.30	1.60
SLW5040S220MST	22 $\pm 20\%$	0.126	9	1.90	1.40
SLW5040S330MST	33 $\pm 20\%$	0.192	7	1.60	1.20
SLW5040S470MST	47 $\pm 20\%$	0.283	6	1.30	0.94
<b>SLW6020S Series</b>					
SLW6020SR50NST	0.50 $\pm 30\%$	0.013	130	4.90	4.05
SLW6020SR68NST	0.68 $\pm 30\%$	0.017	120	7.50	3.80
SLW6020SR82NST	0.82 $\pm 30\%$	0.017	110	6.60	3.80
SLW6020S1R0NST	1.0 $\pm 30\%$	0.020	94	4.15	3.25
SLW6020S1R2MST	1.2 $\pm 20\%$	0.022	88	5.90	3.20
SLW6020S1R5MST	1.5 $\pm 20\%$	0.022	79	4.25	3.20

## ◆ Specification

Part Number	Inductance @100KHz,1V ( $\mu$ H)	DC Resistance $\pm 30\%$ ( $\Omega$ )	Min.Self-resonant Frequency (MHz)	Saturation Current(A)	Heat Rating Current (A)
		DCR	S.R.F	Isat	Irms
<b>SLW6020S Series</b>					
SLW6020S1R8MST	1.8 $\pm 20\%$	0.028	68	4.85	2.75
SLW6020S2R0MST	2.0 $\pm 20\%$	0.035	64	4.30	2.45
SLW6020S2R2MST	2.2 $\pm 20\%$	0.028	61	3.75	2.75
SLW6020S2R7MST	2.7 $\pm 20\%$	0.035	56	3.90	2.60
SLW6020S3R3MST	3.3 $\pm 20\%$	0.035	51	3.15	2.60
SLW6020S3R9MST	3.9 $\pm 20\%$	0.049	46	3.25	2.10
SLW6020S4R3MST	4.3 $\pm 20\%$	0.049	44	2.70	2.10
SLW6020S4R7MST	4.7 $\pm 20\%$	0.058	41	3.00	2.00
SLW6020S5R6MST	5.6 $\pm 20\%$	0.058	36	2.40	1.90
SLW6020S6R2MST	6.2 $\pm 20\%$	0.079	35	2.30	1.80
SLW6020S6R8MST	6.8 $\pm 20\%$	0.079	31	2.20	1.80
SLW6020S8R2MST	8.2 $\pm 20\%$	0.105	28	2.10	1.40
SLW6020S100MST	10 $\pm 20\%$	0.105	27	1.75	1.40
SLW6020S120MST	12 $\pm 20\%$	0.120	23	1.70	1.35
SLW6020S150MST	15 $\pm 20\%$	0.145	21	1.50	1.20
SLW6020S180MST	18 $\pm 20\%$	0.175	19	1.23	1.10
SLW6020S220MST	22 $\pm 20\%$	0.204	16	1.25	1.00
<b>SLW6028S Series</b>					
SLW6028S1R5MST	1.5 $\pm 20\%$	0.013	65	6.00	4.58
SLW6028S2R2MST	2.2 $\pm 20\%$	0.015	56	5.10	4.09
SLW6028S2R7MST	2.7 $\pm 20\%$	0.020	48	3.80	3.75
SLW6028S3R3MST	3.3 $\pm 20\%$	0.025	41	3.63	3.48
SLW6028S4R7MST	4.7 $\pm 20\%$	0.030	35	3.00	3.08
SLW6028S5R1MST	5.1 $\pm 20\%$	0.035	33	3.55	2.89
SLW6028S6R2MST	6.2 $\pm 20\%$	0.040	30	3.05	2.58
SLW6028S6R8MST	6.8 $\pm 20\%$	0.047	27	2.85	2.40
SLW6028S8R2MST	8.2 $\pm 20\%$	0.055	24	2.60	2.25
SLW6028S9R1MST	9.1 $\pm 20\%$	0.060	24	2.55	2.15
SLW6028S100MST	10 $\pm 20\%$	0.072	23	2.04	1.95
SLW6028S120MST	12 $\pm 20\%$	0.080	18	1.80	1.85
SLW6028S150MST	15 $\pm 20\%$	0.125	18	1.75	1.45
SLW6028S180MST	18 $\pm 20\%$	0.120	15	1.52	1.45
SLW6028S220MST	22 $\pm 20\%$	0.140	14	1.60	1.40
SLW6028S270MST	27 $\pm 20\%$	0.155	13	1.50	1.32

## ◆ Specification

Part Number	Inductance @100KHz,1V ( $\mu$ H)	DC Resistance $\pm 30\%$ ( $\Omega$ )	Min.Self-resonant Frequency (MHz)	Saturation Current(A)	Heat Rating Current (A)
		DCR	S.R.F	Isat	Irms
<b>SLW6028S Series</b>					
SLW6028S330MST	33 $\pm 20\%$	0.185	12	1.35	1.22
SLW6028S360MST	36 $\pm 20\%$	0.215	11	1.25	1.13
SLW6028S390MST	39 $\pm 20\%$	0.225	11	1.25	1.10
SLW6028S430MST	43 $\pm 20\%$	0.235	11	1.20	1.07
SLW6028S470MST	47 $\pm 20\%$	0.245	9.5	1.15	1.06
SLW6028S510MST	51 $\pm 20\%$	0.265	9.5	1.05	1.01
SLW6028S620MST	62 $\pm 20\%$	0.345	7.7	0.95	0.89
SLW6028S680MST	68 $\pm 20\%$	0.360	7.7	0.95	0.86
SLW6028S750MST	75 $\pm 20\%$	0.410	7.7	0.90	0.81
SLW6028S820MST	82 $\pm 20\%$	0.445	7.7	0.90	0.78
<b>SLW6045S Series</b>					
SLW6045SR82NST	0.82 $\pm 30\%$	0.008	140	10.40	5.90
SLW6045S1R0NST	1.0 $\pm 30\%$	0.011	100	9.85	5.14
SLW6045S1R2MST	1.2 $\pm 20\%$	0.010	100	8.35	5.40
SLW6045S1R5MST	1.5 $\pm 20\%$	0.012	65	8.80	4.95
SLW6045S1R8MST	1.8 $\pm 20\%$	0.012	74	7.60	4.95
SLW6045S2R2MST	2.2 $\pm 20\%$	0.014	52	6.75	4.60
SLW6045S2R3MST	2.3 $\pm 20\%$	0.021	60	6.00	3.50
SLW6045S2R7MST	2.7 $\pm 20\%$	0.015	38	5.75	4.30
SLW6045S3R0MST	3.0 $\pm 20\%$	0.020	35	5.60	3.80
SLW6045S3R3MST	3.3 $\pm 20\%$	0.021	32	5.90	3.70
SLW6045S3R6MST	3.6 $\pm 20\%$	0.021	28	5.25	3.70
SLW6045S4R3MST	4.3 $\pm 20\%$	0.023	23	4.45	3.50
SLW6045S4R7MST	4.7 $\pm 20\%$	0.026	24	4.97	3.30
SLW6045S5R1MST	5.1 $\pm 20\%$	0.026	23	4.40	3.30
SLW6045S5R6MST	5.6 $\pm 20\%$	0.029	23	4.15	3.15
SLW6045S6R2MST	6.2 $\pm 20\%$	0.031	26	4.43	3.00
SLW6045S6R8MST	6.8 $\pm 20\%$	0.031	20	3.90	3.00
SLW6045S7R5MST	7.5 $\pm 20\%$	0.034	18	3.50	2.90
SLW6045S8R2MST	8.2 $\pm 20\%$	0.043	21	3.90	2.60
SLW6045S9R1MST	9.1 $\pm 20\%$	0.043	17	3.35	2.60
SLW6045S100MST	10 $\pm 20\%$	0.048	15	3.20	2.45
SLW6045S120MST	12 $\pm 20\%$	0.058	13	2.80	2.20
SLW6045S150MST	15 $\pm 20\%$	0.068	12	2.50	2.05

## ◆ Specification

Part Number	Inductance @100KHz,1V ( $\mu$ H)	DC Resistance $\pm 30\%$ ( $\Omega$ )	Min.Self-resonant Frequency (MHz)	Saturation Current(A)	Heat Rating Current (A)
		DCR	S.R.F	Isat	Irms
<b>SLW6045S Series</b>					
SLW6045S180MST	18 $\pm$ 20%	0.081	10	2.20	1.85
SLW6045S220MST	22 $\pm$ 20%	0.089	10	2.05	1.80
SLW6045S270MST	27 $\pm$ 20%	0.102	9.2	1.90	1.65
SLW6045S300MST	30 $\pm$ 20%	0.132	7.8	1.70	1.50
SLW6045S330MST	33 $\pm$ 20%	0.137	7.8	1.65	1.45
SLW6045S360MST	36 $\pm$ 20%	0.173	7.8	1.62	1.40
SLW6045S390MST	39 $\pm$ 20%	0.180	7.8	1.50	1.25
SLW6045S430MST	43 $\pm$ 20%	0.200	7.7	1.63	1.20
SLW6045S470MST	47 $\pm$ 20%	0.200	6.4	1.40	1.20
SLW6045S510MST	51 $\pm$ 20%	0.207	6.4	1.35	1.15
SLW6045S560MST	56 $\pm$ 20%	0.221	6.4	1.30	1.10
SLW6045S620MST	62 $\pm$ 20%	0.235	6.4	1.25	1.10
SLW6045S680MST	68 $\pm$ 20%	0.289	6.4	1.20	1.00
SLW6045S750MST	75 $\pm$ 20%	0.305	5	1.15	0.95
SLW6045S820MST	82 $\pm$ 20%	0.341	4.9	1.05	0.90
SLW6045S910MST	91 $\pm$ 20%	0.359	4.9	1.00	0.85
SLW6045S101MST	100 $\pm$ 20%	0.433	4.2	0.95	0.80
SLW6045S121MST	120 $\pm$ 20%	0.484	4.2	0.85	0.77
SLW6045S151MST	150 $\pm$ 20%	0.580	4.2	0.80	0.70
SLW6045S221MST	220 $\pm$ 20%	0.834	3.5	0.70	0.59
SLW6045S331MST	330 $\pm$ 20%	1.270	2.8	0.57	0.57
<b>SLW8040S Series</b>					
SLW8040SR82NST	0.82 $\pm$ 30%	0.008	94	13.80	6.30
SLW8040S1R0NST	1.0 $\pm$ 30%	0.008	89	9.85	6.30
SLW8040S1R5MST	1.5 $\pm$ 20%	0.010	67	8.15	5.65
SLW8040S2R0MST	2.0 $\pm$ 20%	0.012	43	9.25	5.15
SLW8040S2R2MST	2.2 $\pm$ 20%	0.012	41	7.10	5.15
SLW8040S3R0MST	3.0 $\pm$ 20%	0.014	32	6.10	4.70
SLW8040S3R3MST	3.3 $\pm$ 20%	0.017	27	6.50	4.40
SLW8040S3R6MST	3.6 $\pm$ 20%	0.017	30	7.52	4.35
SLW8040S3R9MST	3.9 $\pm$ 20%	0.017	26	5.75	4.35
SLW8040S4R7MST	4.7 $\pm$ 20%	0.019	24	5.90	4.10
SLW8040S5R1MST	5.1 $\pm$ 20%	0.019	22	4.70	4.05

## ◆ Specification

Part Number	Inductance @100KHz,1V ( $\mu$ H)	DC Resistance $\pm 30\%$ ( $\Omega$ )	Min.Self-resonant Frequency (MHz)	Saturation Current(A)	Heat Rating Current (A)
		DCR	S.R.F	Isat	Irms
<b>SLW8040S Series</b>					
SLW8040S5R6MST	5.6 $\pm$ 20%	0.021	24	6.00	3.85
SLW8040S6R2MST	6.2 $\pm$ 20%	0.021	20	4.45	3.85
SLW8040S6R8MST	6.8 $\pm$ 20%	0.024	20	4.55	3.60
SLW8040S8R2MST	8.2 $\pm$ 20%	0.026	17	4.20	3.45
SLW8040S100MST	10 $\pm$ 20%	0.029	15	3.60	3.30
SLW8040S150MST	15 $\pm$ 20%	0.047	12	2.95	2.60
SLW8040S180MST	18 $\pm$ 20%	0.053	11	2.70	2.40
SLW8040S220MST	22 $\pm$ 20%	0.069	9.5	2.40	2.10
SLW8040S270MST	27 $\pm$ 20%	0.078	9.2	2.15	2.00
SLW8040S330MST	33 $\pm$ 20%	0.097	7.8	2.05	1.80
SLW8040S360MST	36 $\pm$ 20%	0.102	7.8	2.00	1.75
SLW8040S390MST	39 $\pm$ 20%	0.107	7.8	1.95	1.70
SLW8040S430MST	43 $\pm$ 20%	0.113	7.8	1.90	1.65
SLW8040S470MST	47 $\pm$ 20%	0.136	6.4	1.75	1.55
SLW8040S510MST	51 $\pm$ 20%	0.142	6.4	1.70	1.50
SLW8040S560MST	56 $\pm$ 20%	0.148	6.4	1.55	1.45
SLW8040S620MST	62 $\pm$ 20%	0.182	6.4	1.50	1.30
SLW8040S680MST	68 $\pm$ 20%	0.196	4.9	1.45	1.25
SLW8040S750MST	75 $\pm$ 20%	0.211	4.9	1.35	1.20
SLW8040S820MST	82 $\pm$ 20%	0.225	5.9	1.30	1.15
SLW8040S910MST	91 $\pm$ 20%	0.272	4.9	1.20	1.05
SLW8040S101MST	100 $\pm$ 20%	0.290	4.2	1.15	1.00
SLW8040S121MST	120 $\pm$ 20%	0.334	3.5	1.05	0.95
SLW8040S151MST	150 $\pm$ 20%	0.410	3.5	1.10	0.85
SLW8040S221MST	220 $\pm$ 20%	0.599	3.5	0.85	0.80
SLW8040S331MST	330 $\pm$ 20%	0.889	2.8	0.68	0.64

## ◆ Note

- 1: All test data is referenced to 20°C ambient;
- 2: Rated current: Isat or Irms, whichever is smaller;
- 3: Isat: DC current at which the inductance drops approximate 30% from its value without current;
- 4: Irms: DC current that causes the temperature rise ( $\Delta T = 40^\circ\text{C}$ ) from 20°C ambient.

◆ **TYPICAL ELECTRICAL CHARACTERISTICS**

### SLW252010S Series

Temperature vs. DC Current Characteristics



Inductance vs. DC Current Characteristics



### SLW252012S Series

Temperature vs. DC Current Characteristics



Inductance vs. DC Current Characteristics

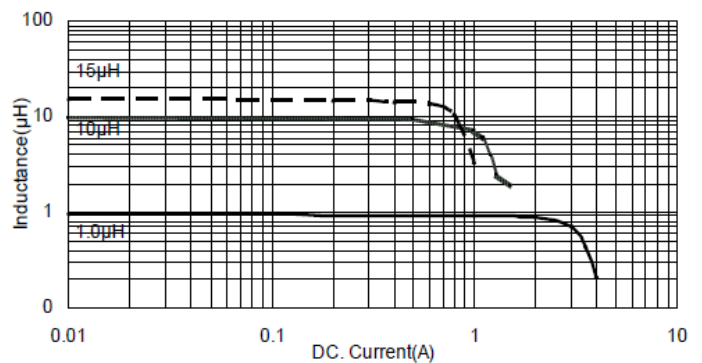

### SLW3010S Series

Temperature vs. DC Current Characteristics



Inductance vs. DC Current Characteristics



## ◆ TYPICAL ELECTRICAL CHARACTERISTICS

### SLW3012S Series

Temperature vs. DC Current Characteristics



Inductance vs. DC Current Characteristics



### SLW3015S Series

Temperature vs. DC Current Characteristics



Inductance vs. DC Current Characteristics

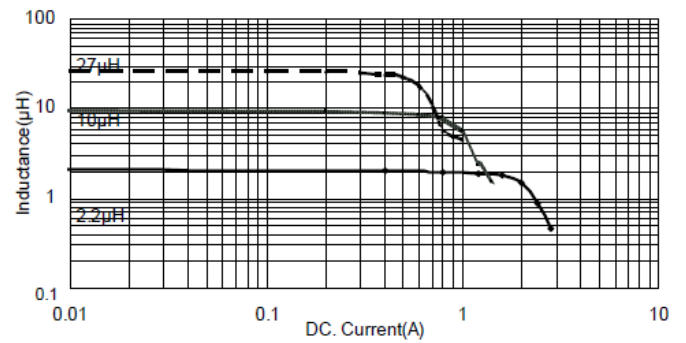

### SLW4012S Series

Temperature vs. DC Current Characteristics



Inductance vs. DC Current Characteristic



◆ **TYPICAL ELECTRICAL CHARACTERISTICS**

### SLW4018S Series

Temperature vs. DC Current Characteristics



Inductance vs. DC Current Characteristics



### SLW4020S Series

Temperature vs. DC Current Characteristics



Inductance vs. DC Current Characteristics

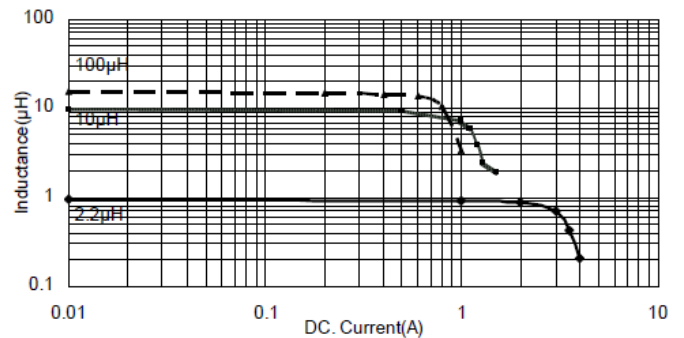

### SLW4030S Series

Temperature vs. DC Current Characteristics

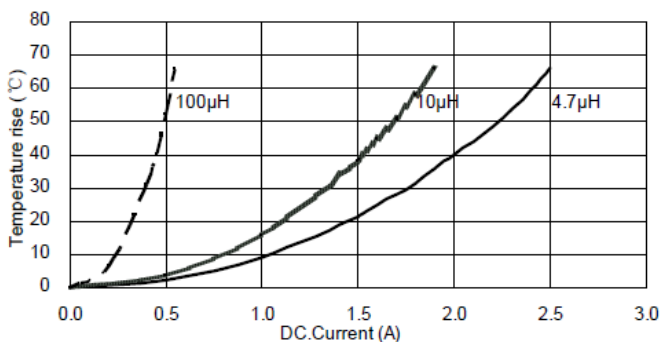

Inductance vs. DC Current Characteristics

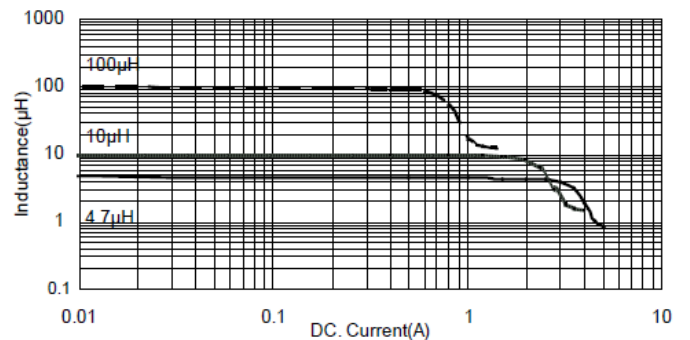



## ◆ TYPICAL ELECTRICAL CHARACTERISTICS

### SLW5020S Series

Temperature vs. DC Current Characteristics

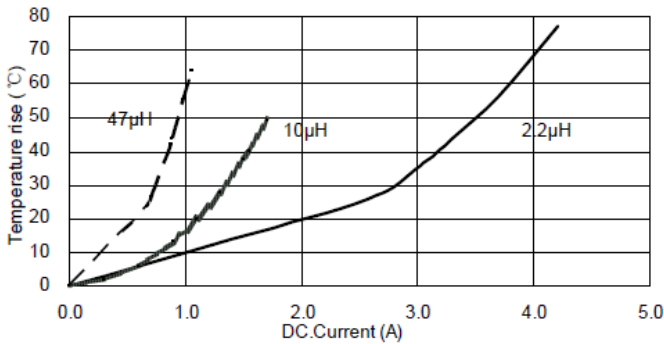

Inductance vs. DC Current Characteristics

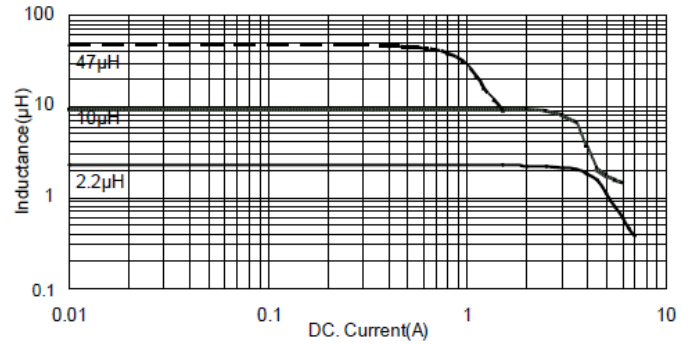

### SLW5040S Series

Temperature vs. DC Current Characteristics

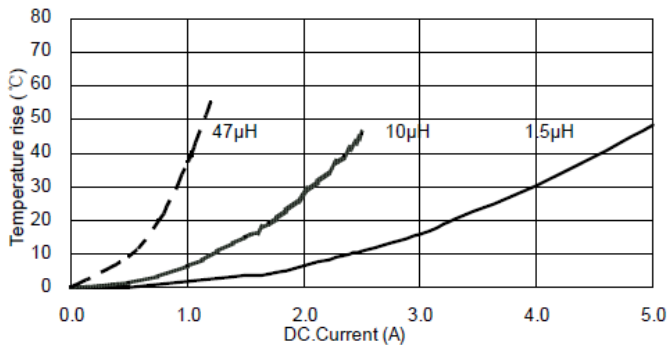

Inductance vs. DC Current Characteristics

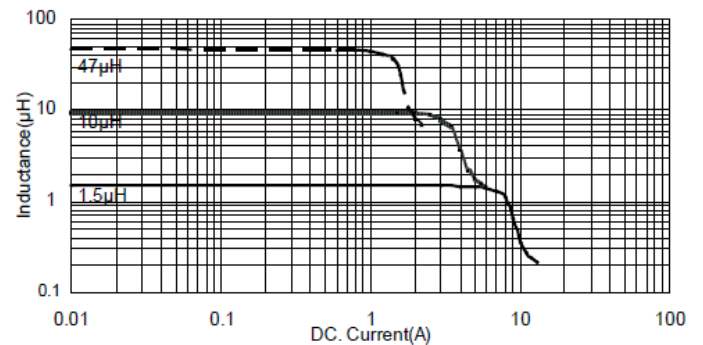

### SLW6020S Series

Temperature vs. DC Current Characteristics

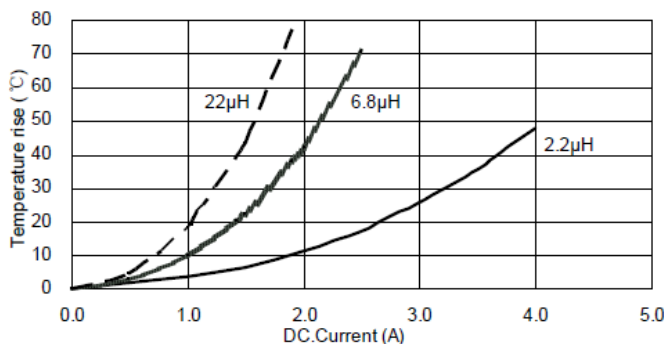

Inductance vs. DC Current Characteristics

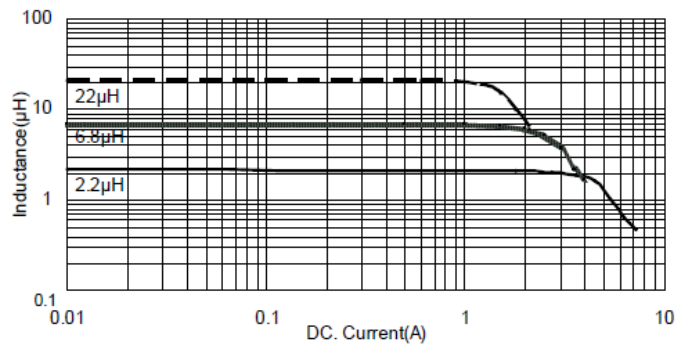

## ◆ TYPICAL ELECTRICAL CHARACTERISTICS

### SLW6028S Series

Temperature vs. DC Current Characteristics



Inductance vs. DC Current Characteristics

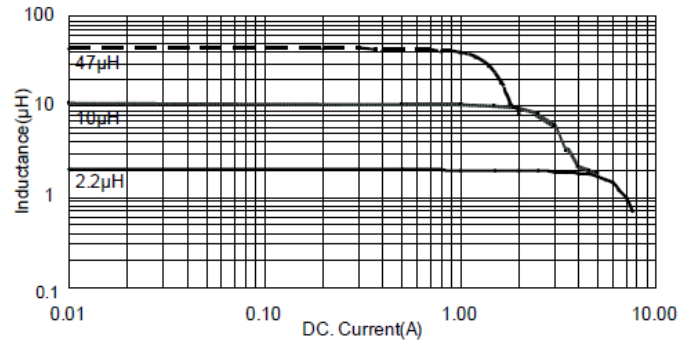

### SLW6045S Series

Temperature vs. DC Current Characteristics



Inductance vs. DC Current Characteristics

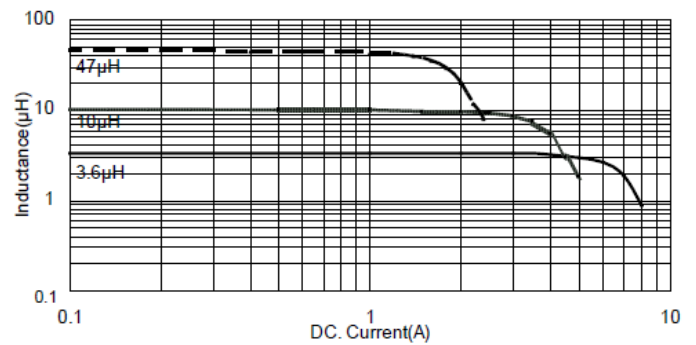

### SLW8040S Series

Temperature vs. DC Current Characteristics



Inductance vs. DC Current Characteristics

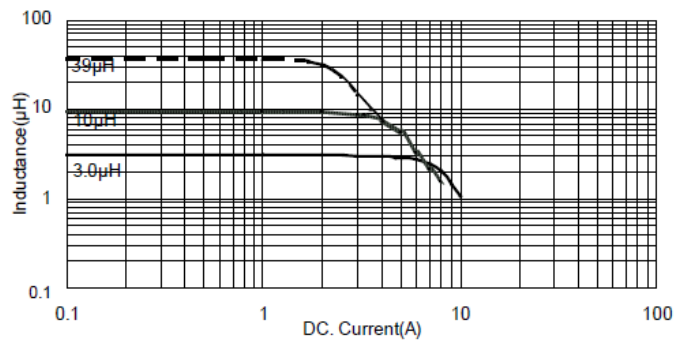

◆ **Package**

Size EIA (EIA)	SLW2520S	SLW3010S	SLW3012S	SLW3015S	SLW4012S	SLW4018S	SLW4020S
Standard Packing Quantity (pcs / reel)	2,000	2,000	2,000	2,000	4,500	3,000	3,000
	SLW4030S	SLW5020S	SLW5040S	SLW6020S	SLW6028S	SLW6045S	SLW8040S
	2,000	2,500	1,500	2,500	2,000	1,500	1,000

## X-ON Electronics

Largest Supplier of Electrical and Electronic Components

*Click to view similar products for [Fixed Inductors](#) category:*

*Click to view products by [Sunltech](#) manufacturer:*

Other Similar products are found below :

[CR32NP-100KC](#) [CR32NP-151KC](#) [CR32NP-180KC](#) [CR32NP-181KC](#) [CR32NP-1R5MC](#) [CR32NP-390KC](#) [CR32NP-3R9MC](#) [CR32NP-680KC](#) [CR32NP-820KC](#) [CR32NP-8R2MC](#) [CR43NP-390KC](#) [CR43NP-560KC](#) [CR43NP-680KC](#) [CR54NP-181KC](#) [CR54NP-470LC](#) [CR54NP-820KC](#) [CR54NP-8R5MC](#) [70F224AI](#) [MGDQ4-00004-P](#) [MHL1ECTTP18NJ](#) [MHQ1005P10NJ](#) [MHQ1005P1N0S](#) [MHQ1005P2N4S](#) [MHQ1005P3N6S](#) [MHQ1005P5N1S](#) [MHQ1005P8N2J](#) [PE-51506NL](#) [PE-53601NL](#) [PE-53602NL](#) [PE-53630NL](#) [PE-53824SNLT](#) [PE-92100NL](#) [PG0434.801NLT](#) [PG0936.113NLT](#) [9220-20](#) [9310-16](#) [PM06-2N7](#) [PM06-39NJ](#) [A01TK](#) [1206CS-471XJ](#) [HC2LP-R47-R](#) [HC2-R47-R](#) [HC3-2R2-R](#) [HCF1305-3R3-R](#) [1206CS-151XG](#) [RCH664NP-140L](#) [RCH664NP-4R7M](#) [RCH8011NP-221L](#) [RCP1317NP-332L](#) [RCP1317NP-391L](#)