

Wire Wound SMD Power Inductor



◆ Features

- 1、Magnetic-resin shielded construction reduces buzz noise to ultra-low levels;
- 2、Metallization on ferrite core results in excellent shock resistance and damage-free durability;
- 3、Closed magnetic circuit design reduces leakage flux and Electro Magnetic Interference (EMI);
- 4、30% higher current rating than conventional inductors of equal size;
- 5、Take up less PCB real estate and save more power.



◆ Applications

- 1、LED Lighting;
- 2、Mobile devices with multifunction such as adding color TV and camera;
- 3、Flat-screen TVs, blue-ray disc recorders, set top boxes;
- 4、Notebooks, desktop computers, servers, graphic cards;
- 5、Portable gaming devices, personal navigation systems, personal multimedia devices;
- 6、Automotive systems
- 7、Telecomm base stations

◆ Lead Free Part Numbering

SLW 4020 S 100 M S T
(1) (2) (3) (4) (5) (6) (7)

- (1) Series Type
- (2) Dimension: L X H
- (3) Material Code
- (4) Inductance: 2R2=2.2 μ H ;
100=10 μ H; 101=100 μ H
- (5) Inductance Tolerance: M=±20%, N=±30%
- (6) Company Code
- (7) Packaging : Tape Carrier Package

◆ Dimensions

SLW 252010/252012 Series

Recommended Land Pattern

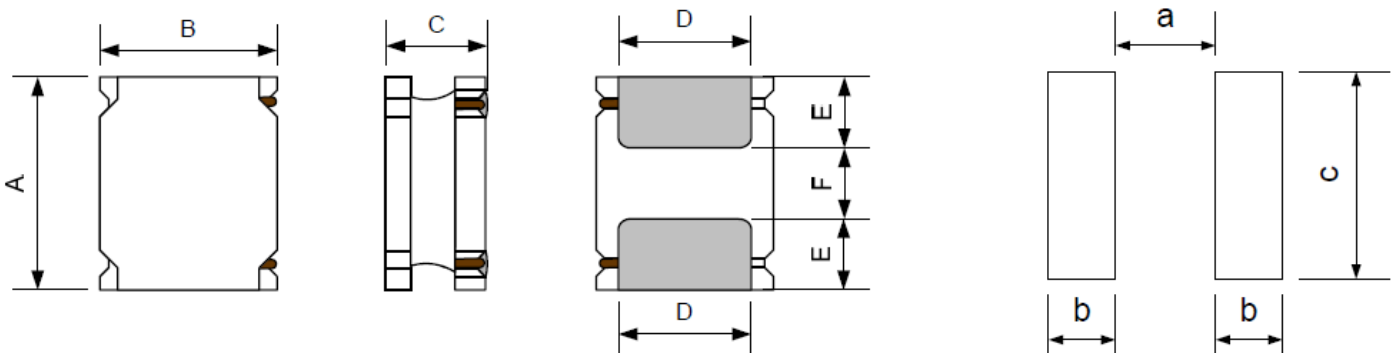

◆ Dimensions

SLW 30/40/50/60/80 Series

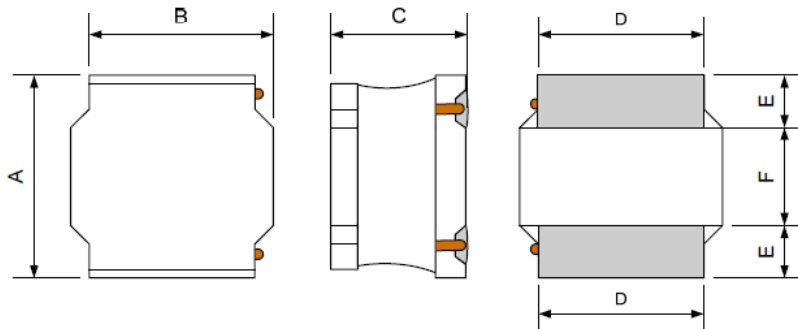

Unit:mm

Series	A	B	C	D	E	F	a Typ.	b Typ.	c Typ.
SLW252010	2.5±0.1	2.0±0.1	1.0Max.	1.5±0.2	0.80±0.2	0.80±0.2	0.8	0.85	2.0
SLW252012	2.5±0.1	2.0±0.1	1.2Max.	1.5±0.2	0.80±0.2	0.80±0.2	0.8	0.85	2.0
SLW3010	3.0±0.2	3.0±0.2	1.0Max.	2.5±0.2	0.75±0.2	1.50±0.2	1.5	0.8	2.7
SLW3012	3.0±0.2	3.0±0.2	1.2Max.	2.5±0.2	0.75±0.2	1.50±0.2	1.5	0.8	2.7
SLW3015	3.0±0.2	3.0±0.2	1.5Max.	2.5±0.2	0.75±0.2	1.50±0.2	1.5	0.8	2.7
SLW4012	4.0±0.2	4.0±0.2	1.2Max.	3.3±0.2	0.95±0.2	2.10±0.2	1.9	1.1	3.7
SLW4018	4.0±0.2	4.0±0.2	1.8Max.	3.3±0.2	0.95±0.2	2.10±0.2	1.9	1.1	3.7
SLW4020	4.0±0.2	4.0±0.2	2.0Max.	3.3±0.2	0.95±0.2	2.10±0.2	1.9	1.1	3.7
SLW4030	4.0±0.2	4.0±0.2	3.0Max.	3.3±0.2	0.95±0.2	2.10±0.2	1.9	1.1	3.7
SLW5020	5.0±0.2	5.0±0.2	2.0Max.	4.0±0.2	1.25±0.2	2.50±0.2	2.1	1.5	4.4
SLW5040	5.0±0.2	5.0±0.2	4.0Max.	4.0±0.2	1.25±0.2	2.50±0.2	2.1	1.5	4.4
SLW6020	6.0±0.3	6.0±0.3	2.0Max.	4.9±0.3	1.55±0.3	2.90±0.3	2.8	1.7	5.7
SLW6028	6.0±0.3	6.0±0.3	2.8Max.	4.9±0.3	1.55±0.3	2.90±0.3	2.8	1.7	5.7
SLW6045	6.0±0.3	6.0±0.3	4.5Max.	4.9±0.3	1.55±0.3	2.90±0.3	2.8	1.7	5.7
SLW8040	8.0±0.3	8.0±0.3	4.2Max.	6.3±0.3	2.00±0.3	4.00±0.3	3.8	2.2	7.5

◆ External Dimensions(L×W×H) [mm]

Series	L×W×H	Series	L×W×H
SLW252010	2.5×2.0×1.0	SLW4030	4.0×4.0×3.0
SLW252012	2.5×2.0×1.2	SLW5020	5.0×5.0×2.0
SLW3010	3.0×3.0×1.0	SLW5040	5.0×5.0×4.0
SLW3012	3.0×3.0×1.2	SLW6020	6.0×6.0×2.0
SLW3015	3.0×3.0×1.5	SLW6028	6.0×6.0×2.8
SLW4012	4.0×4.0×1.2	SLW6045	6.0×6.0×4.5
SLW4018	4.0×4.0×1.8	SLW8040	8.0×8.0×4.0
SLW4020	4.0×4.0×2.0		

◆ Specification

Part Number	Inductance @100KHz,1V (μ H)	DC Resistance(Ω)		Saturation Current(A)		Heat Rating Current (A)
		Max.	Typ.	Min.	Typ.	Typ.
		DCR		Isat		Irms
SLW252010S Series						
SLW252010SR47NST	0.47±30%	0.054	0.047	2.50	3.35	2.75
SLW252010SR68NST	0.68±30%	0.072	0.061	2.20	2.75	2.20
SLW252010S1R0MST	1.0±20%	0.110	0.088	1.85	2.2	1.80
SLW252010S1R5MST	1.5±20%	0.174	0.149	1.80	2.10	1.45
SLW252010S2R2MST	2.2±20%	0.199	0.171	1.30	1.65	1.20
SLW252010S3R3MST	3.3±20%	0.312	0.267	1.05	1.30	1.00
SLW252010S4R7MST	4.7±20%	0.536	0.460	0.95	1.15	0.80
SLW252010S6R8MST	6.8±20%	0.854	0.732	0.78	0.92	0.72
SLW252010S100MST	10±20%	1.050	0.891	0.65	0.78	0.58
SLW252012S Series						
SLW252012SR47NST	0.47±30%	0.045	0.041	3.60	4.03	2.27
SLW252012SR68NST	0.68±30%	0.079	0.072	3.06	3.43	1.73
SLW252012S1R0MST	1.0 ±20%	0.092	0.083	2.68	3.00	1.58
SLW252012S1R2MST	1.2±20%	0.107	0.097	2.38	2.67	1.46
SLW252012S1R5MST	1.5±20%	0.122	0.110	2.24	2.51	1.40
SLW252012S2R2MST	2.2±20%	0.158	0.130	1.85	2.10	1.15
SLW252012S2R7MST	2.7±20%	0.199	0.181	1.71	1.92	1.09
SLW252012S3R3MST	3.3±20%	0.216	0.196	1.61	1.80	1.04
SLW252012S3R6MST	3.6±20%	0.289	0.263	1.48	1.66	0.90
SLW252012S4R3MST	4.3±20%	0.314	0.284	1.37	1.53	0.87
SLW252012S4R7MST	4.7±20%	0.341	0.299	1.18	1.32	0.84
SLW252012S5R1MST	5.1±20%	0.340	0.309	1.18	1.32	0.84
SLW252012S5R6MST	5.6±20%	0.361	0.327	1.13	1.26	0.81
SLW252012S6R2MST	6.2±20%	0.450	0.409	1.03	1.16	0.73
SLW252012S6R8MST	6.8±20%	0.482	0.438	0.98	1.09	0.69
SLW252012S7R5MST	7.5±20%	0.507	0.460	0.97	1.09	0.68
SLW252012S8R2MST	8.2±20%	0.546	0.495	0.98	1.10	0.65
SLW252012S9R1MST	9.1±20%	0.600	0.540	0.95	1.06	0.62
SLW252012S100MST	10±20%	0.621	0.564	0.88	0.97	0.62
SLW252012S120MST	12±20%	0.892	0.810	0.78	0.87	0.51
SLW252012S150MST	15±20%	1.320	1.200	0.68	0.76	0.42
SLW252012S220MST	22±20%	1.640	1.480	0.53	0.59	0.38

◆ Specification

Part Number	Inductance @100KHz, 1V (μH)	DC Resistance ±30% (Ω)	Min.Self-resonant Frequency (MHz)	Saturation Current(A)	Heat Rating Current (A)
		DCR	S.R.F	Isat	Irms
SLW3010S Series					
SLW3010S1R0NST	1.0±30%	0.062	180	1.51	1.45
SLW3010S1R5MST	1.5±20%	0.076	120	1.37	1.30
SLW3010S2R2MST	2.2±20%	0.105	100	1.24	1.09
SLW3010S2R7MST	2.7±20%	0.124	90	1.08	1.02
SLW3010S3R3MST	3.3±20%	0.138	74	1.05	0.96
SLW3010S3R6MST	3.6±20%	0.157	67	1.03	0.90
SLW3010S4R7MST	4.7±20%	0.214	59	0.82	0.77
SLW3010S6R8MST	6.8±20%	0.290	42	0.71	0.66
SLW3010S100MST	10±20%	0.380	39	0.62	0.58
SLW3010S120MST	12±20%	0.480	36	0.55	0.52
SLW3010S150MST	15±20%	0.580	30	0.49	0.47
SLW3010S220MST	22±20%	0.884	28	0.38	0.38
SLW3010S270MST	27±20%	1.026	25	0.32	0.35
SLW3010S330MST	33±20%	1.473	18	0.31	0.30
SLW3010S390MST	39±20%	1.663	18	0.30	0.28
SLW3010S430MST	43±20%	1.710	18	0.25	0.27
SLW3010S470MST	47±20%	1.853	18	0.24	0.26
SLW3010S510MST	51±20%	2.090	18	0.23	0.25
SLW3010S560MST	56±20%	2.204	16	0.23	0.24
SLW3012S Series					
SLW3012SR82NST	0.82±30%	0.030	180	2.15	2.47
SLW3012S1R0NST	1.0±30%	0.040	120	1.96	2.20
SLW3012S1R2MST	1.2±20%	0.045	120	2.33	2.01
SLW3012S1R5MST	1.5±20%	0.045	110	1.70	2.01
SLW3012S1R8MST	1.8±20%	0.055	90	1.59	1.84
SLW3012S2R2MST	2.2±20%	0.075	84	1.26	1.55
SLW3012S2R4MST	2.4±20%	0.068	100	1.21	1.50
SLW3012S2R7MST	2.7±20%	0.085	65	1.20	1.48
SLW3012S3R3MST	3.3±20%	0.100	64	1.10	1.36
SLW3012S4R7MST	4.7±20%	0.120	61	0.95	1.24
SLW3012S6R8MST	6.8±20%	0.190	61	0.79	0.98
SLW3012S100MST	10±20%	0.265	42	0.63	0.83
SLW3012S120MST	12±20%	0.345	32	0.50	0.73
SLW3012S150MST	15±20%	0.360	27	0.47	0.71
SLW3012S180MST	18±20%	0.545	25	0.45	0.58

◆ Specification

Part Number	Inductance @100KHz,1V (μ H)	DC Resistance $\pm 30\%$ (Ω)	Min.Self-resonant Frequency (MHz)	Saturation Current(A)	Heat Rating Current (A)
		DCR	S.R.F	Isat	Irms
SLW3012S Series					
SLW3012S220MST	22 \pm 20%	0.645	23	0.44	0.53
SLW3012S270MST	27 \pm 20%	0.770	21	0.42	0.49
SLW3012S330MST	33 \pm 20%	0.875	18	0.38	0.46
SLW3012S360MST	36 \pm 20%	0.950	18	0.36	0.44
SLW3012S390MST	39 \pm 20%	1.330	18	0.32	0.37
SLW3012S470MST	47 \pm 20%	1.380	14	0.28	0.36
SLW3012S560MST	56 \pm 20%	1.380	14	0.27	0.36
SLW3012S620MST	62 \pm 20%	1.530	12	0.26	0.35
SLW3012S680MST	68 \pm 20%	1.670	12	0.25	0.33
SLW3012S820MST	82 \pm 20%	2.540	12	0.23	0.27
SLW3012S101MST	100 \pm 20%	2.860	12	0.22	0.25
SLW3015S Series					
SLW3015S1R0NST	1.0 \pm 30%	0.037	150	2.44	2.10
SLW3015S1R2MST	1.5 \pm 20%	0.040	110	2.34	1.95
SLW3015S1R5MST	1.2 \pm 20%	0.050	100	2.44	1.70
SLW3015S1R8MST	1.8 \pm 20%	0.050	92	1.86	1.70
SLW3015S2R2MST	2.2 \pm 20%	0.060	86	1.70	1.60
SLW3015S2R7MST	2.7 \pm 20%	0.075	64	1.61	1.43
SLW3015S3R3MST	3.3 \pm 20%	0.080	68	1.45	1.36
SLW3015S3R6MST	3.6 \pm 20%	0.105	59	1.36	1.20
SLW3015S4R3MST	4.3 \pm 20%	0.115	53	1.27	1.14
SLW3015S4R7MST	4.7 \pm 20%	0.125	46	1.17	1.09
SLW3015S5R1MST	5.1 \pm 20%	0.125	49	1.14	1.09
SLW3015S6R2MST	6.2 \pm 20%	0.195	46	1.06	0.86
SLW3015S6R8MST	6.8 \pm 20%	0.200	39	0.92	0.85
SLW3015S100MST	10 \pm 20%	0.250	41	0.87	0.77
SLW3015S120MST	12 \pm 20%	0.320	32	0.74	0.68
SLW3015S150MST	15 \pm 20%	0.350	30	0.70	0.65
SLW3015S180MST	18 \pm 20%	0.430	23	0.59	0.59
SLW3015S220MST	22 \pm 20%	0.460	23	0.55	0.57
SLW3015S330MST	33 \pm 20%	0.820	20	0.47	0.43
SLW3015S390MST	39 \pm 20%	0.995	14	0.43	0.39
SLW3015S430MST	43 \pm 20%	1.060	16	0.39	0.37
SLW3015S470MST	47 \pm 20%	1.250	14	0.37	0.35
SLW3015S560MST	56 \pm 20%	1.280	13	0.35	0.34

◆ Specification

Part Number	Inductance @100KHz,1V (μ H)	DC Resistance \pm 30% (Ω)	Min.Self-resonant Frequency (MHz)	Saturation Current(A)	Heat Rating Current (A)
		DCR	S.R.F	Isat	Irms
SLW3015S Series					
SLW3015S620MST	62 \pm 20%	1.430	13	0.34	0.32
SLW3015S680MST	68 \pm 20%	2.700	11	0.29	0.23
SLW4012S Series					
SLW4012SR82NST	0.82 \pm 30%	0.050	150	3.53	1.65
SLW4012S1R0NST	1.0 \pm 30%	0.050	120	2.61	1.65
SLW4012S1R5MST	1.5 \pm 20%	0.065	90	2.10	1.46
SLW4012S1R8MST	1.8 \pm 20%	0.080	88	2.47	1.32
SLW4012S2R2MST	2.2 \pm 20%	0.080	74	1.76	1.32
SLW4012S2R7MST	2.7 \pm 20%	0.090	71	1.90	1.25
SLW4012S3R3MST	3.3 \pm 20%	0.113	60	1.25	1.12
SLW4012S3R6MST	3.6 \pm 20%	0.110	57	1.20	1.12
SLW4012S4R3MST	4.3 \pm 20%	0.140	54	1.75	1.00
SLW4012S4R7MST	4.7 \pm 20%	0.125	50	1.15	1.05
SLW4012S5R1MST	5.1 \pm 20%	0.155	50	1.21	0.95
SLW4012S6R8MST	6.8 \pm 20%	0.198	40	0.95	0.84
SLW4012S100MST	10 \pm 20%	0.265	33	0.80	0.77
SLW4012S120MST	12 \pm 20%	0.290	32	0.66	0.70
SLW4012S150MST	15 \pm 20%	0.340	25	0.56	0.64
SLW4012S180MST	18 \pm 20%	0.470	23	0.55	0.55
SLW4012S220MST	22 \pm 20%	0.470	20	0.54	0.55
SLW4012S270MST	27 \pm 20%	0.720	18	0.50	0.45
SLW4012S330MST	33 \pm 20%	0.810	17	0.42	0.42
SLW4012S360MST	36 \pm 20%	0.900	14	0.40	0.40
SLW4012S390MST	39 \pm 20%	1.100	16	0.55	0.37
SLW4012S470MST	47 \pm 20%	1.100	12	0.35	0.37
SLW4012S560MST	56 \pm 20%	1.250	11	0.33	0.33
SLW4012S680MST	68 \pm 20%	1.460	11	0.30	0.31
SLW4012S820MST	82 \pm 20%	2.140	11	0.28	0.26
SLW4012S101MST	100 \pm 20%	2.210	9.4	0.25	0.25
SLW4018S Series					
SLW4018S1R0NST	1.0 \pm 30%	0.025	80	4.80	2.00
SLW4018S2R2MST	2.2 \pm 20%	0.045	52	2.70	1.65
SLW4018S3R3MST	3.3 \pm 20%	0.070	44	2.45	1.23
SLW4018S4R7MST	4.7 \pm 20%	0.090	34	1.70	1.20
SLW4018S6R8MST	6.8 \pm 20%	0.110	29	1.45	1.06

◆ Specification

Part Number	Inductance @100KHz,1V (μ H)	DC Resistance $\pm 30\%$ (Ω)	Min.Self-resonant Frequency (MHz)	Saturation Current(A)	Heat Rating Current (A)
		DCR	S.R.F	Isat	Irms
SLW4018S Series					
SLW4018S100MST	10 $\pm 20\%$	0.180	24	1.30	0.84
SLW4018S150MST	15 $\pm 20\%$	0.250	19	0.94	0.65
SLW4018S220MST	22 $\pm 20\%$	0.360	16	0.80	0.59
SLW4018S330MST	33 $\pm 20\%$	0.530	12	0.65	0.49
SLW4018S470MST	47 $\pm 20\%$	0.650	10	0.57	0.42
SLW4018S680MST	68 $\pm 20\%$	1.000	8.3	0.47	0.32
SLW4018S101MST	100 $\pm 20\%$	1.750	6.5	0.40	0.25
SLW4018S151MST	150 $\pm 20\%$	2.500	5.5	0.31	0.22
SLW4018S221MST	220 $\pm 20\%$	4.000	4	0.27	0.17
SLW4020S Series					
SLW4020S1R0NST	1.0 $\pm 30\%$	0.029	75	4.85	2.15
SLW4020S1R2MST	1.2 $\pm 20\%$	0.029	72	5.10	2.15
SLW4020S1R5MST	1.5 $\pm 20\%$	0.035	71	4.45	1.98
SLW4020S2R2MST	2.2 $\pm 20\%$	0.040	49	3.40	1.85
SLW4020S3R3MST	3.3 $\pm 20\%$	0.070	44	3.20	1.40
SLW4020S3R6MST	3.6 $\pm 20\%$	0.055	49	2.80	1.54
SLW4020S4R7MST	4.7 $\pm 20\%$	0.075	42	2.35	1.34
SLW4020S5R1MST	5.1 $\pm 20\%$	0.085	42	2.30	1.27
SLW4020S5R6MST	5.6 $\pm 20\%$	0.090	30	2.20	1.22
SLW4020S6R2MST	6.2 $\pm 20\%$	0.115	36	2.15	1.08
SLW4020S6R8MST	6.8 $\pm 20\%$	0.125	33	2.20	1.04
SLW4020S7R5MST	7.5 $\pm 20\%$	0.115	30	1.85	1.08
SLW4020S8R2MST	8.2 $\pm 20\%$	0.125	27	1.75	1.04
SLW4020S100MST	10 $\pm 20\%$	0.165	26	1.60	0.90
SLW4020S120MST	12 $\pm 20\%$	0.175	26	1.50	0.88
SLW4020S150MST	15 $\pm 20\%$	0.230	24	1.35	0.77
SLW4020S220MST	22 $\pm 20\%$	0.350	15	1.05	0.62
SLW4020S270MST	27 $\pm 20\%$	0.545	14	1.02	0.50
SLW4020S330MST	33 $\pm 20\%$	0.550	11	0.85	0.49
SLW4020S390MST	39 $\pm 20\%$	0.650	11	0.82	0.46
SLW4020S430MST	43 $\pm 20\%$	0.660	10	0.77	0.45
SLW4020S470MST	47 $\pm 20\%$	0.710	10	0.74	0.44
SLW4020S510MST	51 $\pm 20\%$	0.750	10	0.70	0.42
SLW4020S560MST	56 $\pm 20\%$	0.800	10	0.66	0.41
SLW4020S620MST	62 $\pm 20\%$	0.900	9.6	0.65	0.39

◆ Specification

Part Number	Inductance @100KHz,1V (μ H)	DC Resistance $\pm 30\%$ (Ω)	Min.Self-resonant Frequency (MHz)	Saturation Current(A)	Heat Rating Current (A)
		DCR	S.R.F	Isat	Irms
SLW4020S Series					
SLW4020S680MST	68 $\pm 20\%$	1.060	7.7	0.61	0.36
SLW4020S750MST	75 $\pm 20\%$	1.120	7.7	0.60	0.35
SLW4020S820MST	82 $\pm 20\%$	1.170	7.2	0.56	0.34
SLW4020S101MST	100 $\pm 20\%$	1.350	6.3	0.52	0.31
SLW4030S Series					
SLW4030SR91NST	0.91 $\pm 30\%$	0.022	100	6.25	3.15
SLW4030S1R2MST	1.2 $\pm 20\%$	0.025	80	5.80	2.96
SLW4030S1R5MST	1.5 $\pm 20\%$	0.030	62	4.84	2.92
SLW4030S1R8MST	1.8 $\pm 20\%$	0.030	60	5.40	2.92
SLW4030S2R2MST	2.2 $\pm 20\%$	0.035	52	4.90	2.57
SLW4030S3R3MST	3.3 $\pm 20\%$	0.040	38	3.30	2.40
SLW4030S4R3MST	4.3 $\pm 20\%$	0.055	37	2.95	2.10
SLW4030S4R7MST	4.7 $\pm 20\%$	0.060	31	2.90	2.00
SLW4030S5R6MST	5.6 $\pm 20\%$	0.065	30	2.60	1.95
SLW4030S6R2MST	6.2 $\pm 20\%$	0.070	29	2.50	1.85
SLW4030S6R8MST	6.8 $\pm 20\%$	0.090	24	2.75	1.60
SLW4030S7R5MST	7.5 $\pm 20\%$	0.085	26	2.20	1.65
SLW4030S8R2MST	8.2 $\pm 20\%$	0.090	26	2.10	1.60
SLW4030S9R1MST	9.1 $\pm 20\%$	0.095	23	2.00	1.55
SLW4030S100MST	10 $\pm 20\%$	0.100	21	1.95	1.50
SLW4030S120MST	12 $\pm 20\%$	0.135	18	1.70	1.30
SLW4030S150MST	15 $\pm 20\%$	0.190	16	1.65	1.11
SLW4030S180MST	18 $\pm 20\%$	0.200	10	1.40	1.10
SLW4030S220MST	22 $\pm 20\%$	0.225	10	1.30	1.00
SLW4030S330MST	33 $\pm 20\%$	0.330	10	1.10	0.84
SLW4030S360MST	36 $\pm 20\%$	0.335	9.8	1.05	0.83
SLW4030S390MST	39 $\pm 20\%$	0.435	10	1.03	0.73
SLW4030S430MST	43 $\pm 20\%$	0.440	9.2	1.00	0.73
SLW4030S470MST	47 $\pm 20\%$	0.445	8.4	0.95	0.72
SLW4030S510MST	51 $\pm 20\%$	0.470	8.4	0.90	0.70
SLW4030S560MST	56 $\pm 20\%$	0.555	8.4	0.85	0.65
SLW4030S620MST	62 $\pm 20\%$	0.829	7	0.80	0.53
SLW4030S680MST	68 $\pm 20\%$	0.868	7	0.75	0.52
SLW4030S750MST	75 $\pm 20\%$	1.020	6.3	0.70	0.48
SLW4030S820MST	82 $\pm 20\%$	1.060	5.6	0.66	0.47

◆ Specification

Part Number	Inductance @100KHz,1V (μ H)	DC Resistance $\pm 30\%$ (Ω)	Min.Self-resonant Frequency (MHz)	Saturation Current(A)	Heat Rating Current (A)
		DCR	S.R.F	Isat	Irms
SLW4030S Series					
SLW4030S910MST	91 $\pm 20\%$	1.100	5.6	0.65	0.46
SLW4030S101MST	100 $\pm 20\%$	1.150	5.6	0.60	0.45
SLW4030S121MST	120 $\pm 20\%$	1.350	5.4	0.55	0.42
SLW5020S Series					
SLW5020S1R0NST	1.0 $\pm 30\%$	0.018	97	4.33	3.70
SLW5020S1R5MST	1.5 $\pm 20\%$	0.026	80	3.85	3.20
SLW5020S2R2MST	2.2 $\pm 20\%$	0.035	61	3.85	2.90
SLW5020S3R3MST	3.3 $\pm 20\%$	0.044	46	3.25	2.40
SLW5020S4R7MST	4.7 $\pm 20\%$	0.059	33	2.40	2.05
SLW5020S6R8MST	6.8 $\pm 20\%$	0.087	30	1.80	1.70
SLW5020S100MST	10 $\pm 20\%$	0.110	24	1.79	1.50
SLW5020S150MST	15 $\pm 20\%$	0.165	20	1.44	1.25
SLW5020S220MST	22 $\pm 20\%$	0.235	16	1.18	1.05
SLW5020S330MST	33 $\pm 20\%$	0.370	13	0.97	0.83
SLW5020S470MST	47 $\pm 20\%$	0.525	11	0.81	0.70
SLW5020S680MST	68 $\pm 20\%$	0.885	8.8	0.70	0.53
SLW5020S101MST	100 $\pm 20\%$	1.060	7.6	0.57	0.49
SLW5040S Series					
SLW5040S1R5MST	1.5 $\pm 20\%$	0.013	60	7.30	4.45
SLW5040S2R2MST	2.2 $\pm 20\%$	0.017	42	6.50	3.95
SLW5040S3R3MST	3.3 $\pm 20\%$	0.025	32	5.10	3.40
SLW5040S4R7MST	4.7 $\pm 20\%$	0.029	28	4.40	3.10
SLW5040S6R8MST	6.8 $\pm 20\%$	0.043	21	3.80	2.40
SLW5040S100MST	10 $\pm 20\%$	0.055	18	2.90	2.10
SLW5040S150MST	15 $\pm 20\%$	0.089	13	2.30	1.60
SLW5040S220MST	22 $\pm 20\%$	0.126	9	1.90	1.40
SLW5040S330MST	33 $\pm 20\%$	0.192	7	1.60	1.20
SLW5040S470MST	47 $\pm 20\%$	0.283	6	1.30	0.94
SLW6020S Series					
SLW6020SR50NST	0.50 $\pm 30\%$	0.013	130	4.90	4.05
SLW6020SR68NST	0.68 $\pm 30\%$	0.017	120	7.50	3.80
SLW6020SR82NST	0.82 $\pm 30\%$	0.017	110	6.60	3.80
SLW6020S1R0NST	1.0 $\pm 30\%$	0.020	94	4.15	3.25
SLW6020S1R2MST	1.2 $\pm 20\%$	0.022	88	5.90	3.20
SLW6020S1R5MST	1.5 $\pm 20\%$	0.022	79	4.25	3.20

◆ Specification

Part Number	Inductance @100KHz,1V (μ H)	DC Resistance $\pm 30\%$ (Ω)	Min.Self-resonant Frequency (MHz)	Saturation Current(A)	Heat Rating Current (A)
		DCR	S.R.F	Isat	Irms
SLW6020S Series					
SLW6020S1R8MST	1.8 \pm 20%	0.028	68	4.85	2.75
SLW6020S2R0MST	2.0 \pm 20%	0.035	64	4.30	2.45
SLW6020S2R2MST	2.2 \pm 20%	0.028	61	3.75	2.75
SLW6020S2R7MST	2.7 \pm 20%	0.035	56	3.90	2.60
SLW6020S3R3MST	3.3 \pm 20%	0.035	51	3.15	2.60
SLW6020S3R9MST	3.9 \pm 20%	0.049	46	3.25	2.10
SLW6020S4R3MST	4.3 \pm 20%	0.049	44	2.70	2.10
SLW6020S4R7MST	4.7 \pm 20%	0.058	41	3.00	2.00
SLW6020S5R6MST	5.6 \pm 20%	0.058	36	2.40	1.90
SLW6020S6R2MST	6.2 \pm 20%	0.079	35	2.30	1.80
SLW6020S6R8MST	6.8 \pm 20%	0.079	31	2.20	1.80
SLW6020S8R2MST	8.2 \pm 20%	0.105	28	2.10	1.40
SLW6020S100MST	10 \pm 20%	0.105	27	1.75	1.40
SLW6020S120MST	12 \pm 20%	0.120	23	1.70	1.35
SLW6020S150MST	15 \pm 20%	0.145	21	1.50	1.20
SLW6020S180MST	18 \pm 20%	0.175	19	1.23	1.10
SLW6020S220MST	22 \pm 20%	0.204	16	1.25	1.00
SLW6028S Series					
SLW6028S1R5MST	1.5 \pm 20%	0.013	65	6.00	4.58
SLW6028S2R2MST	2.2 \pm 20%	0.015	56	5.10	4.09
SLW6028S2R7MST	2.7 \pm 20%	0.020	48	3.80	3.75
SLW6028S3R3MST	3.3 \pm 20%	0.025	41	3.63	3.48
SLW6028S4R7MST	4.7 \pm 20%	0.030	35	3.00	3.08
SLW6028S5R1MST	5.1 \pm 20%	0.035	33	3.55	2.89
SLW6028S6R2MST	6.2 \pm 20%	0.040	30	3.05	2.58
SLW6028S6R8MST	6.8 \pm 20%	0.047	27	2.85	2.40
SLW6028S8R2MST	8.2 \pm 20%	0.055	24	2.60	2.25
SLW6028S9R1MST	9.1 \pm 20%	0.060	24	2.55	2.15
SLW6028S100MST	10 \pm 20%	0.072	23	2.04	1.95
SLW6028S120MST	12 \pm 20%	0.080	18	1.80	1.85
SLW6028S150MST	15 \pm 20%	0.125	18	1.75	1.45
SLW6028S180MST	18 \pm 20%	0.120	15	1.52	1.45
SLW6028S220MST	22 \pm 20%	0.140	14	1.60	1.40
SLW6028S270MST	27 \pm 20%	0.155	13	1.50	1.32

◆ Specification

Part Number	Inductance @100KHz,1V (μ H)	DC Resistance $\pm 30\%$ (Ω)	Min.Self-resonant Frequency (MHz)	Saturation Current(A)	Heat Rating Current (A)
		DCR	S.R.F	Isat	Irms
SLW6028S Series					
SLW6028S330MST	33 $\pm 20\%$	0.185	12	1.35	1.22
SLW6028S360MST	36 $\pm 20\%$	0.215	11	1.25	1.13
SLW6028S390MST	39 $\pm 20\%$	0.225	11	1.25	1.10
SLW6028S430MST	43 $\pm 20\%$	0.235	11	1.20	1.07
SLW6028S470MST	47 $\pm 20\%$	0.245	9.5	1.15	1.06
SLW6028S510MST	51 $\pm 20\%$	0.265	9.5	1.05	1.01
SLW6028S620MST	62 $\pm 20\%$	0.345	7.7	0.95	0.89
SLW6028S680MST	68 $\pm 20\%$	0.360	7.7	0.95	0.86
SLW6028S750MST	75 $\pm 20\%$	0.410	7.7	0.90	0.81
SLW6028S820MST	82 $\pm 20\%$	0.445	7.7	0.90	0.78
SLW6045S Series					
SLW6045SR82NST	0.82 $\pm 30\%$	0.008	140	10.40	5.90
SLW6045S1R0NST	1.0 $\pm 30\%$	0.011	100	9.85	5.14
SLW6045S1R2MST	1.2 $\pm 20\%$	0.010	100	8.35	5.40
SLW6045S1R5MST	1.5 $\pm 20\%$	0.012	65	8.80	4.95
SLW6045S1R8MST	1.8 $\pm 20\%$	0.012	74	7.60	4.95
SLW6045S2R2MST	2.2 $\pm 20\%$	0.014	52	6.75	4.60
SLW6045S2R3MST	2.3 $\pm 20\%$	0.021	60	6.00	3.50
SLW6045S2R7MST	2.7 $\pm 20\%$	0.015	38	5.75	4.30
SLW6045S3R0MST	3.0 $\pm 20\%$	0.020	35	5.60	3.80
SLW6045S3R3MST	3.3 $\pm 20\%$	0.021	32	5.90	3.70
SLW6045S3R6MST	3.6 $\pm 20\%$	0.021	28	5.25	3.70
SLW6045S4R3MST	4.3 $\pm 20\%$	0.023	23	4.45	3.50
SLW6045S4R7MST	4.7 $\pm 20\%$	0.026	24	4.97	3.30
SLW6045S5R1MST	5.1 $\pm 20\%$	0.026	23	4.40	3.30
SLW6045S5R6MST	5.6 $\pm 20\%$	0.029	23	4.15	3.15
SLW6045S6R2MST	6.2 $\pm 20\%$	0.031	26	4.43	3.00
SLW6045S6R8MST	6.8 $\pm 20\%$	0.031	20	3.90	3.00
SLW6045S7R5MST	7.5 $\pm 20\%$	0.034	18	3.50	2.90
SLW6045S8R2MST	8.2 $\pm 20\%$	0.043	21	3.90	2.60
SLW6045S9R1MST	9.1 $\pm 20\%$	0.043	17	3.35	2.60
SLW6045S100MST	10 $\pm 20\%$	0.048	15	3.20	2.45
SLW6045S120MST	12 $\pm 20\%$	0.058	13	2.80	2.20
SLW6045S150MST	15 $\pm 20\%$	0.068	12	2.50	2.05

◆ Specification

Part Number	Inductance @100KHz,1V (μ H)	DC Resistance $\pm 30\%$ (Ω)	Min.Self-resonant Frequency (MHz)	Saturation Current(A)	Heat Rating Current (A)
		DCR	S.R.F	Isat	Irms
SLW6045S Series					
SLW6045S180MST	18 $\pm 20\%$	0.081	10	2.20	1.85
SLW6045S220MST	22 $\pm 20\%$	0.089	10	2.05	1.80
SLW6045S270MST	27 $\pm 20\%$	0.102	9.2	1.90	1.65
SLW6045S300MST	30 $\pm 20\%$	0.132	7.8	1.70	1.50
SLW6045S330MST	33 $\pm 20\%$	0.137	7.8	1.65	1.45
SLW6045S360MST	36 $\pm 20\%$	0.173	7.8	1.62	1.40
SLW6045S390MST	39 $\pm 20\%$	0.180	7.8	1.50	1.25
SLW6045S430MST	43 $\pm 20\%$	0.200	7.7	1.63	1.20
SLW6045S470MST	47 $\pm 20\%$	0.200	6.4	1.40	1.20
SLW6045S510MST	51 $\pm 20\%$	0.207	6.4	1.35	1.15
SLW6045S560MST	56 $\pm 20\%$	0.221	6.4	1.30	1.10
SLW6045S620MST	62 $\pm 20\%$	0.235	6.4	1.25	1.10
SLW6045S680MST	68 $\pm 20\%$	0.289	6.4	1.20	1.00
SLW6045S750MST	75 $\pm 20\%$	0.305	5	1.15	0.95
SLW6045S820MST	82 $\pm 20\%$	0.341	4.9	1.05	0.90
SLW6045S910MST	91 $\pm 20\%$	0.359	4.9	1.00	0.85
SLW6045S101MST	100 $\pm 20\%$	0.433	4.2	0.95	0.80
SLW6045S121MST	120 $\pm 20\%$	0.484	4.2	0.85	0.77
SLW6045S151MST	150 $\pm 20\%$	0.580	4.2	0.80	0.70
SLW6045S221MST	220 $\pm 20\%$	0.834	3.5	0.70	0.59
SLW6045S331MST	330 $\pm 20\%$	1.270	2.8	0.57	0.57
SLW8040S Series					
SLW8040SR82NST	0.82 $\pm 30\%$	0.008	94	13.80	6.30
SLW8040S1R0NST	1.0 $\pm 30\%$	0.008	89	9.85	6.30
SLW8040S1R5MST	1.5 $\pm 20\%$	0.010	67	8.15	5.65
SLW8040S2R0MST	2.0 $\pm 20\%$	0.012	43	9.25	5.15
SLW8040S2R2MST	2.2 $\pm 20\%$	0.012	41	7.10	5.15
SLW8040S3R0MST	3.0 $\pm 20\%$	0.014	32	6.10	4.70
SLW8040S3R3MST	3.3 $\pm 20\%$	0.017	27	6.50	4.40
SLW8040S3R6MST	3.6 $\pm 20\%$	0.017	30	7.52	4.35
SLW8040S3R9MST	3.9 $\pm 20\%$	0.017	26	5.75	4.35
SLW8040S4R7MST	4.7 $\pm 20\%$	0.019	24	5.90	4.10
SLW8040S5R1MST	5.1 $\pm 20\%$	0.019	22	4.70	4.05

◆ Specification

Part Number	Inductance @100KHz,1V (μ H)	DC Resistance $\pm 30\%$ (Ω)	Min.Self-resonant Frequency (MHz)	Saturation Current(A)	Heat Rating Current (A)
		DCR	S.R.F	Isat	Irms
SLW8040S Series					
SLW8040S5R6MST	5.6 \pm 20%	0.021	24	6.00	3.85
SLW8040S6R2MST	6.2 \pm 20%	0.021	20	4.45	3.85
SLW8040S6R8MST	6.8 \pm 20%	0.024	20	4.55	3.60
SLW8040S8R2MST	8.2 \pm 20%	0.026	17	4.20	3.45
SLW8040S100MST	10 \pm 20%	0.029	15	3.60	3.30
SLW8040S150MST	15 \pm 20%	0.047	12	2.95	2.60
SLW8040S180MST	18 \pm 20%	0.053	11	2.70	2.40
SLW8040S220MST	22 \pm 20%	0.069	9.5	2.40	2.10
SLW8040S270MST	27 \pm 20%	0.078	9.2	2.15	2.00
SLW8040S330MST	33 \pm 20%	0.097	7.8	2.05	1.80
SLW8040S360MST	36 \pm 20%	0.102	7.8	2.00	1.75
SLW8040S390MST	39 \pm 20%	0.107	7.8	1.95	1.70
SLW8040S430MST	43 \pm 20%	0.113	7.8	1.90	1.65
SLW8040S470MST	47 \pm 20%	0.136	6.4	1.75	1.55
SLW8040S510MST	51 \pm 20%	0.142	6.4	1.70	1.50
SLW8040S560MST	56 \pm 20%	0.148	6.4	1.55	1.45
SLW8040S620MST	62 \pm 20%	0.182	6.4	1.50	1.30
SLW8040S680MST	68 \pm 20%	0.196	4.9	1.45	1.25
SLW8040S750MST	75 \pm 20%	0.211	4.9	1.35	1.20
SLW8040S820MST	82 \pm 20%	0.225	5.9	1.30	1.15
SLW8040S910MST	91 \pm 20%	0.272	4.9	1.20	1.05
SLW8040S101MST	100 \pm 20%	0.290	4.2	1.15	1.00
SLW8040S121MST	120 \pm 20%	0.334	3.5	1.05	0.95
SLW8040S151MST	150 \pm 20%	0.410	3.5	1.10	0.85
SLW8040S221MST	220 \pm 20%	0.599	3.5	0.85	0.80
SLW8040S331MST	330 \pm 20%	0.889	2.8	0.68	0.64

◆ Note

- 1: All test data is referenced to 20°C ambient;
- 2: Rated current: Isat or Irms, whichever is smaller;
- 3: Isat: DC current at which the inductance drops approximate 30% from its value without current;
- 4: Irms: DC current that causes the temperature rise ($\Delta T = 40^\circ\text{C}$) from 20°C ambient.

◆ **TYPICAL ELECTRICAL CHARACTERISTICS**

SLW252010S Series

Temperature vs. DC Current Characteristics



Inductance vs. DC Current Characteristics



SLW252012S Series

Temperature vs. DC Current Characteristics



Inductance vs. DC Current Characteristics

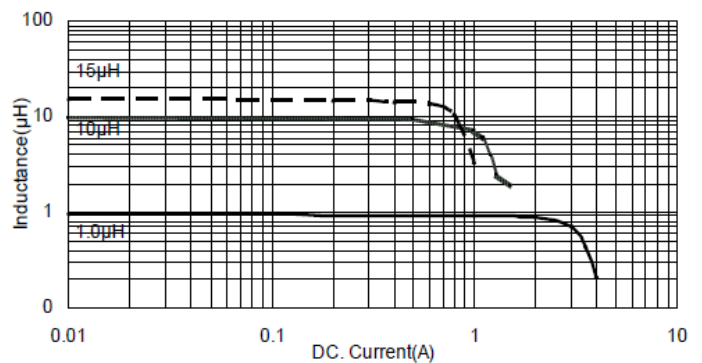

SLW3010S Series

Temperature vs. DC Current Characteristics



Inductance vs. DC Current Characteristics



◆ TYPICAL ELECTRICAL CHARACTERISTICS

SLW3012S Series

Temperature vs. DC Current Characteristics



Inductance vs. DC Current Characteristics



SLW3015S Series

Temperature vs. DC Current Characteristics



Inductance vs. DC Current Characteristics

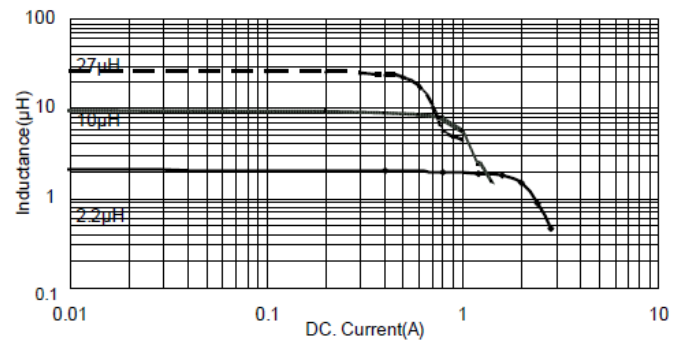

SLW4012S Series

Temperature vs. DC Current Characteristics



Inductance vs. DC Current Characteristic



◆ **TYPICAL ELECTRICAL CHARACTERISTICS**

SLW4018S Series

Temperature vs. DC Current Characteristics



Inductance vs. DC Current Characteristics



SLW4020S Series

Temperature vs. DC Current Characteristics



Inductance vs. DC Current Characteristics

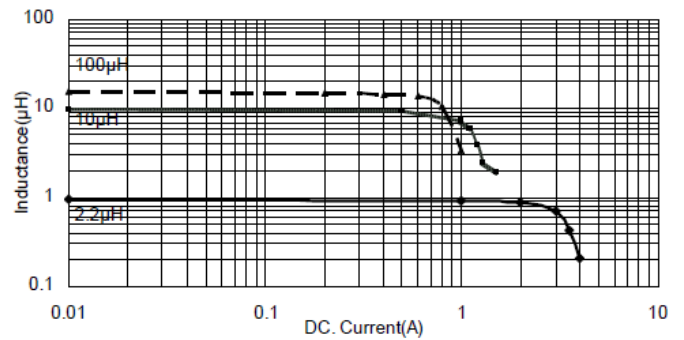

SLW4030S Series

Temperature vs. DC Current Characteristics

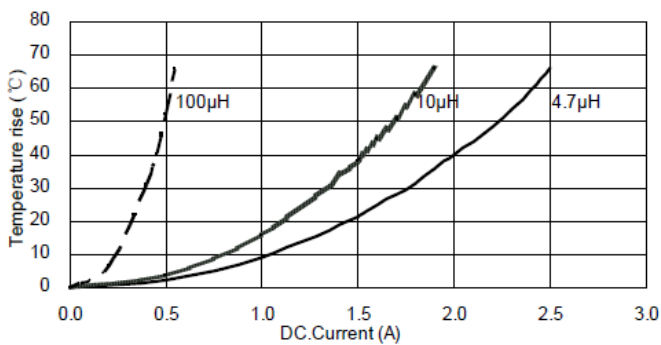

Inductance vs. DC Current Characteristics

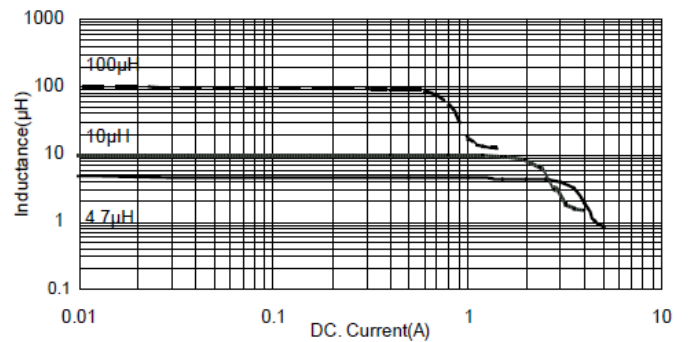

◆ **TYPICAL ELECTRICAL CHARACTERISTICS**

SLW5020S Series

Temperature vs. DC Current Characteristics



Inductance vs. DC Current Characteristics

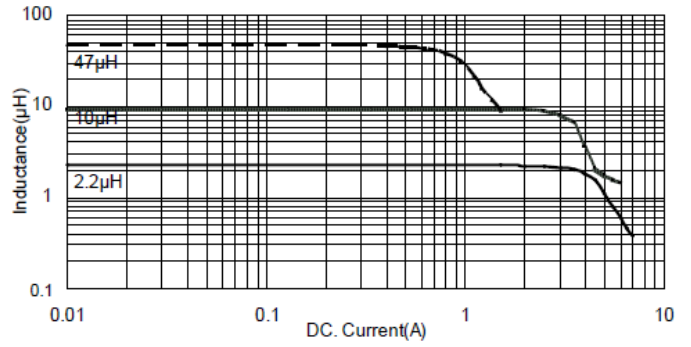

SLW5040S Series

Temperature vs. DC Current Characteristics



Inductance vs. DC Current Characteristics

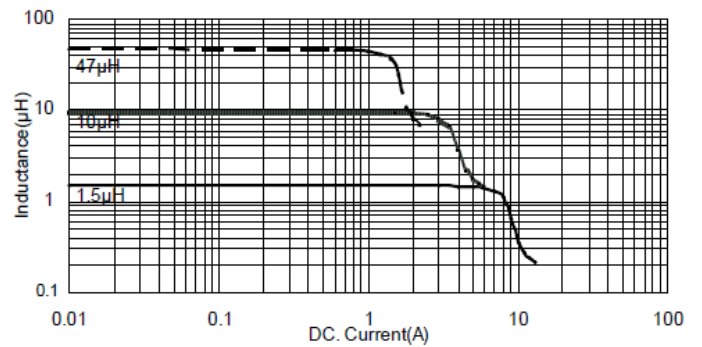

SLW6020S Series

Temperature vs. DC Current Characteristics



Inductance vs. DC Current Characteristics

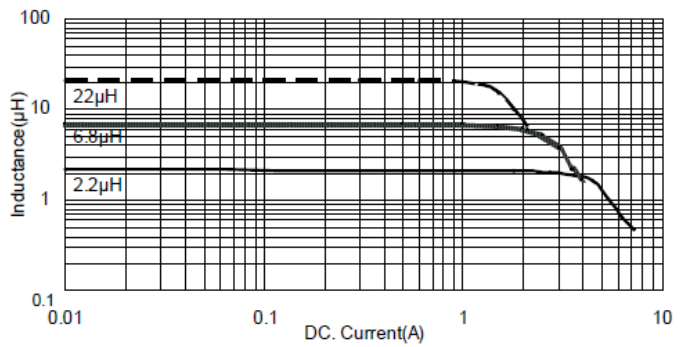

◆ TYPICAL ELECTRICAL CHARACTERISTICS

SLW6028S Series

Temperature vs. DC Current Characteristics



Inductance vs. DC Current Characteristics

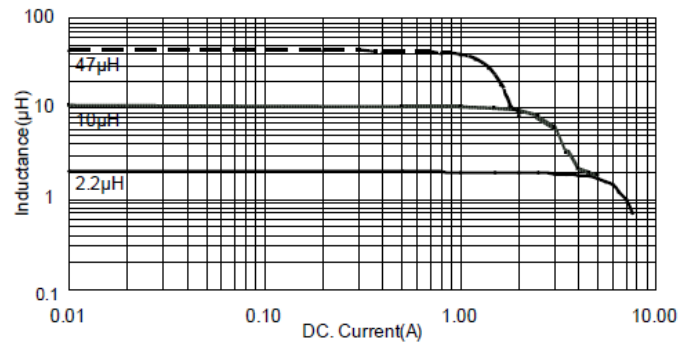

SLW6045S Series

Temperature vs. DC Current Characteristics



Inductance vs. DC Current Characteristics

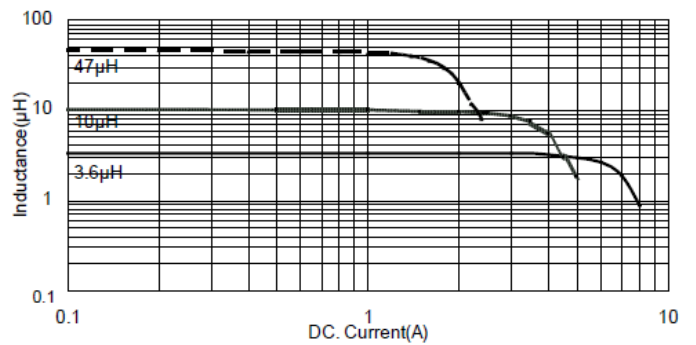

SLW8040S Series

Temperature vs. DC Current Characteristics



Inductance vs. DC Current Characteristics

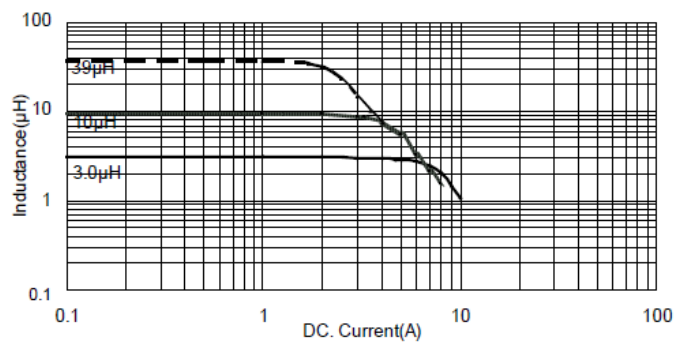

◆ **Package**

Size EIA (EIA)	SLW2520S	SLW3010S	SLW3012S	SLW3015S	SLW4012S	SLW4018S	SLW4020S
Standard Packing Quantity (pcs / reel)	2,000	2,000	2,000	2,000	4,500	3,000	3,000
	SLW4030S	SLW5020S	SLW5040S	SLW6020S	SLW6028S	SLW6045S	SLW8040S
	2,000	2,500	1,500	2,500	2,000	1,500	1,000

X-ON Electronics

Largest Supplier of Electrical and Electronic Components

Click to view similar products for [Fixed Inductors](#) category:

Click to view products by [Sunltech](#) manufacturer:

Other Similar products are found below :

[CR32NP-100KC](#) [CR32NP-151KC](#) [CR32NP-180KC](#) [CR32NP-181KC](#) [CR32NP-1R5MC](#) [CR32NP-390KC](#) [CR32NP-3R9MC](#) [CR32NP-680KC](#) [CR32NP-820KC](#) [CR32NP-8R2MC](#) [CR43NP-390KC](#) [CR43NP-560KC](#) [CR43NP-680KC](#) [CR54NP-181KC](#) [CR54NP-470LC](#) [CR54NP-820KC](#) [CR54NP-8R5MC](#) [70F224AI](#) [MGDQ4-00004-P](#) [MHL1ECTTP18NJ](#) [MHQ1005P10NJ](#) [MHQ1005P1N0S](#) [MHQ1005P2N4S](#) [MHQ1005P3N6S](#) [MHQ1005P5N1S](#) [MHQ1005P8N2J](#) [PE-51506NL](#) [PE-53601NL](#) [PE-53602NL](#) [PE-53630NL](#) [PE-53824SNLT](#) [PE-92100NL](#) [PG0434.801NLT](#) [PG0936.113NLT](#) [9220-20](#) [9310-16](#) [PM06-2N7](#) [PM06-39NJ](#) [A01TK](#) [1206CS-471XJ](#) [HC2LP-R47-R](#) [HC2-R47-R](#) [HC3-2R2-R](#) [HCF1305-3R3-R](#) [1206CS-151XG](#) [RCH664NP-140L](#) [RCH664NP-4R7M](#) [RCH8011NP-221L](#) [RCP1317NP-332L](#) [RCP1317NP-391L](#)