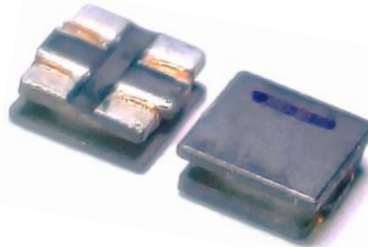
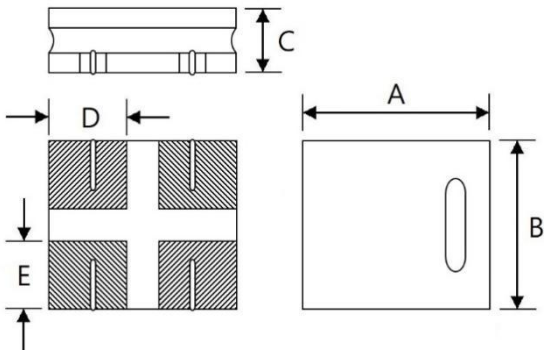

◆ Style and Dimensions (mm)

| | |
|---|----------|
| A | 4.00±0.2 |
| B | 4.00±0.2 |
| C | 1.60 Max |
| D | 1.55 Typ |
| E | 1.40 Typ |

◆ Electrical Characteristics

| P/N | Z (Ω) Common Mode | | DCR (Ω) | DC Current (A) | Rated Voltage | In sulation Resistance | Withstan d Voltage |
|----------------|----------------------|---------------------|---------|----------------|---------------|------------------------|--------------------|
| | Impedance at 10MHz | Impedance at 100MHz | ±40% | Max | Vdc (V) Typ | IR (MΩ) Min | Vdc (V) Typ |
| SMW4015S101NTT | 10±40% | 100 Typ | 0.016 | 3.1 | 60 | 10 | 150 |
| SMW4015S251KTT | 25±40% | 250 Typ | 0.024 | 2.6 | 60 | 10 | 150 |
| SMW4015S401KTT | 38±40% | 400 Typ | 0.03 | 2.1 | 60 | 10 | 150 |
| SMW4015S501KTT | 50±40% | 500 Typ | 0.03 | 2.1 | 60 | 10 | 150 |
| SMW4015S601KTT | 53±40% | 600 Typ | 0.03 | 2.0 | 60 | 10 | 150 |
| SMW4015S851KTT | 65±40% | 850 Typ | 0.04 | 2.0 | 60 | 10 | 150 |
| SMW4015S102KTT | 65±40% | 1000 Typ | 0.04 | 2.0 | 60 | 10 | 150 |
| SMW4015S172HTT | 100±40% | 1700 Typ | 0.06 | 1.5 | 60 | 10 | 150 |
| SMW4015S242HTT | 120±40% | 2400 Typ | 0.075 | 1.4 | 60 | 10 | 150 |
| SMW4015S302HTT | 180±40% | 2200 Typ | 0.12 | 1.1 | 60 | 10 | 150 |

※ Operating temperature : -40 to +105℃

Storage temp. and humidity: Less than 40℃ and 60% RH.

Typical Heat Rating DC Current would cause an approximately ΔT of 40℃

If Use Wave soldering is there will be some risk

Re-flow soldering temperatures below 240 degrees, there will be unwitting risk

Solder standard according to IPC-A-610D 8.2.1 Chip Components - Bottom Only Terminations

◆ Performance Curves

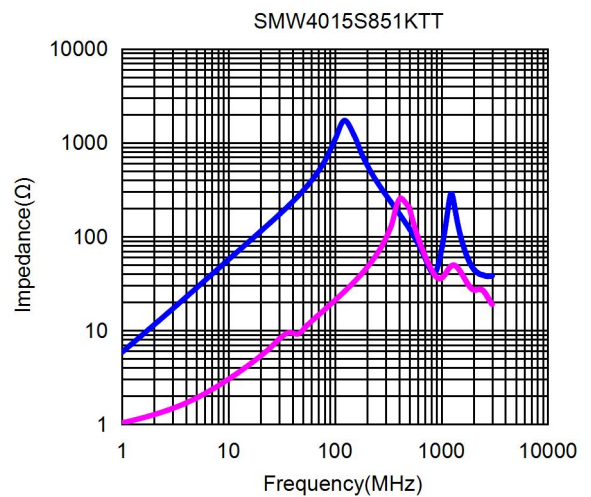
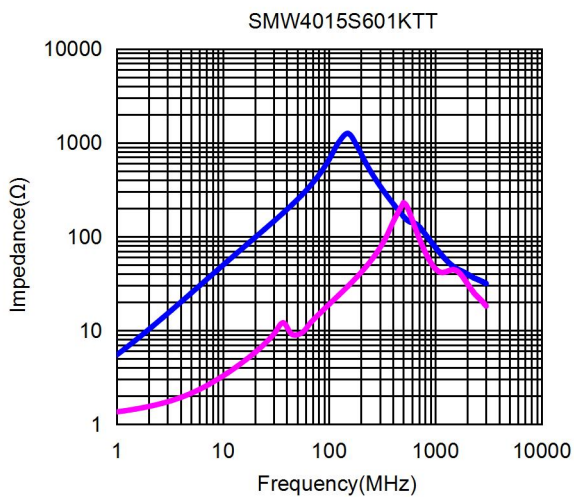
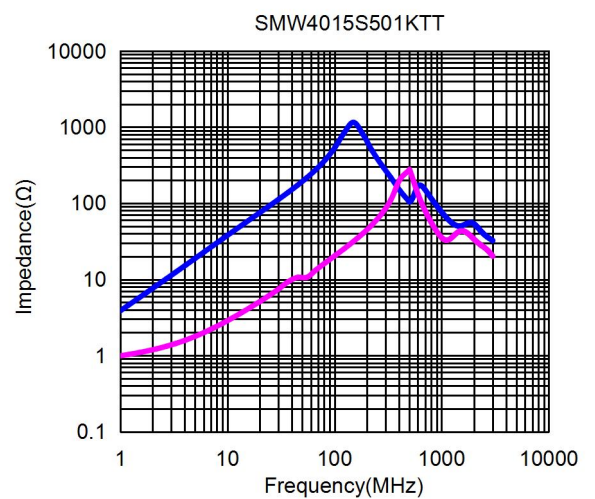
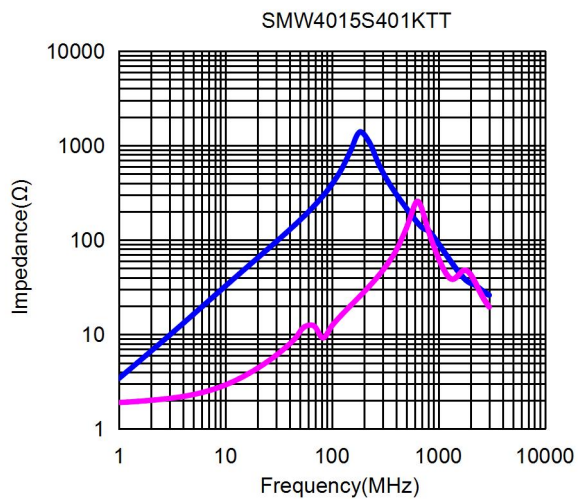
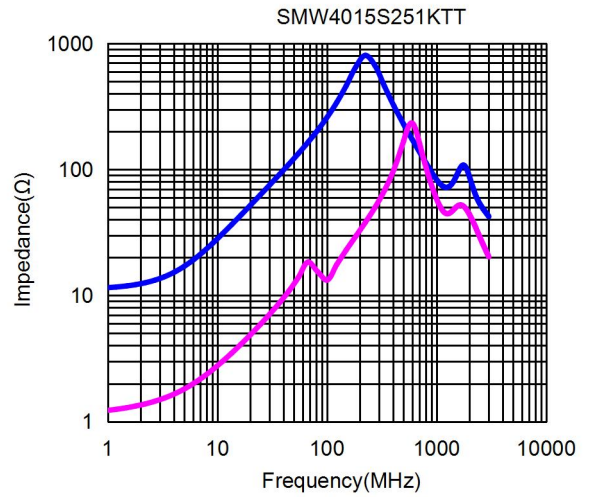
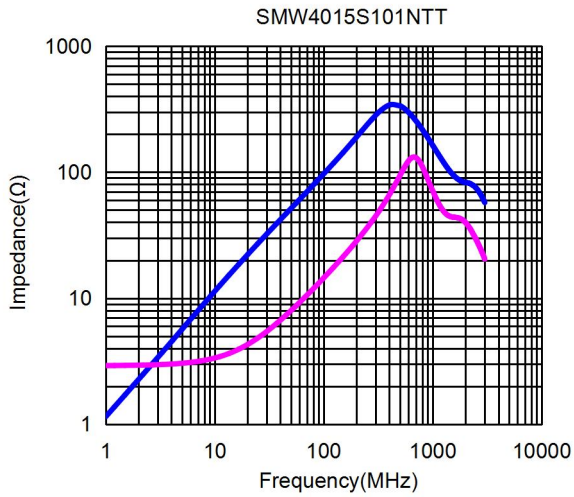

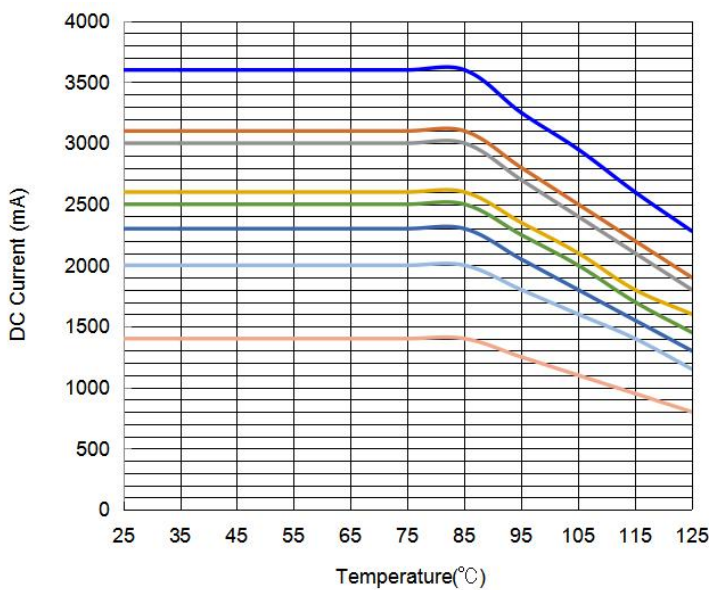
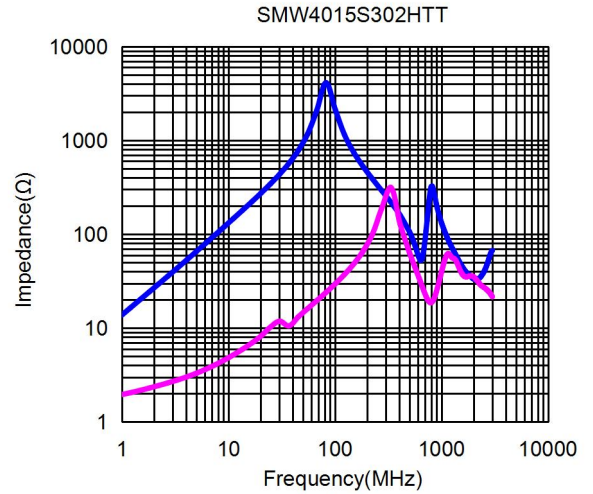
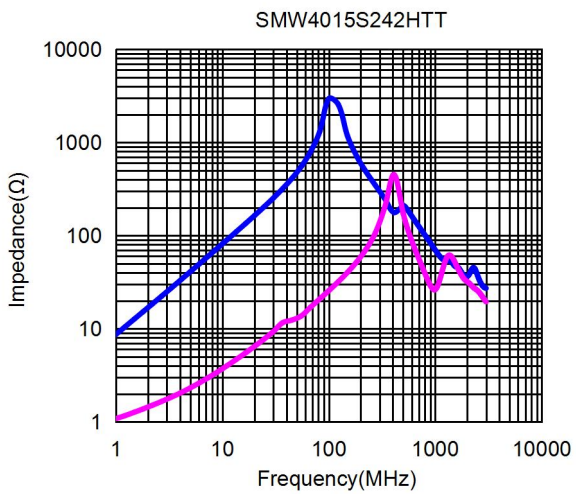
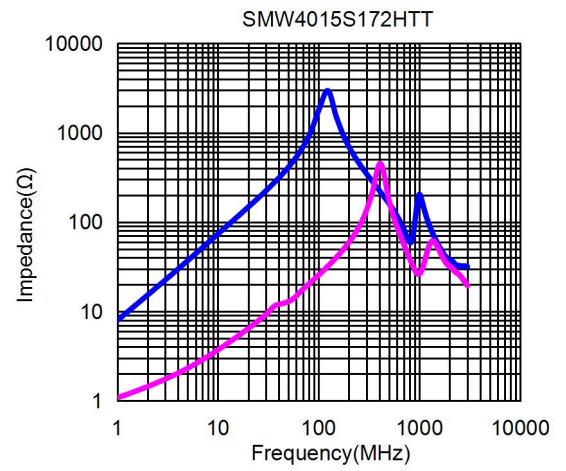
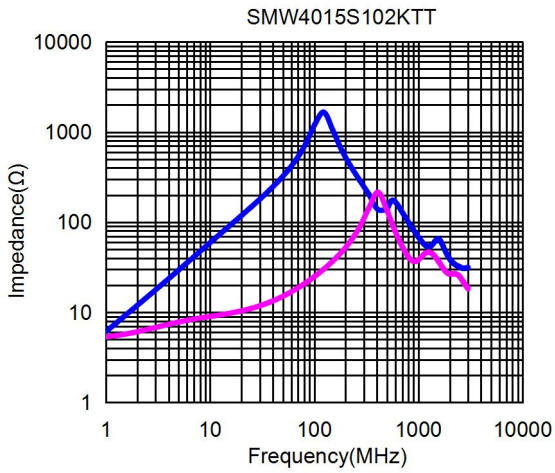

✘ In operating temperature exceeding +85°C, derating of current is necessary for PCN4015 series. Please apply the derating curve shown in chart according to the operating temperature.

◆ Mechanical Performance

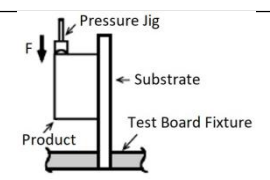
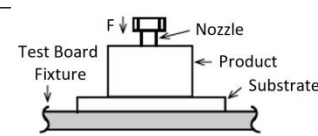
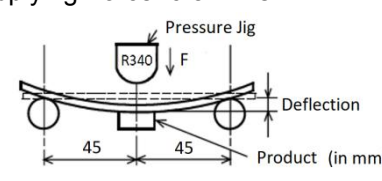
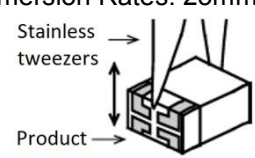
| No. | Item | Specifications | Test Method | | | | | | | | |
|------------------------------|------------------------------------|--|--|-------------|------------------------------|-------------|------|-----------|-------------------|-------------|---|
| 1 | Appearance and Dimensions | Style and Dimensions | Visual Inspection and Measured with Slide Calipers. | | | | | | | | |
| 2 | Bonding Strength and Core Strength | No Evidence of Chipping, Breakage. No Evidence of Coming off Glass-Epoxy Substrate. | Applying Force (F): 10N Applying Time: 5± 1s  | | | | | | | | |
| 3 | Body Strength | No Evidence of Chipping, Breakage. | Applying Force (F): 10N Applying Time: 5± 1s  | | | | | | | | |
| 4 | Bonding Strength | Meet Table 1. Table 1 | Substrate: Glass-Epoxy (t=1.6mm) Deflection: 2.0mm Keeping Time: 30s Speed of Applying Force: 0.5mm/s  | | | | | | | | |
| 5 | Vibration | <table border="1"> <tr> <td>Appearance</td> <td>No Damaged.</td> </tr> <tr> <td>Impedance Change (at 100MHz)</td> <td>Within ±20%</td> </tr> <tr> <td>I.R.</td> <td>10MΩ Min.</td> </tr> <tr> <td>Withstand Voltage</td> <td>No Damaged.</td> </tr> </table> | Appearance | No Damaged. | Impedance Change (at 100MHz) | Within ±20% | I.R. | 10MΩ Min. | Withstand Voltage | No Damaged. | Products Shall be Soldered on the Substrate. Oscillation Frequency: 10 to 55 to 10Hz for 1 Min. Total Amplitude: 1.5mm Testing Time: A Period of 2 Hours in Each of 3 Mutually Perpendicular Directions (Total 6 Hours). |
| Appearance | No Damaged. | | | | | | | | | | |
| Impedance Change (at 100MHz) | Within ±20% | | | | | | | | | | |
| I.R. | 10MΩ Min. | | | | | | | | | | |
| Withstand Voltage | No Damaged. | | | | | | | | | | |
| 6 | Drop | | Products Shall be Dropped Concrete or Steel Board. Method: Free Fall Height: 1m The Number of Times: 10 Times | | | | | | | | |
| 7 | Solderability | The electrodes Shall be at Least 90% Covered with New Solder coating. | Flux: Ethanol Solution of Rosin, 25 (wt)% Pre-Heating: 150± 10°C, 1 Minute. Solder: (1) Su/Pb=60/40, (2) Su-3.0Ag-0.5Cu Solder Temperature: (1) 230±5°C, (2) 230±5°C Immersion Time: 4± 1s Immersion and Immersion Rates: 25mm/s  | | | | | | | | |
| 8 | Resistance to Soldering Heat | Meet Table 1. | Flux: Ethanol Solution of Rosin, 25 (wt)% Pre-Heating: 150± 10°C, 1 Minute. Solder: (1) Su/Pb=60/40, (2) Su-3.0Ag-0.5Cu Solder Temperature: 270±5°C Immersion Time: 5± 1s Immersion and Immersion Rates: 25mm/s Then Measured After Exposure in the Room Condition for 4 to 48 Hours. | | | | | | | | |

◆ Enviromental Performance
Product shall be solderd on the glass-epoxy substrate (t=1.6mm)

| No. | Item | Specifications | Test Method |
|-----|-------------------|----------------|---|
| 1 | Temperature Cycle | Meet Table 1. | 1 Cycle 1 step: -40°C (+0, -3)°C / 30min (+3, -0) min 2 step: Ordinary Temp. / 3 min max. 3 step: +125°C (+3, -0)°C / 30min (+3, -0) min 4 step: Ordinary Temp. / 3 min max. Total of 10 Cycles Then Measured After Exposure in the Room Condition for 4 to 48 Hours. |
| 2 | Humidity | | Temperature: 40±2°C Humidity: 90 to 95% (RH) Time: 1000h (+48 h, -0 h) Then Measured After Exposure in the Room Condition for 4 to 48 Hours. |
| 3 | Humidity Load | | Temperature: 40±2°C Humidity: 90 to 95% (RH) Test Voltage: Rated Voltage Time: 1000h (+48 h, -0 h) Then Measured After Exposure in the Room Condition for 4 to 48 Hours. (Ref. Item) |
| 4 | Heat Life | | Temperature: 85±2°C Humidity: 90 to 95% (RH) Test Voltage: Rated Voltage Time: 1000h (+48 h, -0 h) Then Measured After Exposure in the Room Condition for 4 to 48 Hours. (Ref. Item) |
| 5 | Cold Resistance | | Temperature: -40±2°C Time: 1000h (+48 h, -0 h) Then Measured After Exposure in the Room Condition for 4 to 48 Hours. (Ref. Item) |

◆ Terminal to be Tested
When measuring and suppling the voltage,the following terminal is applied

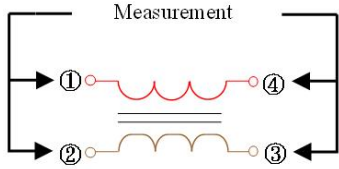
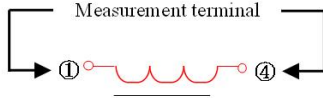
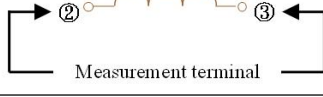
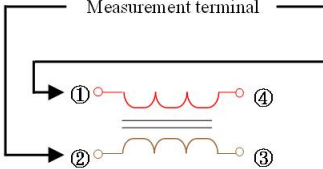
| No. | Item | Terminal to be Tested |
|-----|--|--|
| 1 | Impedance (Ω) (Measurement Terminal) |  |
| 2 | DC Resistance (Ω) (Measurement Terminal) |  |
| 3 | DC Current (A) (Measurement Terminal) |  |
| 4 | Insulation Resistance (I.R.) (Measurement Terminal) |  |
| 5 | Withstanding Voltage (V) (Measurement Terminal) | |
| 6 | Rated Voltage (V) (Measurement Terminal) | |
| 7 | Humidity Load (Supply Terminal) | |
| 8 | Heat Life (Supply Terminal) | |

◆ Soldering and Mounting

soldering

Mildly activated rosin fluxes are preferred. Terminations are suitable for re-flow soldering systems

If hand soldering cannot be avoided, the preferred technique is the utilization of hot air soldering tools

Solder re flow

Recommended temperature profiles for re-flow soldering in Figure 1

Soldering Iron(Figure 2)

Products attachment with a soldering iron is discouraged due to the inherent process control limitations. In the event that a soldering iron must be employed the following precautions are recommended.

- Preheat circuit and products to 150°C
- Never contact the ceramic with the iron tip
- 355°C tip temperature (max.)
- 1.0mm tip diameter (max.)
- Use a 20-watt soldering iron with tip diameter of 1.0mm

Reflow Soldering

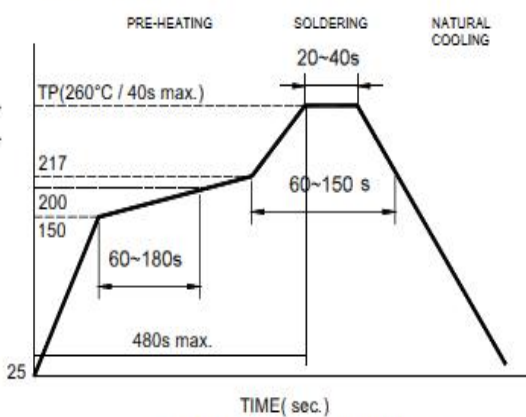

Reflow times: 3 times max.

Fig.1

Iron Soldering

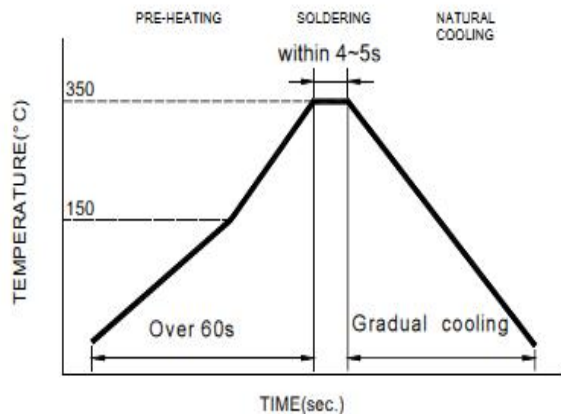

Iron Soldering times: 1 times max.

Fig.2

◆ Recommended PC Board Pattern

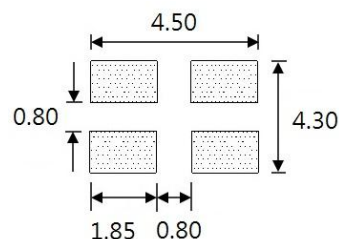
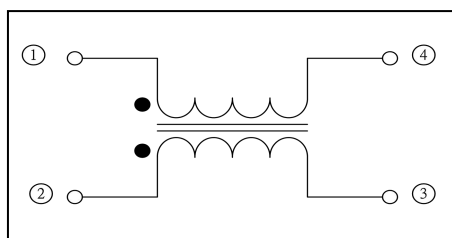

Guideline of solder paste thickness: $\geq 100\mu\text{m}$

Solderability is subject to reflow conditions and thermal conductivity

Please make sure that your product has been evaluated in view of your specifications with our product being mounted to your product

◆ Application Notice

● Storage Conditions(component level)

To maintain the solderability of terminal electrodes

- 1.HUNGTRON products meet IPC/JEDEC J-STD-020D standard-MSL, level 1
- 2.Temperature and humidity conditions: Less than 40°C and 60% RH
- 3.Recommended products should be used within 12 months form the time of delivery
- 4.The packaging material should be kept where no chlorine or sulfur exists in the air

● Transportation

- 1.Products should be handled with care to avoid damage or contamination from perspiration and skin oils
- 2.The use of tweezers or vacuum pick up is strongly recommended for individual components.
- 3.Bulk handling should ensure that abrasion and mechanical shock are minimized

◆ Reel Dimension

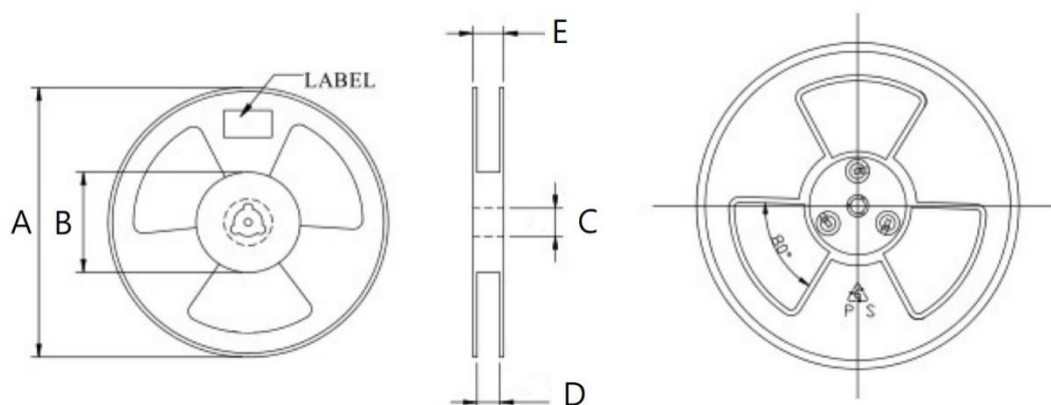

| Type | A(mm) | B(mm) | C(mm) | D(mm) | E(mm) |
|----------|---------|-------|----------|----------|----------|
| 13"X12mm | 330±1.0 | 100±2 | 13.5±0.5 | 12.7±0.5 | 16.7±0.5 |

◆ Packaging Quantity

| Chip Size | 4015 |
|-----------|------|
| 13" Reel | 2500 |

X-ON Electronics

Largest Supplier of Electrical and Electronic Components

Click to view similar products for [Common Mode Chokes / Filters](#) category:

Click to view products by [Sunltech](#) manufacturer:

Other Similar products are found below :

[PE-64683](#) [ST6118T-R](#) [FE3X025-10-7NL](#) [T8114NLT](#) [TCM0806G-350-2P-T](#) [TCM0806G-650-2P-T](#) [IND-0110](#) [UAL21VR0802000](#)
[UALSC023000000](#) [UALSC1020JH000](#) [UALSU10VD20010](#) [UALSU9VD070100](#) [36-00037](#) [CM7060M132R-10](#) [UALW21HS072450](#)
[UALSU9H0208000](#) [UAL24VK06450CH](#) [PLT10HH501100PNB](#) [PLT10HH401100PNB](#) [PLT10HH1026R0PNB](#) [36-00029-01](#) [PE-67531](#)
[TLH10UB](#) [113 0R5](#) [2752045447](#) [CM8663Z161B-10](#) [7351V](#) [CMF16-153131](#) [T8116NLT](#) [CMS2-10-R](#) [FE2X10-4-2NL](#) [T8003NLT](#) [CTX01-](#)
[13663](#) [CTX66-19521-R](#) [RC212-0.5-10M](#) [RC112-0.4-15M](#) [RC212-0.6-6M8](#) [RC212-0.4-15M](#) [RC112-0.3-30M](#) [4534-3](#)
[WTCF2012Z0M751PB](#) [PH9408.814NLT](#) [B82498B3221J000](#) [PAC6006.364NLT](#) [PAC6006.444NLT](#) [PAC6006.204NLT](#) [PH9407.204NLT](#)
[PAC6006.264NLT](#) [PH9408.105NLT](#) [PH9408.494NLT](#) [PAC6006.104NLT](#)