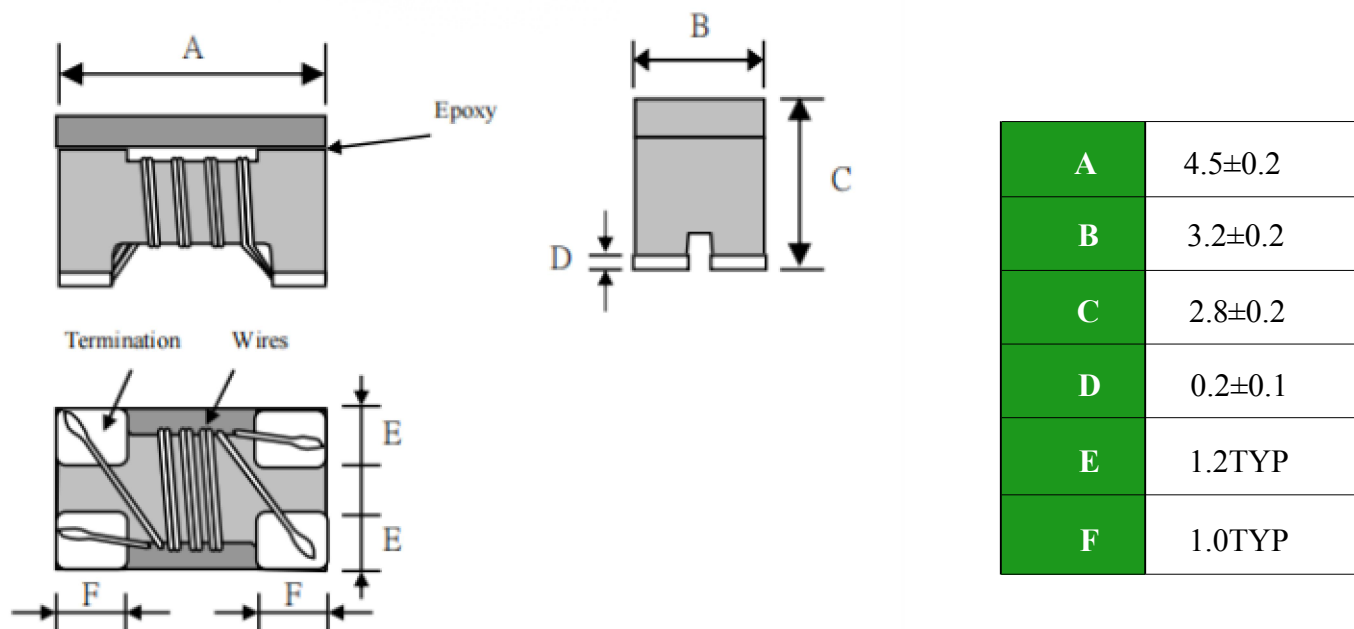
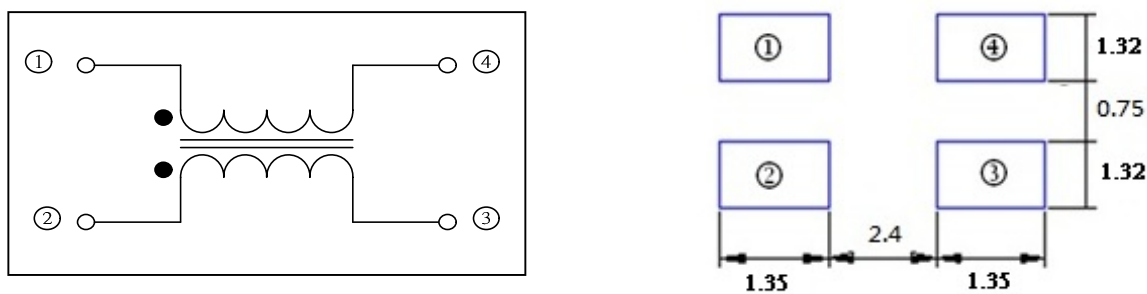
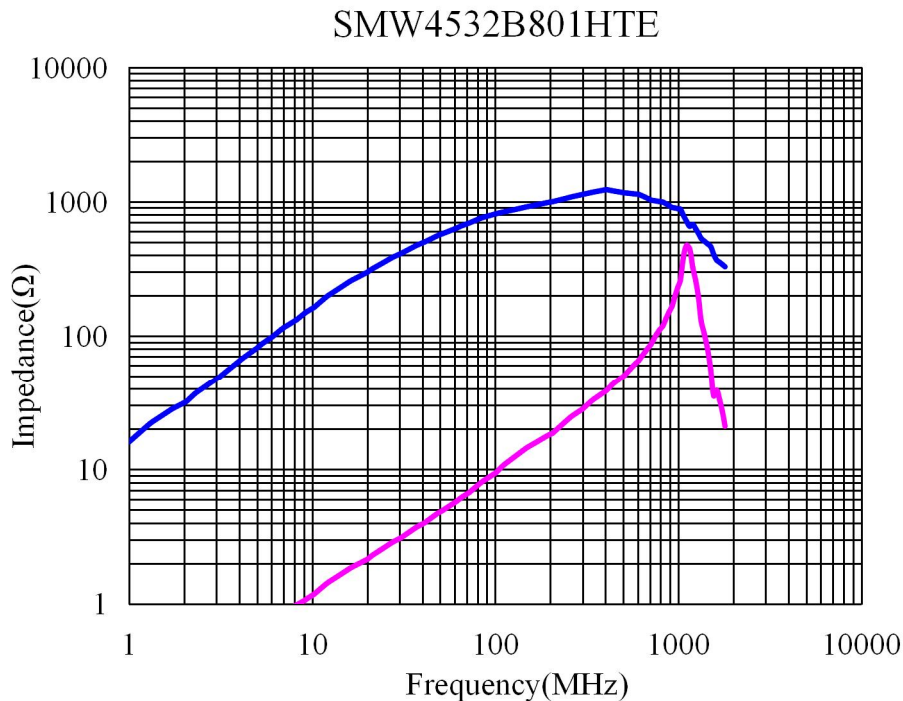

COMMON MODE FILTER
◆ DIMENSIONS:(mm)

◆ RECOMMENDED FOOTPRINT:(mm)

◆ PACKING:
Quantity:500PCS/Reel

◆ ELECTRICAL CHARACTERISTICS:

P/N	Z(Ω)		DCR(Ω)	Rated Current	Rated Voltage	Insulation Resistance
	Common Mode			Idc(A)	Vdc	IR
	Impedance		[Max]			
	At 100MHz		[Max]			
SMW4532B801HTE	800		0.12	1.0	50.0	10.0

- Operating temperature:-25°C to +85°C
Storage temp and humidity:-40°C to +85°C 70%RH max
Typical heat rating DC current would cause an approximately ΔT of 40°C

◆ PERFORMANCE CURVES:

◆ Test Equipment

Impedance

Measured by using Agilent 4291A RF Impedance Analyzer

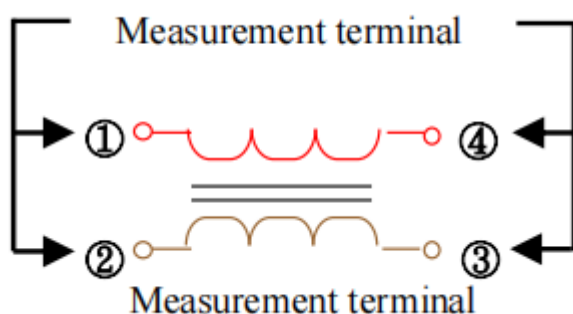

DC Resistance

Measured by using Chroma 16502 mill ohm meter

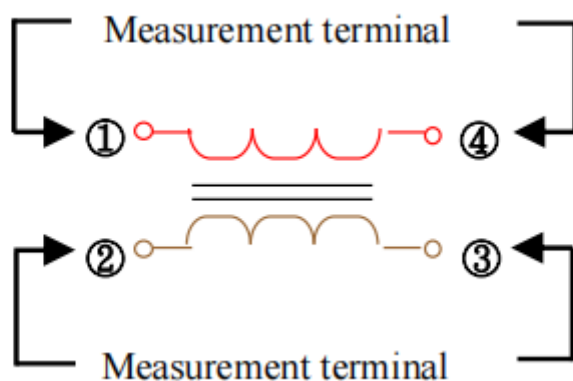

Insulation Resistance

Measured by using Chroma 19073

Measurement voltage:50V Measurement time:60 sec

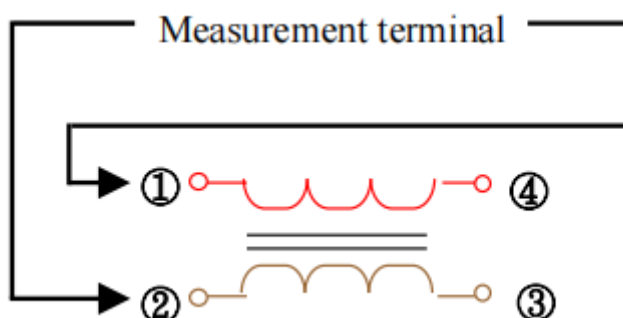

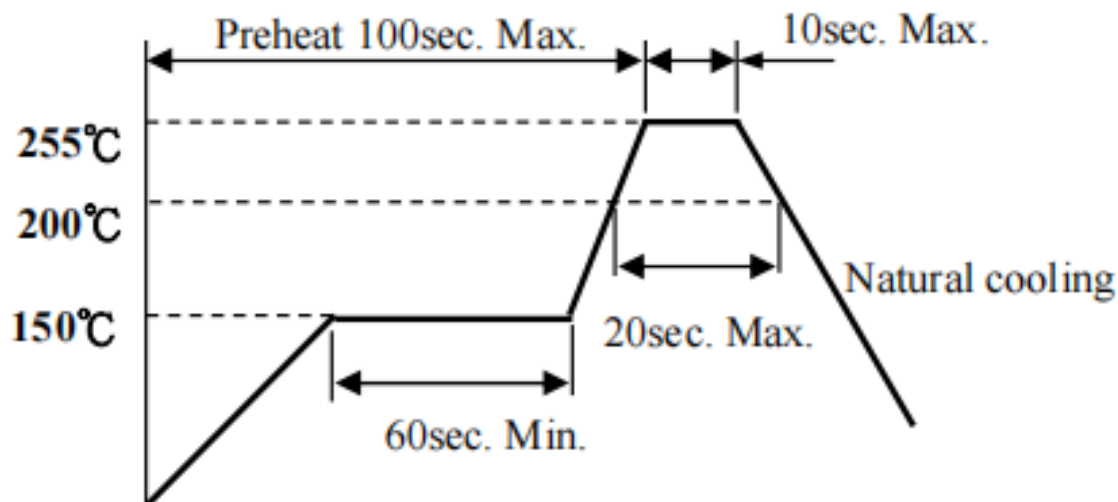
◆ RECOMMENDED SOLDERING TEMP CRAPH:

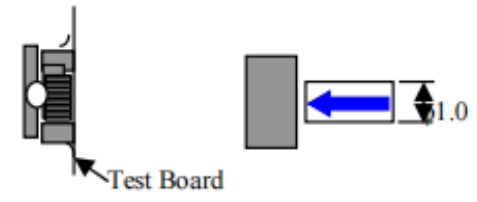
◆ MECHANICAL RELIABILITY:

TEST	Specification & Requirement		Method Used
Solderability	The surface of terminal/pin tested shall be covered with new solder by 90%		Solder heat proof Preheating: 150 ±10°C 60 seconds Soldering: 245 ±5°C for 4 ±1 sec
Solder Heat Resistance	Components should have not evidence of electrical and mechanical damage Impedance: within ±15% of initial value		Preheating: 150°C 60secs Solder temperature: 260±5°C Flux: rosin Dip time: 10±0.5 secs
Terminal strength	Series No	F (Kg)	Solder a chip to test substrate and then laterally apply a force in the arrow direction 
	1608	0.5	
	2012	0.5	
	3216	1.0	
	4532	1.0	

◆ ENDURANCE RELIABILITY:

TEST	Specification & Requirement	Method Used
Thermal Shock	Impedance change within $\pm 15\%$ Without mechanical damage	-65°C, (30 mins) -> room temp. (2 mins) -> 125°C, (30 mins) -> room temp. (2 mins) 50 cycles
Humidity Resistance	Impedance change within $\pm 15\%$ Without mechanical damage	Apply IDC current @ 60°C ambient Humidity: 90% Duration: 168 hrs
Low Temp. Storing	Impedance change within $\pm 15\%$ Without mechanical damage	Storing Temp. -40 ± 2 °C for total 168 +5/-0 hours
High Temp. Storing	Impedance change within $\pm 15\%$ Without mechanical damage	Storing Temp. 125 ± 2 °C for total 168 +5/-0 hours

X-ON Electronics

Largest Supplier of Electrical and Electronic Components

Click to view similar products for [Common Mode Chokes / Filters](#) category:

Click to view products by [Sunltech](#) manufacturer:

Other Similar products are found below :

[PE-64683](#) [RD5122-6-9M6](#) [RD6137-6-7M5](#) [RD8147-16-3M0](#) [ST6118T-R](#) [FE3X025-10-7NL](#) [RD7147-25-0M7](#) [TCM0806G-350-2P-T](#)
[TCM0806G-650-2P-T](#) [IND-0110](#) [UAL21VR0802000](#) [UALSC023000000](#) [UALSC1020JH000](#) [UALSU10VD20010](#) [UALSU9VD070100](#) [36-00037](#) [UALW21HS072450](#) [UALSU9H0208000](#) [UAL24VK06450CH](#) [PLT10HH501100PNB](#) [PLT10HH401100PNB](#) [PLT10HH1026R0PNB](#)
[36-00029-01](#) [PE-67531](#) [TLH10UB](#) [113 0R5](#) [2752045447](#) [7351V](#) [CMF16-153131](#) [RD7147-6-6M0](#) [T8116NLT](#) [FE2X10-4-2NL](#) [36-00029-07](#)
[T8003NLT](#) [CTX01-13663](#) [CTX66-19521-R](#) [RC212-0.5-10M](#) [RC112-0.4-15M](#) [RC212-0.6-6M8](#) [RC212-0.4-15M](#) [RC112-0.3-30M](#)
[WTCF2012Z0M751PB](#) [PH9408.814NLT](#) [PAC6006.364NLT](#) [PAC6006.444NLT](#) [PAC6006.204NLT](#) [PH9407.204NLT](#) [PAC6006.264NLT](#)
[PH9408.105NLT](#) [PH9408.494NLT](#) [PAC6006.104NLT](#)