

Common Mode Chokes

◆ Features:

1. Chip-type common mode filter for large current applications
2. Ideal for noise suppressed
3. Smaller size and low profile
4. Operating Temp: $-40^{\circ}\text{C} \sim +105^{\circ}\text{C}$

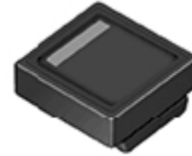

◆ Applications:

Used for power line noise suppression for any electronic devices

◆ Dimensions:

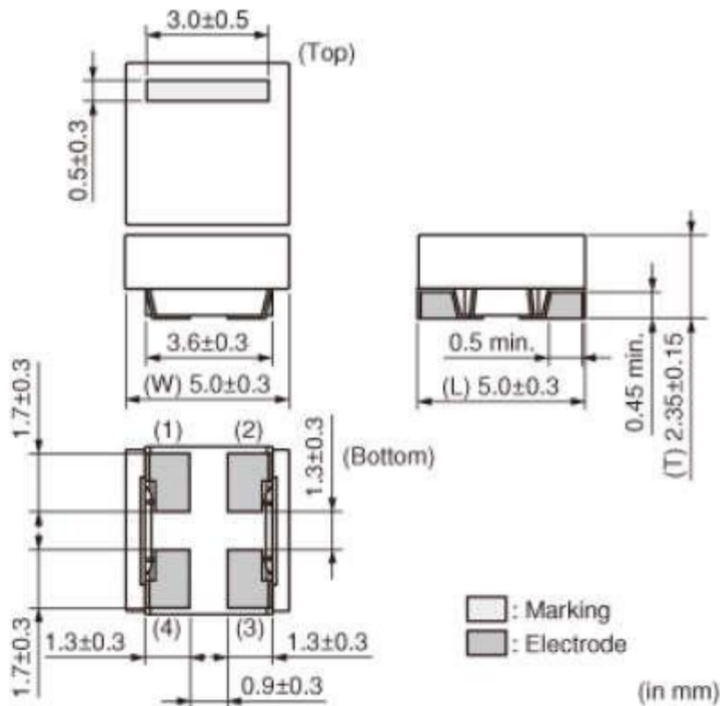

◆ Schematic Diagram:

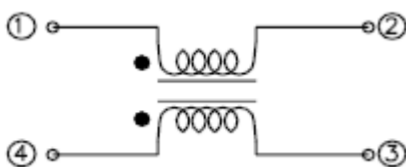

◆ Packing: 2500pcs/Reel

◆ Specifications:

Part No	Impedance(Ω)		RDC(m Ω) Max(1 line)	Rated Current (A)Max	IR(m Ω) Min	Rated Voltage (V)Max
	@10MHz	@100MHz				
	Min	Typ				
SMW5025S101QTT	10	100	13	6.0	10	100
SMW5025S251PTT	20	250	20	5.0	10	50
SMW5025S501NTT	30	500	27	4.0	10	50
SMW5025S102MTT	60	1000	34	2.0	10	50
SMW5025S142LTT	100	1400	56	1.5	10	50

◆ Typical Electrical Characteristics:

SMW5025S101QTT

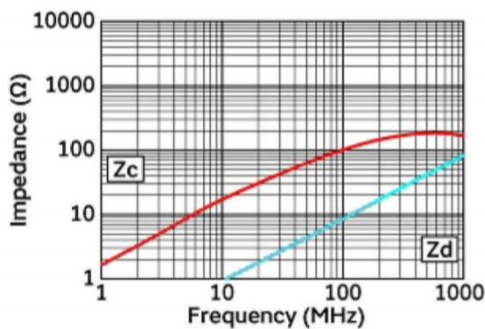

SMW5025S251PTT

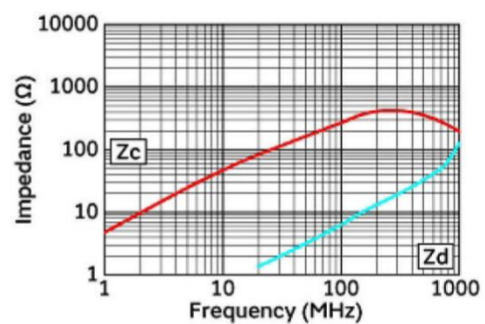

SMW5025S501NTT

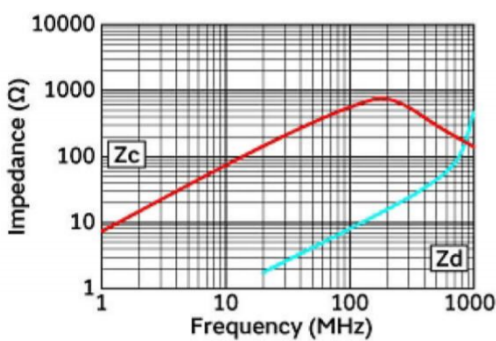

SMW5025S102MTT

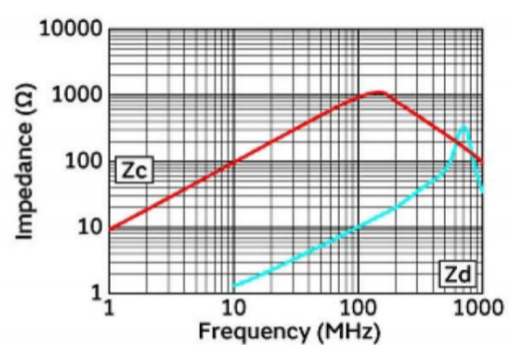

SMW5025S142LTT

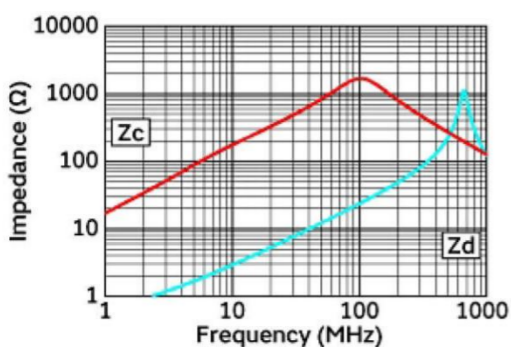

X-ON Electronics

Largest Supplier of Electrical and Electronic Components

Click to view similar products for [Common Mode Chokes / Filters](#) category:

Click to view products by [Sunltech](#) manufacturer:

Other Similar products are found below :

[PE-64683](#) [RD5122-6-9M6](#) [RD6137-6-7M5](#) [RD8147-16-3M0](#) [ST6118T-R](#) [FE3X025-10-7NL](#) [RD7147-25-0M7](#) [TCM0806G-350-2P-T](#)
[TCM0806G-650-2P-T](#) [IND-0110](#) [UAL21VR0802000](#) [UALSC023000000](#) [UALSC1020JH000](#) [UALSU10VD20010](#) [UALSU9VD070100](#) [36-00037](#) [UALW21HS072450](#) [UALSU9H0208000](#) [UAL24VK06450CH](#) [PLT10HH501100PNB](#) [PLT10HH401100PNB](#) [PLT10HH1026R0PNB](#)
[36-00029-01](#) [PE-67531](#) [TLH10UB](#) [113 0R5](#) [2752045447](#) [7351V](#) [CMF16-153131](#) [RD7147-6-6M0](#) [T8116NLT](#) [FE2X10-4-2NL](#) [36-00029-07](#)
[T8003NLT](#) [CTX01-13663](#) [CTX66-19521-R](#) [RC212-0.5-10M](#) [RC112-0.4-15M](#) [RC212-0.6-6M8](#) [RC212-0.4-15M](#) [RC112-0.3-30M](#)
[WTCF2012Z0M751PB](#) [PH9408.814NLT](#) [PAC6006.364NLT](#) [PAC6006.444NLT](#) [PAC6006.204NLT](#) [PH9407.204NLT](#) [PAC6006.264NLT](#)
[PH9408.105NLT](#) [PH9408.494NLT](#) [PAC6006.104NLT](#)