

Features:

- ◆ 1: 1.33 Impedance
- ◆ 75Ω Characteristic Impedance
- ◆ Frequency: 4 to 2800 MHz
- ◆ RF power: 0.25W
- ◆ DC current: 30mA
- ◆ Operating temperature range: -40°C to +85°C
- ◆ Storage temperature range: -55°C to +100°C



Applications:

- ◆ For broadband and wireless communications
- ◆ For VHF/UHF receivers/transmitters and push-pull amplifiers

Dimension Diagram (Unit:mm) :

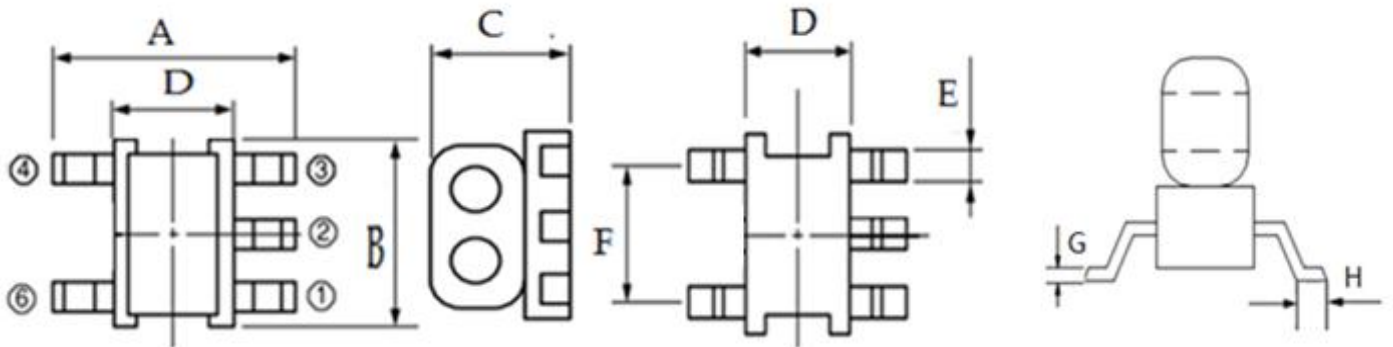

A=4.10±0.20 B=3.80±0.20 C=3.20±0.20 D=2.80±0.20 E=0.55±0.05 F=2.54±0.05 G=0.25±0.05 H=0.60±0.05

Electrical structure:

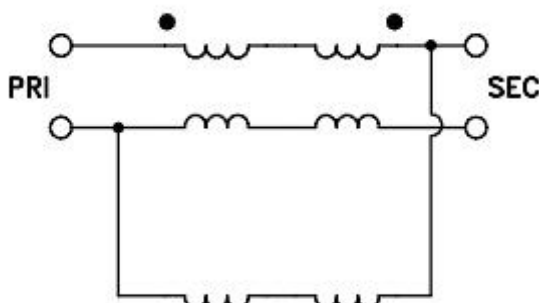

Recommended layout:

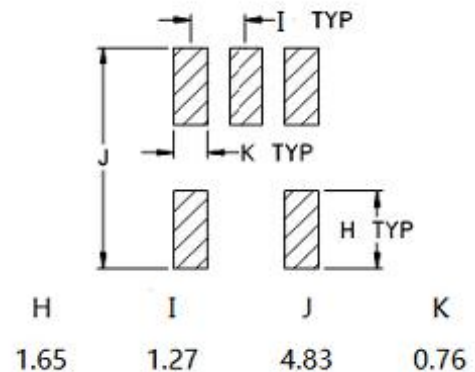

Pin configuration

1	SECONDARY
2	NOT USED
3	SECONDARY DOT
4	PRIMARY
6	PRIMARY DOT

Application circuit :

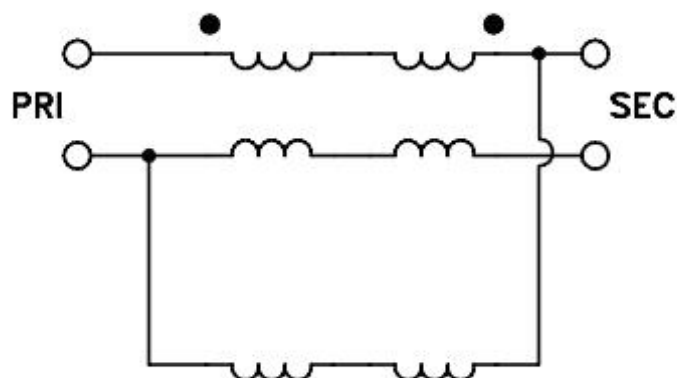

Electrical Specifications at 25°C, 75Ω

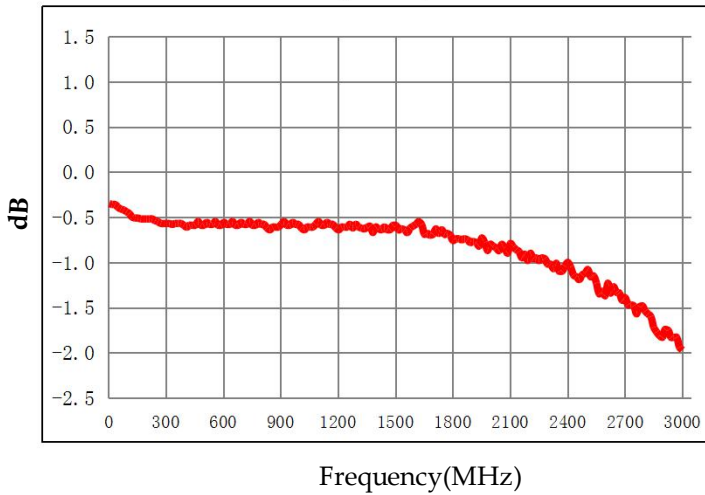
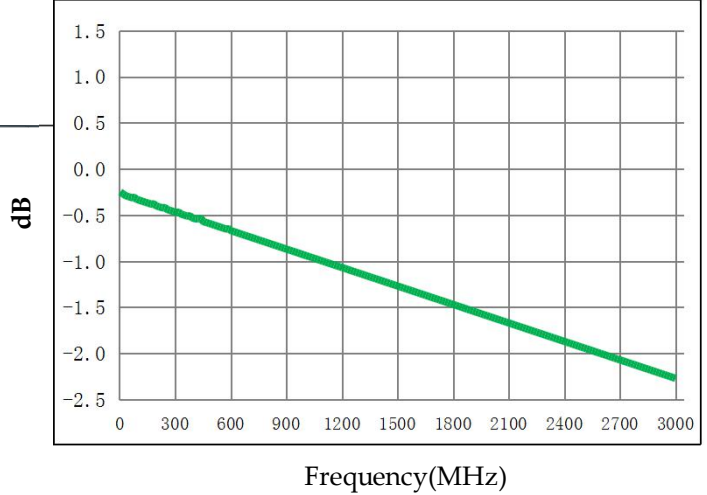
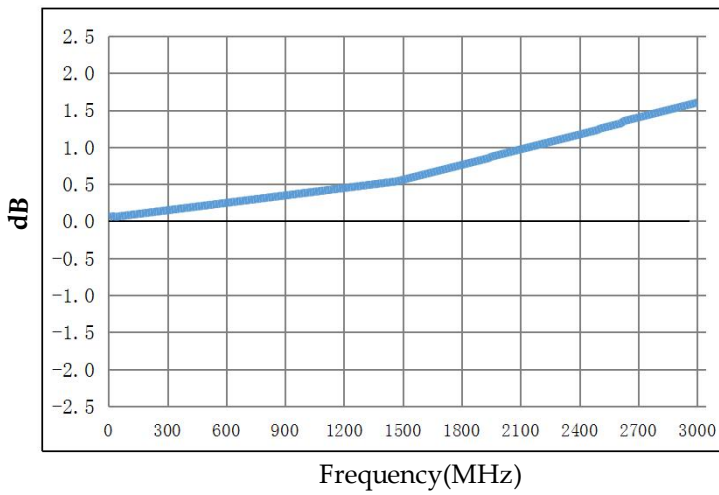
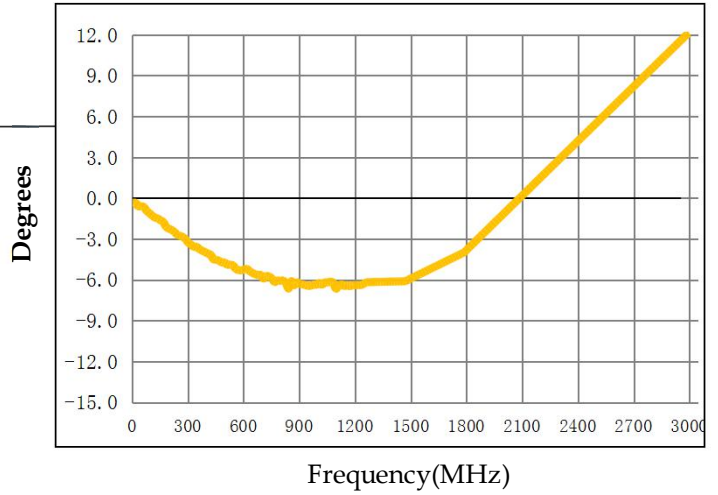
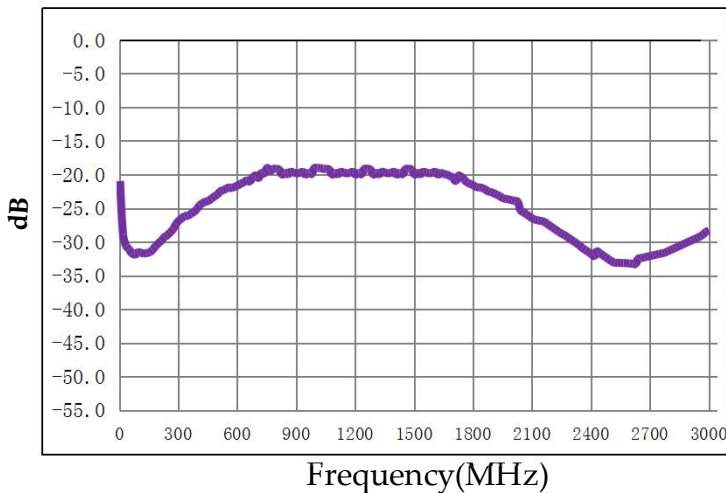
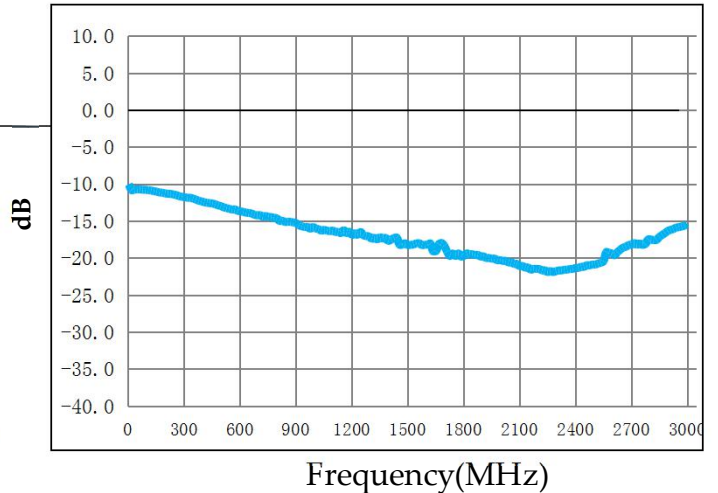
Parameter	Test Conditions	Units	Min	Typ	Max
Main line Loss(out1)	4-2800MHz	dB	—	0.5	3.0
Main line Loss(out2)	4-2800MHz	dB	—	1.0	3.5
Amplitude Balance	4-2800MHz	dB	—	0.8	±2.0
Phase Balance	4-2800MHz	Degrees	—	6.0	±10.0
Input Return Loss	4-2800MHz	dB	10.0	20.0	—

Main line Loss(out1)

Main line Loss(out2)

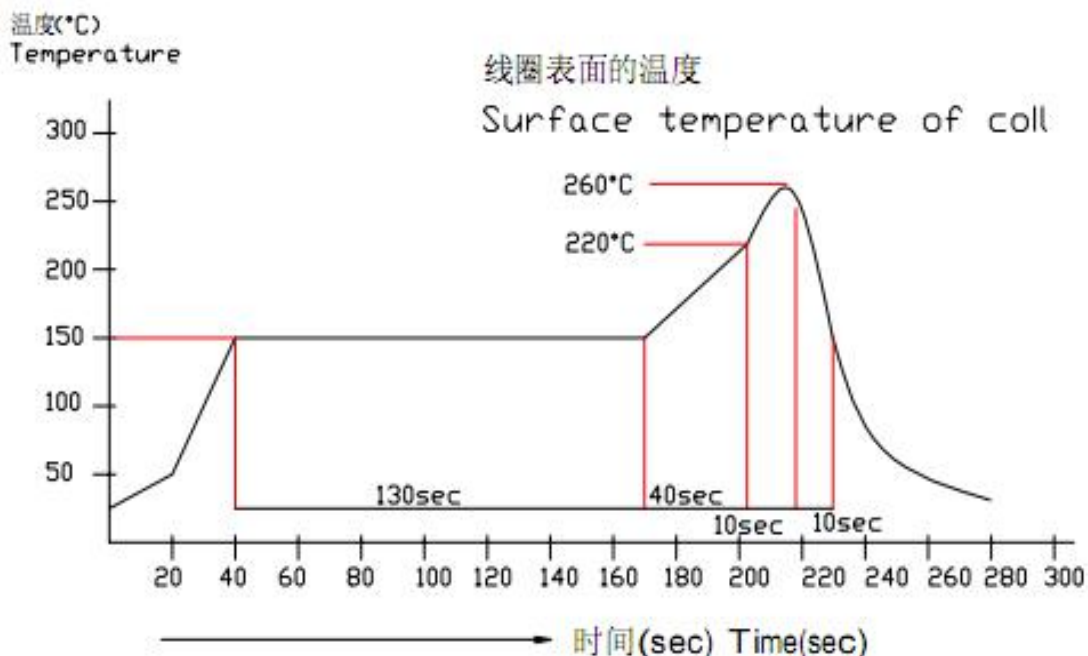
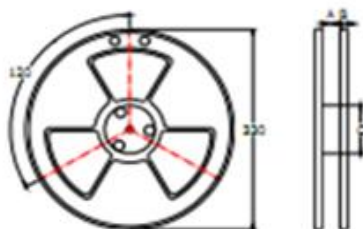
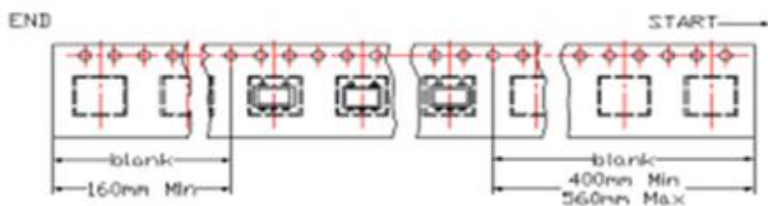
Amplitude Balance

Phase Balance

Input Return Loss

Sdd22

Recommended Soldering Temperature Graph:

建议迴焊条件
The condltion of reflow
(Recommendation)

Packging Dimension For Caeer Tape(UNIT:mm):

SPEC	8	12	16	24	32	44	56	72
DIM A±0.1	8.5	12.5	16.5	24.5	32.5	44.5	56.5	72.5
DIM B±0.1	2.3	2.3	2.3	2.3	2.3	2.3	2.3	2.3
DIM Ct±0.1	100	100	100	100	100	100	100	100

QUANTITY
2000PCS/Reel

15 reel/Big carton/60000pcs

X-ON Electronics

Largest Supplier of Electrical and Electronic Components

Click to view similar products for [Signal Conditioning](#) category:

Click to view products by [Sunltech](#) manufacturer:

Other Similar products are found below :

[PD0409J5050S2HF](#) [HHS-109-PIN](#) [AFS14A35-1591.50-T3](#) [JP510S](#) [LFB322G45SN1A504](#) [SF2159E](#) [FM-104-PIN](#) [CER0813B](#)

[MAPDCC0005](#) [3A325](#) [BD0810N50100AHF](#) [DC0710J5005AHF](#) [DC2327J5005AHF](#) [LFL15869MTC1B787](#) [X3C19F1-20S](#)

[CDBLB455KCAX39-B0](#) [RF1353C](#) [051157-0000](#) [PD0922J5050D2HF](#) [600S150FTRB](#) [1E1305-3](#) [1F1304-3S](#) [TP-103-PIN](#)

[BD1222J50200AHF](#) [BD1722J50100AHF](#) [2450DP39K5400E](#) [BD0810J50150AHF](#) [BD1722J50200AHF](#) [DS-327-PIN](#) [MACP-008125-](#)

[CK07F0](#) [DS-329-PIN](#) [DS-313-PIN](#) [TP-104-PIN](#) [TP-101-PIN](#) [HH-128-PIN](#) [8594810000](#) [T-1000-N](#) [JP506S](#) [XC0900P-10S](#) [XC0900B-30S](#)

[CHE1260-QAG](#) [11305-10](#) [5962-9091202MXA](#) [3A412S](#) [X3C06A4-03S](#) [B39000Z3410A4](#) [DSS-333-PIN](#) [PD2425J5050S2HF](#)

[B39242B4360P810](#) [B39781B8005P810](#)