

VOLTAGE RANGE: 40 - 200V

CURRENT: 10 A

Features

- High efficiency operation
- Low power loss
- Low stored charge majority carrier conduction
- High forward surge capability
- Lead free in compliance with EU RoHS 2011/65/EU directive
- Green molding compound as per IEC61249 Std..(Halogen Free)

Mechanical Data

- Circuit figure: Common cathode
- Leads: Solderable per mil-std-202, Method 208
- Polarity: as marked
- Mounting torque: 5 in-lbs maximum
- Terminals: Puretin plated
- Weight: TO-220AB 1.85 grams

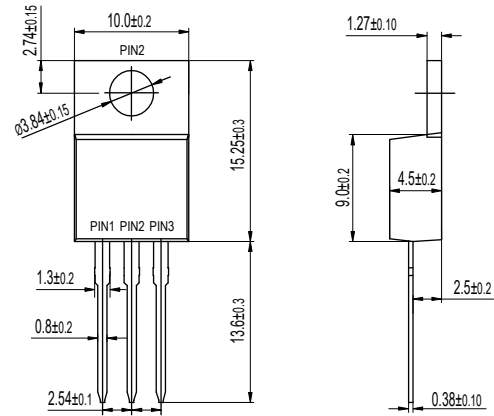
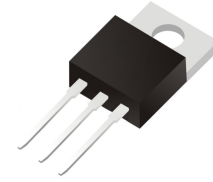

TO-220AB

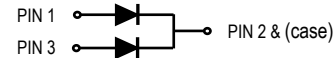

Maximum Ratings and Electrical Characteristics $T_A = 25^\circ\text{C}$ unless otherwise specified

RATINGS	SYMBOL	MBR 1040CT	MBR 1045CT	MBR 1060CT	MBR 10100CT	MBR 10150CT	MBR 10200CT	UNIT	
Maximum repetitive reverse voltage	VRRM	40	45	60	100	150	200	V	
Maximum RMS voltage	VRMS	28	32	42	70	105	140	V	
Maximum DC blocking voltage	VDC	40	45	60	100	150	200	V	
Maximum average forward current per device per diode	I _{AV}	10							A
		5							
Peak forward surge current, 8.3ms single half sine-wave superimposed on rated load	I _{FSM}	125							A
Typical thermal resistance (Note 1)	R _{θ-JC}	2.0							°C/W
Operating junction temperature range	T _J	-55 to +150				-55 to +175		°C	
Storage temperature range	T _{STG}	-55 to +175						°C	
Maximum forward voltage per leg at I _F =5A	V _F	0.65		0.75	0.85		0.92	V	
Maximum average reverse current at rated DC blocking voltage	I _R		0.10				0.01	mA	
			15				5		

Notes: 1. Thermal resistance from junction to case.

FIG. 1 - TYPICAL FORWARD CURRENT DERATING CURVE

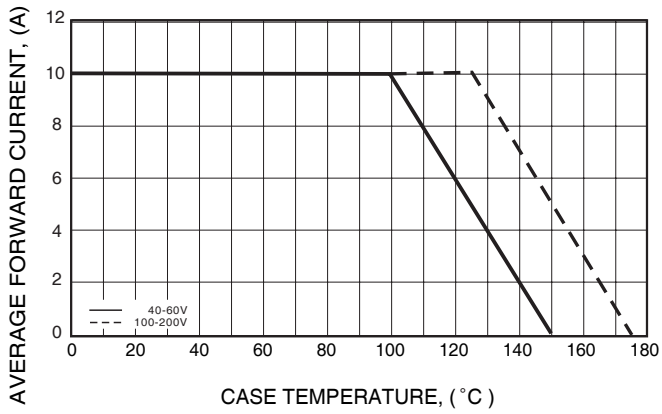

FIG. 2 - MAXIMUM NON-REPETITIVE FORWARD SURGE CURRENT

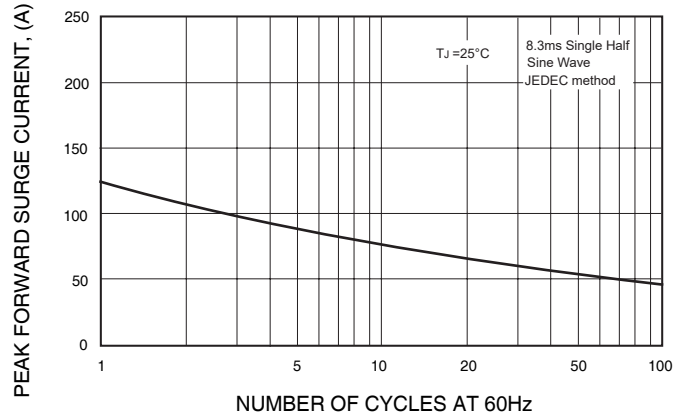

FIG. 3 - TYPICAL REVERSE CHARACTERISTICS

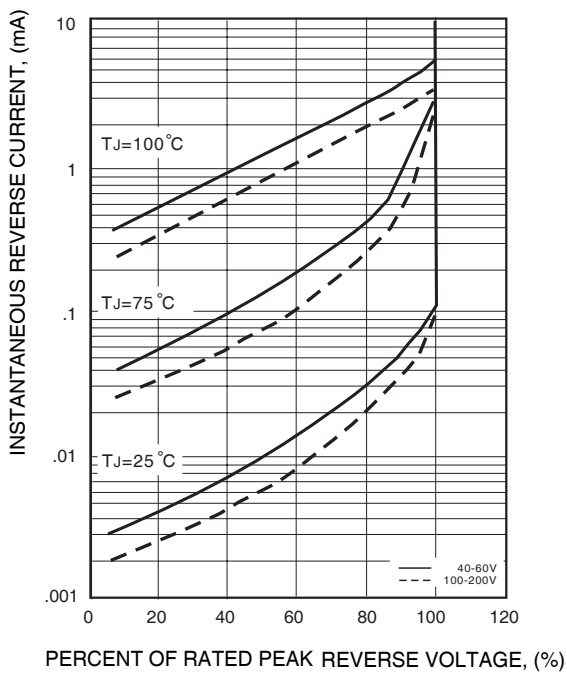
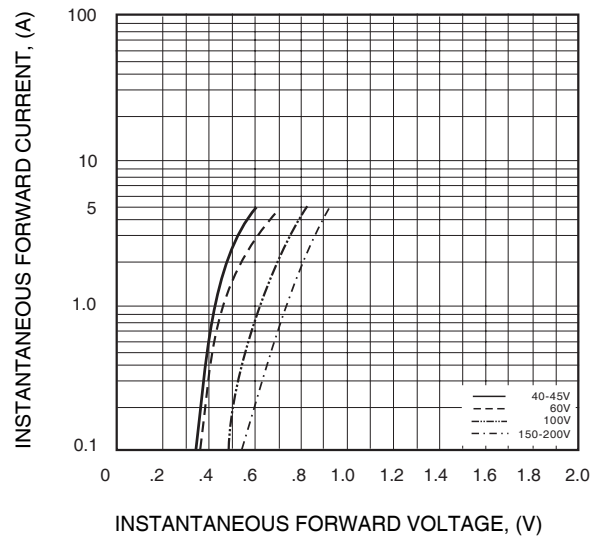

FIG. 4 - TYPICAL INSTANTANEOUS FORWARD CHARACTERISTICS



X-ON Electronics

Largest Supplier of Electrical and Electronic Components

Click to view similar products for [Schottky Diodes & Rectifiers](#) category:

Click to view products by [SUNMATE](#) manufacturer:

Other Similar products are found below :

[MA4E2039](#) [MMBD301M3T5G](#) [RB160M-50TR](#) [D83C](#) [BAS16E6433HTMA1](#) [BAS 3010S-02LRH E6327](#) [BAT 54-02LRH E6327](#)
[NRVBAF360T3G](#) [NSR05F40QNXT5G](#) [NTE555](#) [JANS1N6640](#) [SS3003CH-TL-E](#) [GA01SHT18](#) [CRS10I30A\(TE85L,QM](#) [MBRA140TRPBF](#)
[MBRB30H30CT-1G](#) [BAT 15-04R E6152](#) [JANTX1N5712-1](#) [DMJ3940-000](#) [SB007-03C-TB-E](#) [NRVBB20100CTT4G](#) [NRVBM120LT1G](#)
[NTSB30U100CT-1G](#) [CRG04\(T5L,TEMQ\)](#) [ACDBA1100LR-HF](#) [ACDBA1200-HF](#) [ACDBA240-HF](#) [ACDBA3100-HF](#) [CDBQC0530L-HF](#)
[ACDBA260LR-HF](#) [ACDBA1100-HF](#) [10BQ015-M3/5BT](#) [NRVBM120ET1G](#) [VSSB410S-M3/5BT](#) [1N5819T-G](#) [PDS1040Q-13](#) [B160BQ-13-F](#)
[SDM05U20CSP-7](#) [BAS 70-07 E6433](#) [B140S1F-7](#) [HSM560Je3/TR13](#) [DDB2265-000](#) [ZHCS506QTA](#) [HSM190Je3/TR13](#) [B330AF-13](#)
[ACDBUC0230-HF](#) [SDM1U100S1F-7](#) [MBR10200CTF-G1](#) [CDLL5712](#) [DMF2822-000](#)