



---

# SK3410R120

Band41, RF-Rx SAW Filter  
Revision 0: August 2017

MSL 3 Device



- Electrical Characteristics
  - Package Dimensions
  - Testing Environment
  - Frequency Characteristics
-

## □ Electrical Characteristics

### Maximum Ratings

Parameters Description	Unit	Minimum	Typical	Maximum
Operating Temperature Range	°C	-30	-	+85
Storage Temperature Range	°C	-40	-	+85
Maximum DC Voltage	V	-	-	-
Maximum Input Power	dBm	-	-	15
Source Impedance (unbalanced) <sup>(1)</sup>	Ω	-	50	-
Load Impedance (unbalanced) <sup>(1)</sup>	Ω	-	50	-
Package type & size	C14			
Length x Width	mm <sup>2</sup>	-	1.1 x 0.9	-
Height	mm	-	-	0.65

### Electrical Specification

Parameters Description	Unit	Minimum	Typical	Maximum
Center Frequency (Fo)	MHz	-	2595.0	-
Insertion Loss within 2535.0 ~ 2655.0 MHz	dB	-	1.6	2.8
Amplitude Ripple within 2535.0 ~ 2655.0 MHz	dB <sub>p-p</sub>	-	0.5	2.0
<b>Attenuation:</b>				
2110.0 ~ 2170.0 MHz	dB	18	21	-
2401.0 ~ 2468.0 MHz (WLAN Ch 1~10)	dB	23	26	-
2451.0 ~ 2473.0 MHz (WLAN Ch 11)	dB	25	30	-
2456.0 ~ 2478.0 MHz (WLAN Ch 12)	dB	25	30	-
2461.0 ~ 2483.0 MHz (WLAN Ch 13)	dB	25	29	-
2775.0 ~ 4992.0 MHz	dB	18	22	-
VSWR within 2535.0 ~ 2655.0 MHz	-	-	2.1	2.5

**Notes :** (1) With Matching Network (Ref. Testing Environment Circuit as shown below).

## Package Dimensions

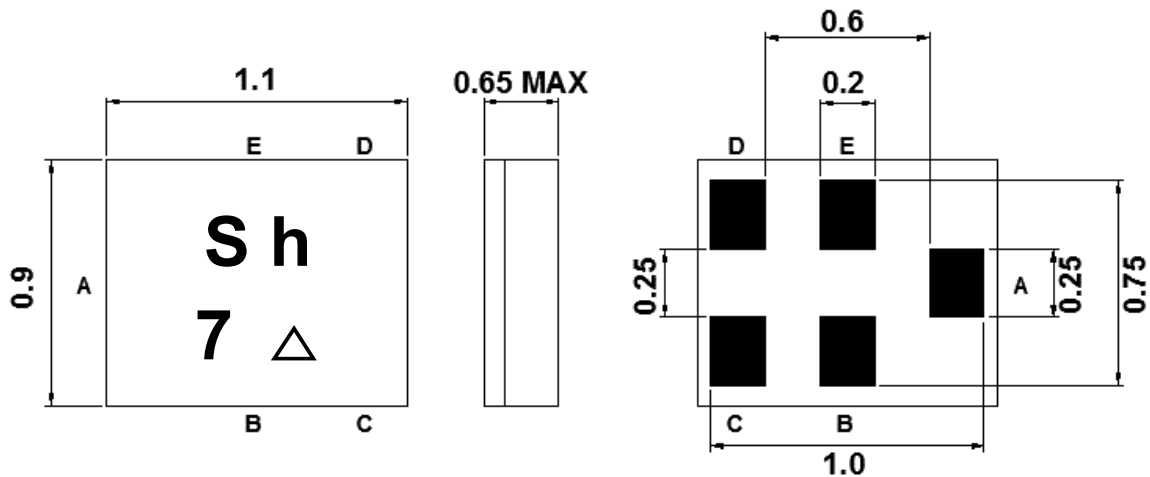

Marking Descriptions	
S	SUNTEK
h	Band Class
7	Series Number
△	Date Code(Year+Month)

Pin Description	
B, C, E	Ground
A	Input
D	Output

## Testing Environment

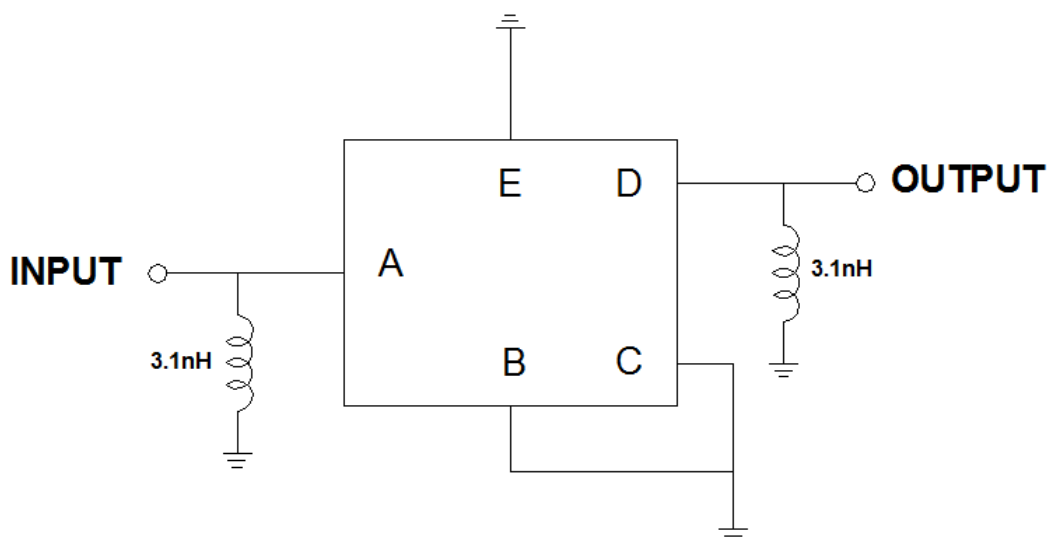

Source & Load Impedance: 50  $\Omega$

## □ Frequency Characteristics

Frequency Response

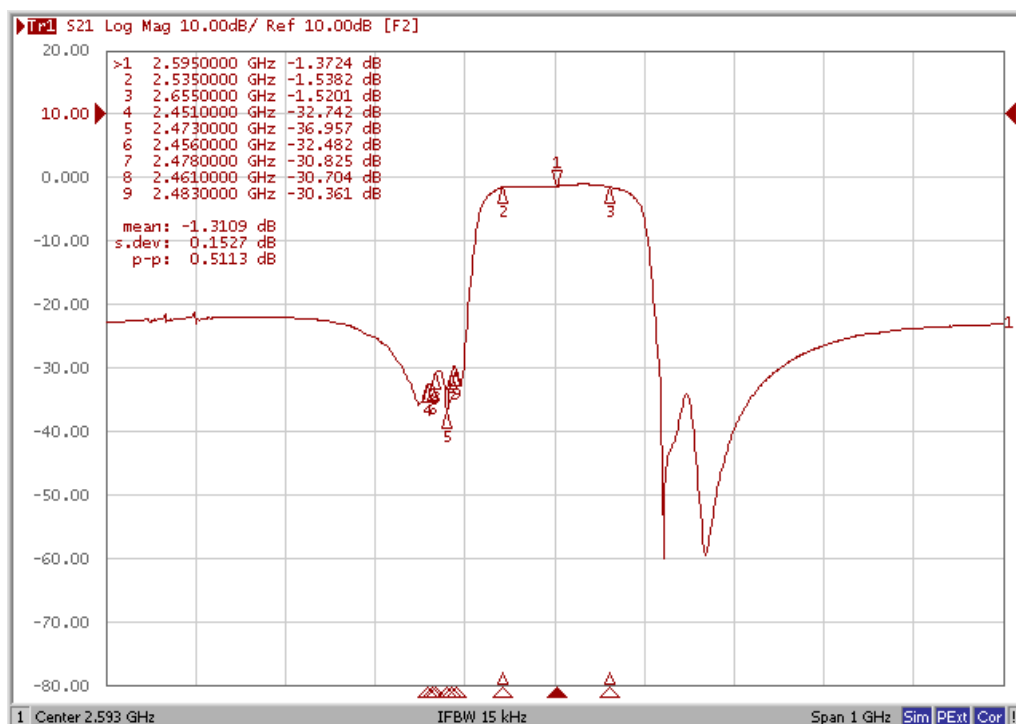

### VSWR

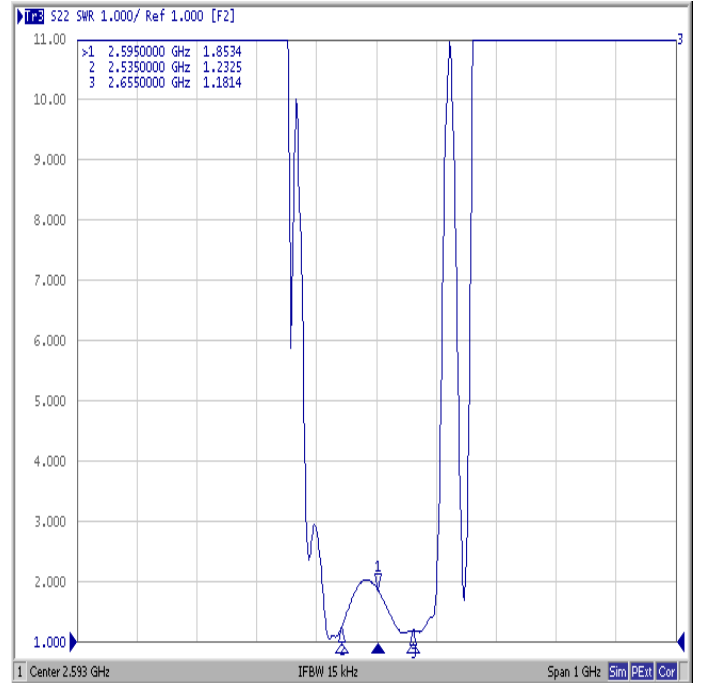
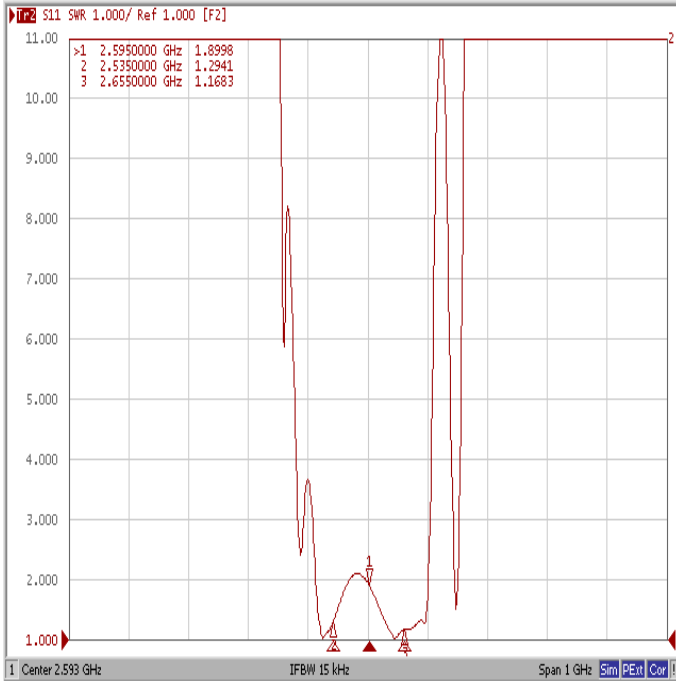

### Smith Chart

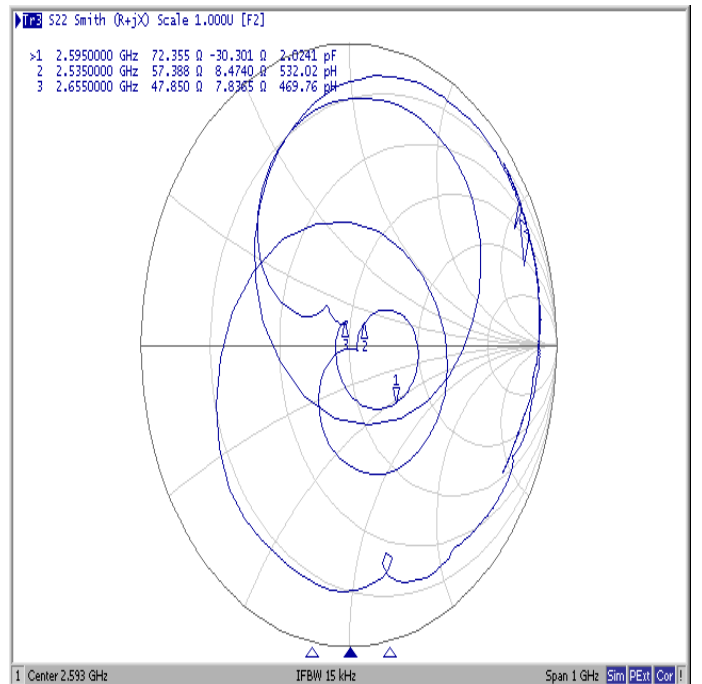
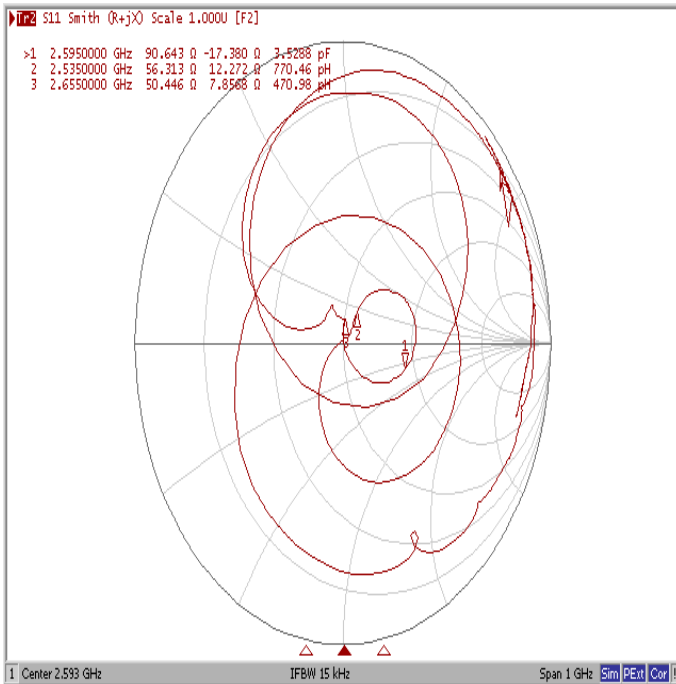

## X-ON Electronics

Largest Supplier of Electrical and Electronic Components

*Click to view similar products for [Signal Conditioning](#) category:*

*Click to view products by [Suntek](#) manufacturer:*

Other Similar products are found below :

[MAPDCC0001](#) [MAPDCC0004](#) [PD0409J5050S2HF](#) [HHS-109-PIN](#) [AFS14A30-2185.00-T3](#) [AFS14A35-1591.50-T3](#) [DS-323-PIN](#) [DSS-313-PIN](#) [B39321R801H210](#) [1A0220-3](#) [JP510S](#) [LFB212G45SG8C341](#) [LFB322G45SN1A504](#) [LFL182G45TC3B746](#) [SF2159E](#) [30057](#)  
[AFS1575.42S4-T](#) [FM-104-PIN](#) [CER0813B](#) [MAPDCC0005](#) [3A325](#) [40287](#) [41180](#) [ATB3225-75032NCT](#) [BD0810N50100AHF](#) [JHS-115-PIN](#)  
[DC0710J5005AHF](#) [DC2327J5005AHF](#) [43020](#) [LFB2H2G60BB1C106](#) [LFL15869MTC1B787](#) [X3C19F1-20S](#) [XC3500P-20S](#) [10013-20](#)  
[SF2194E](#) [CDBLB455KCAX39-B0](#) [TGL2208-SM, EVAL](#) [RF1353C](#) [051157-0000](#) [PD0922J5050D2HF](#) [1E1305-3](#) [1F1304-3S](#) [1G1304-30](#)  
[B0922J7575AHF](#) [10017-3](#) [TP-103-PIN](#) [BD1222J50200AHF](#) [BD1722J50100AHF](#) [2450DP39K5400E](#) [BD0810J50150AHF](#)