

# SK3700S\_H

MSL 3 Device

WI-FI, RF-Rx SAW Filter Revision  
0 : April 2020



- Description
- Key Applications
- Features
- Package & Dimensions:
- Matching Circuit
- Absolute Maximum Ratings
- Electrical Specifications
- Transmission coefficient
- Reflection coefficients
- Packing material
- Recommended Soldering Profile
- Important Notice

## 1 Description

SK3700S\_H is a high-performance Surface Acoustic Wave (SAW) Bandpass filter optimized for co-existence between cellular 4G/LTE-TDD Band B40, B41, LTE-FDD Band B7, and Wi-Fi/Bluetooth applications operating in the range of 2.4-2.5 GHz license-free ISM band. It is designed to provide both low insertion loss in the Wi-Fi/BT Band and high rejection in the cellular Bands, in order to enable simultaneous operation of Wi-Fi/BT and 4G/LTE within the same device, such as smartphones.

SK3700S\_H uses advanced Chip Scale Package (CSP) technology and is housed in an industry-standard, 5-pin 1.1mmx0.9mm package with a low profile of 0.6mm max.

## 2 Key Applications

- Smartphones
- Wi-Fi APs, Routers, Home Gateways
- Portable Hotspots
- Smart Meters
- Bluetooth/BLE Devices
- IoT Devices in 2.4-2.5GHz ISM Band

## 3 Features

- Low Insertion Loss: 1.9dB at Mid-Band
- High Rejection in B40/B41/B7
- Small Footprint:  $0.325 \pm 0.03\text{mm} \times 0.25 \pm 0.03\text{mm}$ .
- Package size  $1.1 \pm 0.05\text{mm} \times 0.9 \pm 0.05\text{mm}$
- Electrostatic Sensitive Device(ESD)
- Package height 0.6mm max.
- Single-Ended Operation
- RoHS Compliant

## 4 Package & Dimensions:

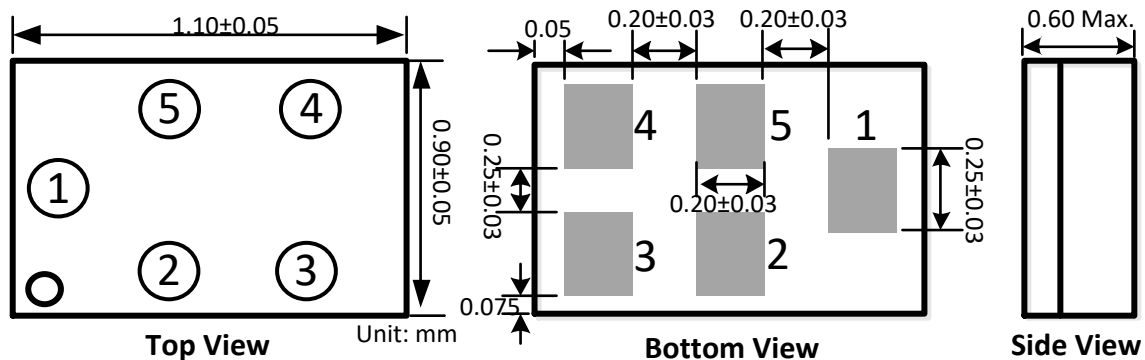

Figure 1: Drawing of Package with each tolerance range

## 5 Pin configuration

- 1 Input (recommended)
- 4 Output (recommended)
- 2,3,5 To be grounded

## 6 Matching Circuit

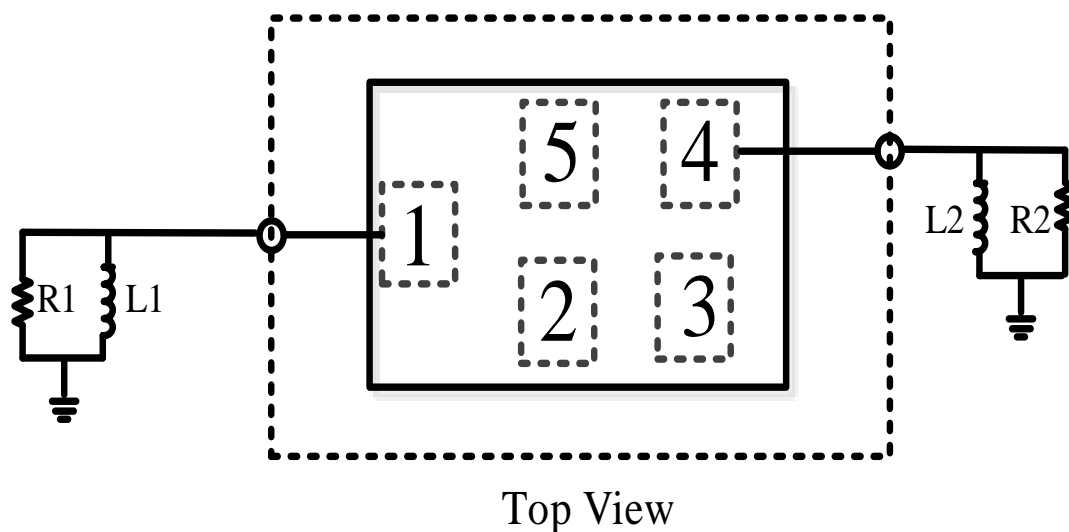

Figure 2: Schematic of matching circuit. No external matching components required.

R1: 50 Ohm	L1: NC
R2: 50 Ohm	L2: NC

## 7 Absolute Maximum Ratings

Parameter	Rating	Unit
Operating Temperature	-35 to +85	°C
Storage Temperature	-40 to +85	°C
Maximum Input Power	+28	dBm
Maximum DC Voltage	5	V
Input terminating impedance	50	Ω
Output terminating impedance	50	Ω
Input Power@input port	P <sub>in</sub> =20dBm Continuous wave for 2000h@55° C	

1) Not valid for packaging material. Storage temperature for packaging material is -25° C to +40° C.

2) In case of applied DC voltage blocking capacitors are mandatory

## 8 Electrical Specifications

(At  $T_a=25^{\circ}\text{C}$ , unless otherwise specified, as measured on the evaluation board of SK3700S\_H with feed line loss de-embedded.)

Parameter	Conditions	Min	Typ.	Max	Unit
Insertion Loss	2403 - 2471 MHz	-	1.9	2.5	dB
	2458 - 2476 MHz	-	1.8	2.4	dB
	2463 - 2481 MHz	-	2.2	2.8	dB
Passband Ripple	2403 - 2481 MHz	-	1.2	1.6	dB
Attenuation	800 - 2300 MHz	25	29	-	dB
	2300 - 2370 MHz	29	35	-	dB
	2370 - 2380 MHz	10	15	-	dB
	2510 - 2570 MHz	36	41	-	dB
	2570 - 2620 MHz	30	33	-	dB
	2620 - 2690 MHz	30	32	-	dB
VSWR Input	2403 - 2481 MHz	-	1.7	2.0	-
VSWR Output	2403 - 2481 MHz	-	1.7	2.0	-

## 9 Transmission coefficient

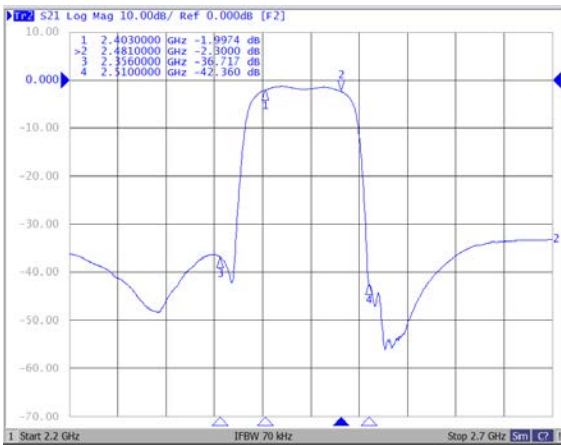

Figure 3: |S21|

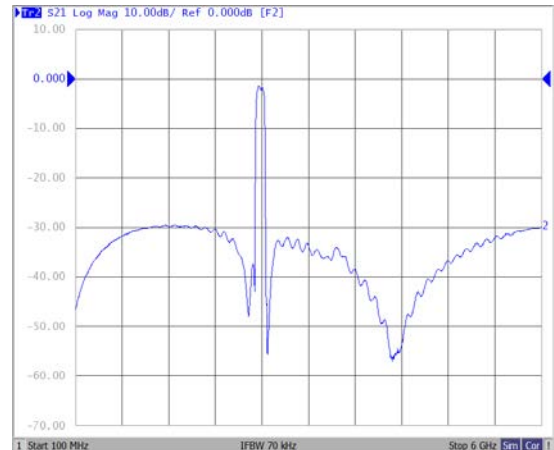

Figure 4: Wide Band |S21|

## 10 Reflection coefficients

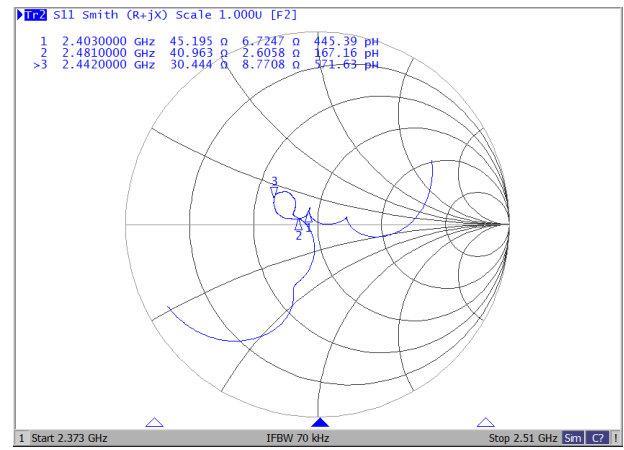
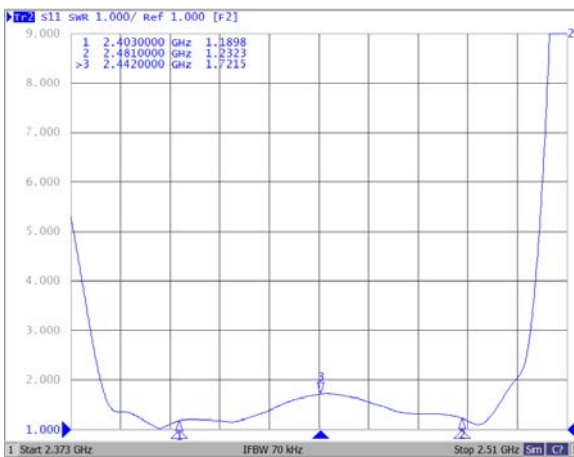

Figure 5: Reflection coefficient for S11

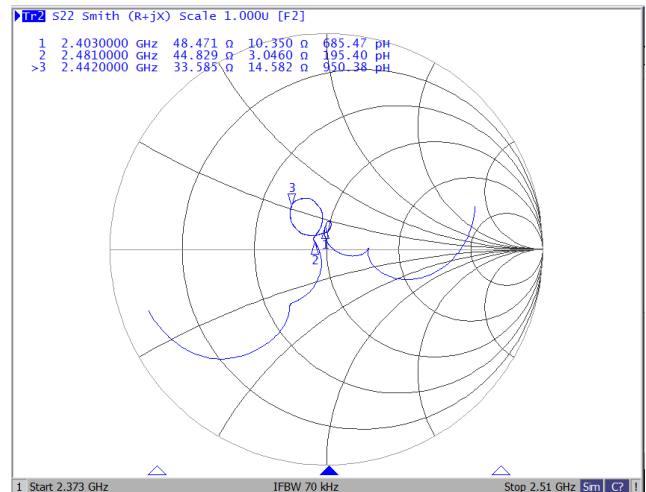
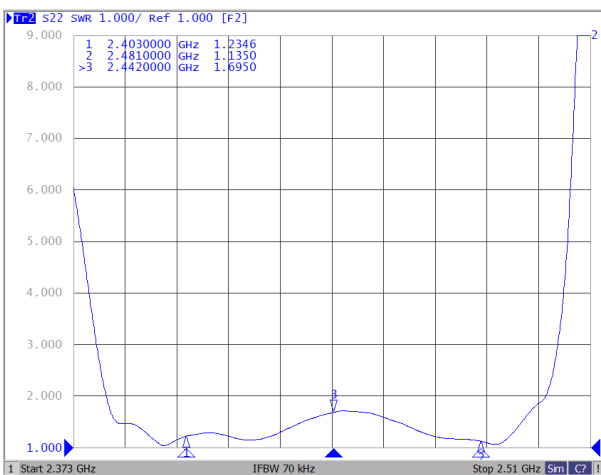

Figure 6: Reflection coefficient for S22

## 11 Packing material

### 11.1 Tape

Tensile Strength of Carrier Tape: Carrier tape 10N or more; Cover tape 5N or more. Packaging quantities: 5000 PCS / Reel.

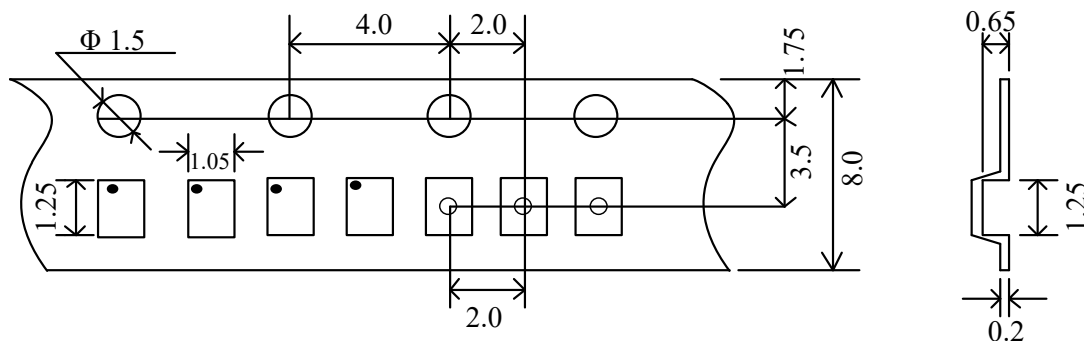

Figure 7: Drawing of tape with tape dimensions according above.

### 11.2 Reel with diameter of 178mm

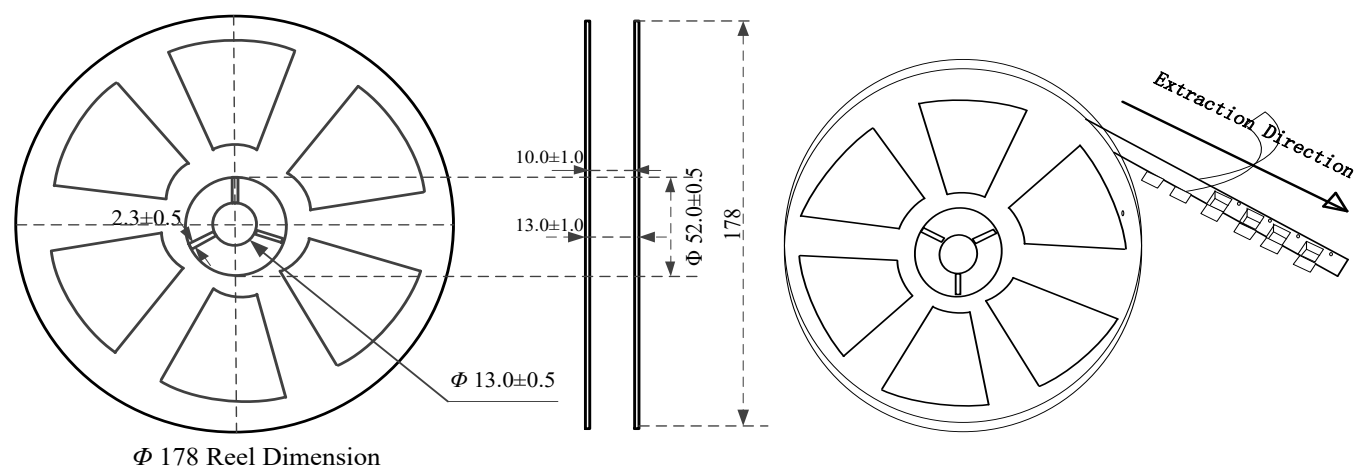

Figure 8: Drawing of reel with diameter of 178mm.

## 12 Recommended Soldering Profile

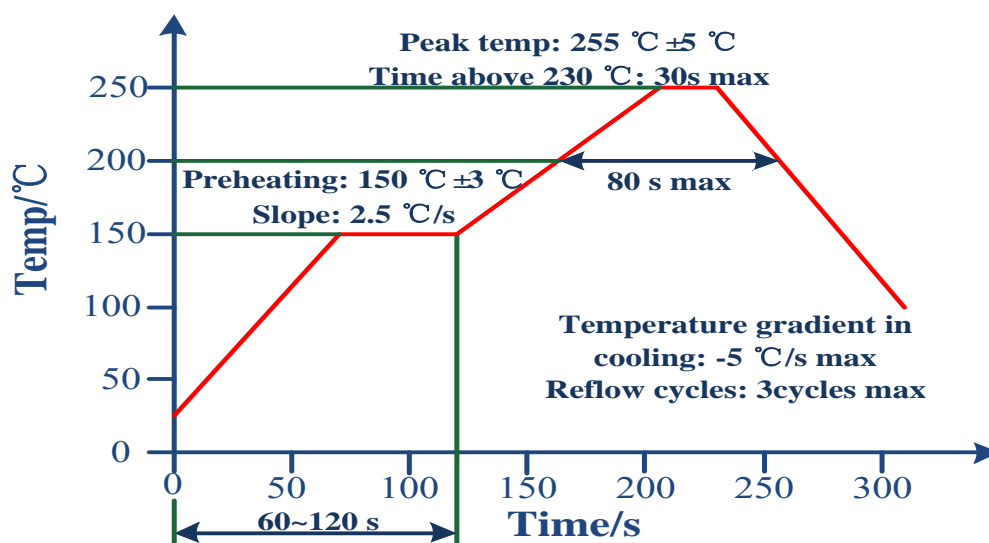

Figure 12: Recommended Reflow profile for convection and infrared soldering-lead-free solder.

## 13 Important Notice

- SAW devices should not be used in any type of fluid such as water, oil, organic solvent, etc..
- Do not operate outside the recommended operating temperature range.
- Sudden change of temperature shall be avoided, deterioration of the characteristics may occur.
- Be careful of temperature and duration when soldering.
- Do not place soldering iron on the body.
- Be careful not to subject for excessive force.
- SAW devices are electrostatic sensitive. Please avoid static voltage during operation and storage.
- Ultrasonic cleaning shall be avoided. Ultrasonic vibration may cause destruction.
- ROHS compliance.
- ESD (Electrostatic Discharge) sensitive device.

## X-ON Electronics

Largest Supplier of Electrical and Electronic Components

*Click to view similar products for [Signal Conditioning](#) category:*

*Click to view products by [Suntek](#) manufacturer:*

Other Similar products are found below :

[MAPDCC0001](#) [MAPDCC0004](#) [PD0409J5050S2HF](#) [HHS-109-PIN](#) [AFS14A35-1591.50-T3](#) [DS-323-PIN](#) [DSS-313-PIN](#) [B39321R801H210](#)  
[1A0220-3](#) [JP510S](#) [LFB212G45SG8C341](#) [LFB322G45SN1A504](#) [LFL182G45TC3B746](#) [SF2159E](#) [30057](#) [AFS1575.42S4-T](#) [FM-104-PIN](#)  
[CER0813B](#) [MAPDCC0005](#) [3A325](#) [40287](#) [41180](#) [ATB3225-75032NCT](#) [BD0810N50100AHF](#) [JHS-115-PIN](#) [DC0710J5005AHF](#)  
[DC2327J5005AHF](#) [43020](#) [LFB2H2G60BB1C106](#) [LFL15869MTC1B787](#) [X3C19F1-20S](#) [XC3500P-20S](#) [10013-20](#) [SF2194E](#)  
[CDBLB455KCAX39-B0](#) [TGL2208-SM, EVAL](#) [RF1353C](#) [051157-0000](#) [PD0922J5050D2HF](#) [1E1305-3](#) [1F1304-3S](#) [1G1304-30](#)  
[B0922J7575AHF](#) [10017-3](#) [TP-103-PIN](#) [BD1222J50200AHF](#) [BD1722J50100AHF](#) [2450DP39K5400E](#) [BD0810J50150AHF](#)  
[BD1722J50200AHF](#)