



SK3700S

WLAN, RF SAW Filter
Revision 0: MAY 2015

MSD/MSL 3



- Electrical Characteristics
 - Package Dimensions
 - Testing Environment
 - Frequency Characteristics
-

□ Electrical Characteristics

Maximum Ratings

Parameters Description	Unit	Minimum	Typical	Maximum
Operating Temperature Range	°C	-30	-	+85
Storage Temperature Range	°C	-40	-	+85
Maximum DC Voltage	V	-	-	0
Maximum Input Power	dBm	-	-	28
Source Impedance (single ended) ⁽¹⁾	Ω	-	50	-
Load Impedance (single ended) ⁽¹⁾	Ω	-	50	-
Package type & size	C12			
Length x Width	mm ²	-	1.1 x 0.9	-
Height	mm	-	-	0.5

Electrical Specification

Parameters Description	Unit	Minimum	Typical	Maximum
Center Frequency (Fo)	MHz	-	2450.0	-
Max.Insertion Loss within 2400.0~2500.0 MHz	dB	-	1.5	2.5
Amplitude Ripple within 2400.0~2500.0 MHz	dB _{p-p}	-	0.55	1.5
Attenuation:				
D.C ~ 960.0 MHz	dB	35	53	-
960.0 ~ 1570.0 MHz	dB	35	45	-
1570.0 ~ 1580.0 MHz	dB	35	45	-
1580.0 ~ 1710.0 MHz	dB	35	43	-
1710.0 ~ 1910.0 MHz	dB	33	38	-
1910.0 ~ 1980.0 MHz	dB	35	42	-
2110.0 ~ 2170.0 MHz	dB	28	32	-
2640.0 ~ 3000.0 MHz	dB	20	25	-
3000.0 ~ 4800.0 MHz	dB	15	20	-
4800.0 ~ 5000.0 MHz	dB	15	19	-
5000.0 ~ 6000.0 MHz	dB	15	18	-
VSWR within 2400.0~2500.0 MHz	-	-	1.9	2.3

Notes : (1) With Matching Network (Ref. Testing Environment Circuit as shown below).

Package Dimensions

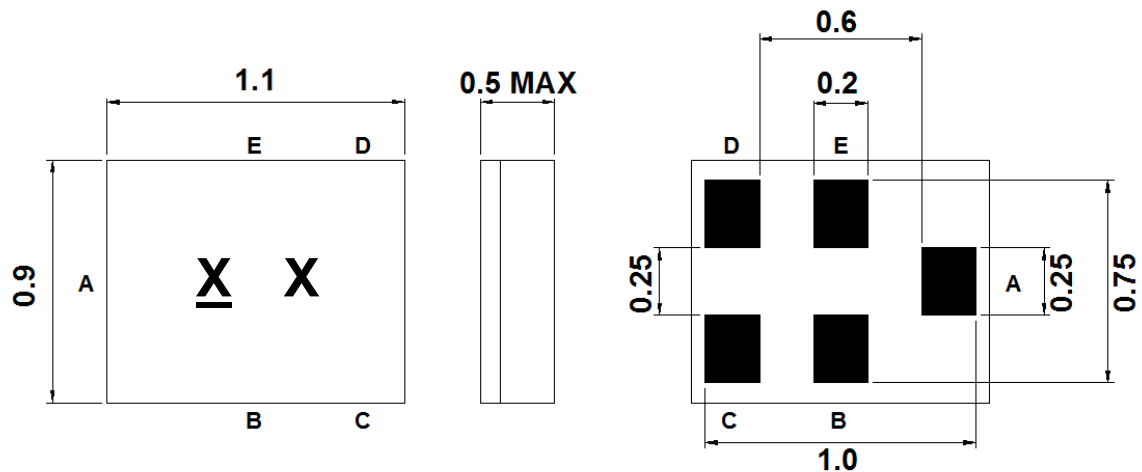

Marking Descriptions	
X	Series Number
X	Date Code(Year+Month)

Pin Description	
B, C, E	Ground
A	Input
D	Output

Testing Environment

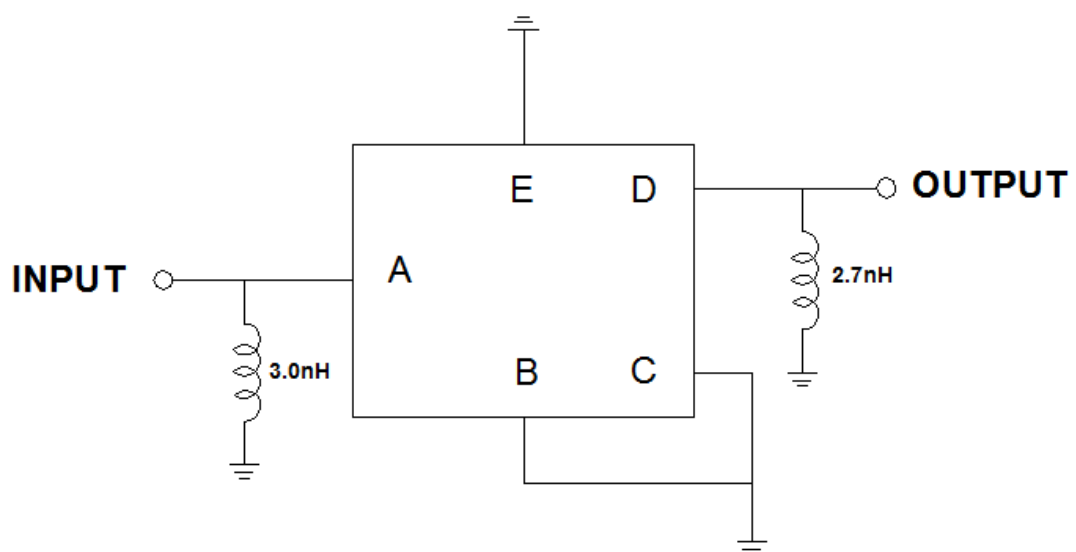

Source & Load Impedance: 50 Ω

□ Frequency Characteristics

Frequency Response

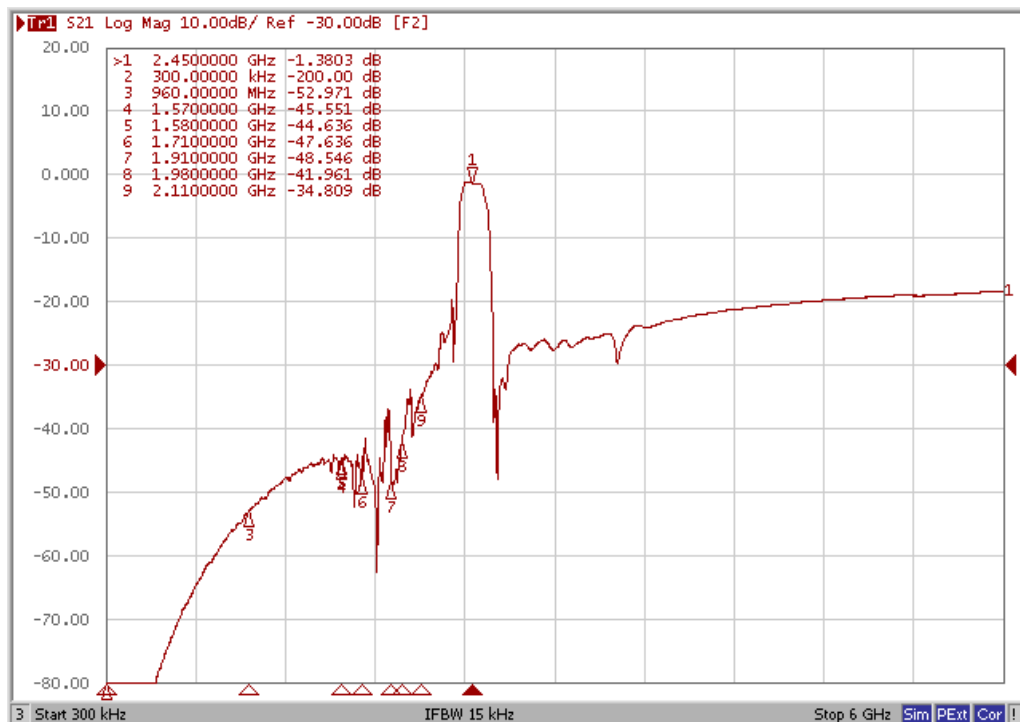
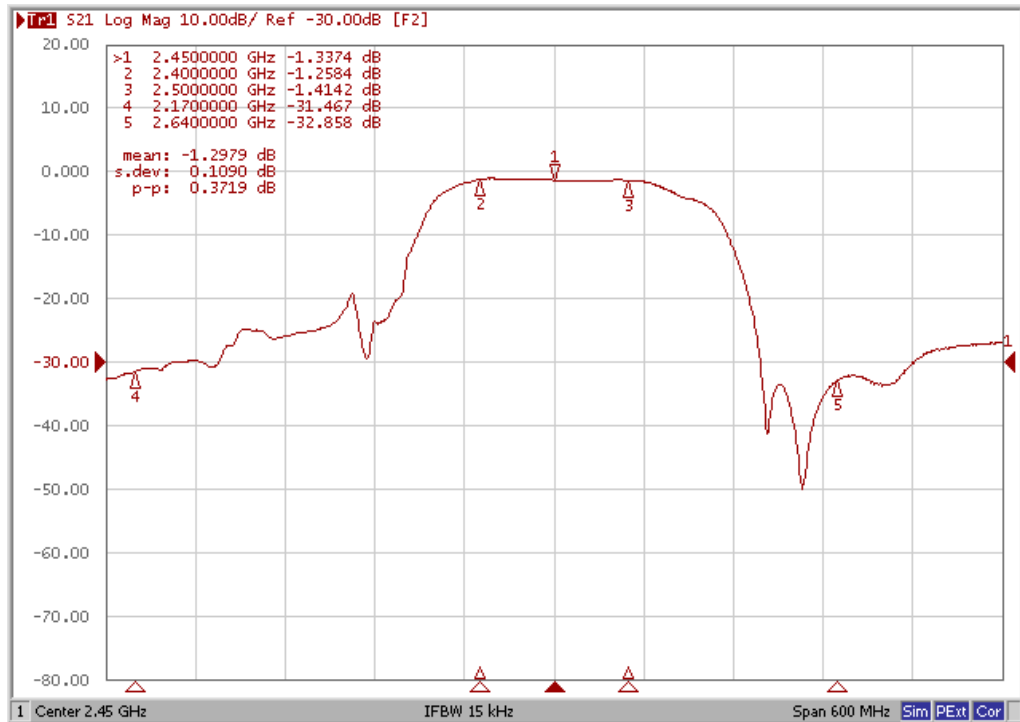

VSWR

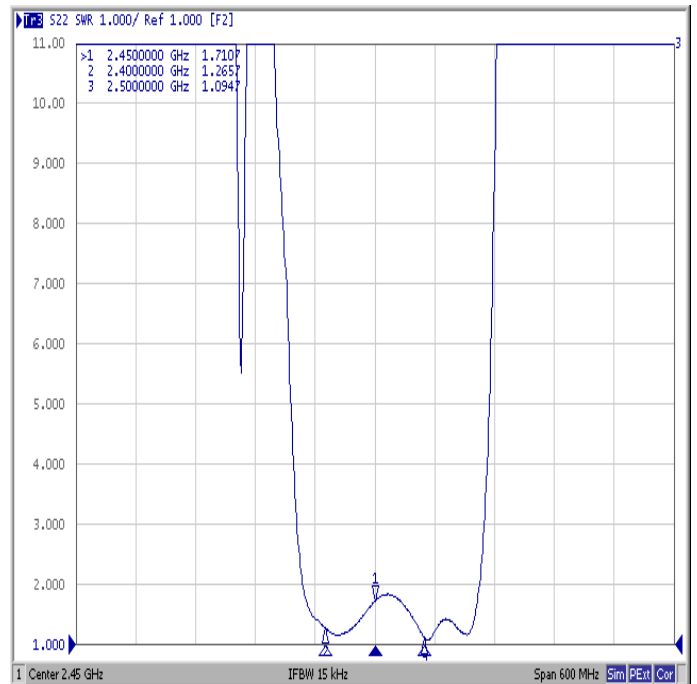
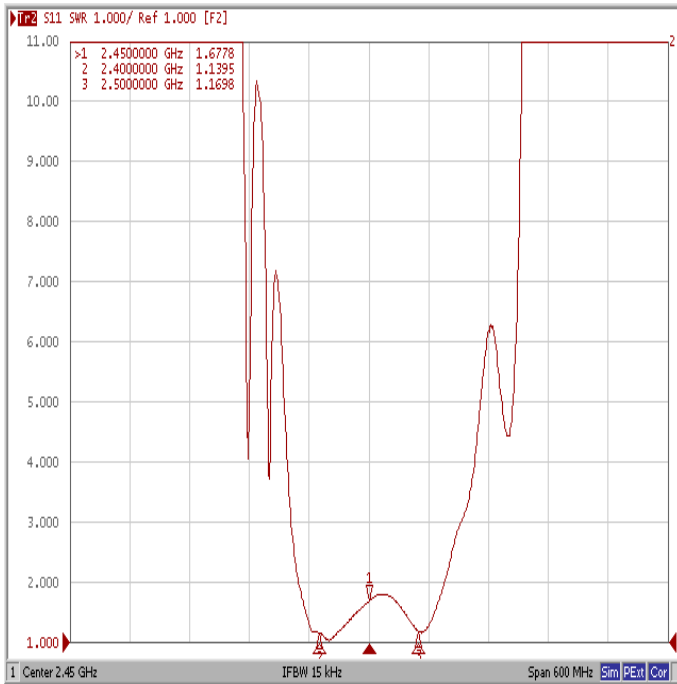

Smith Chart

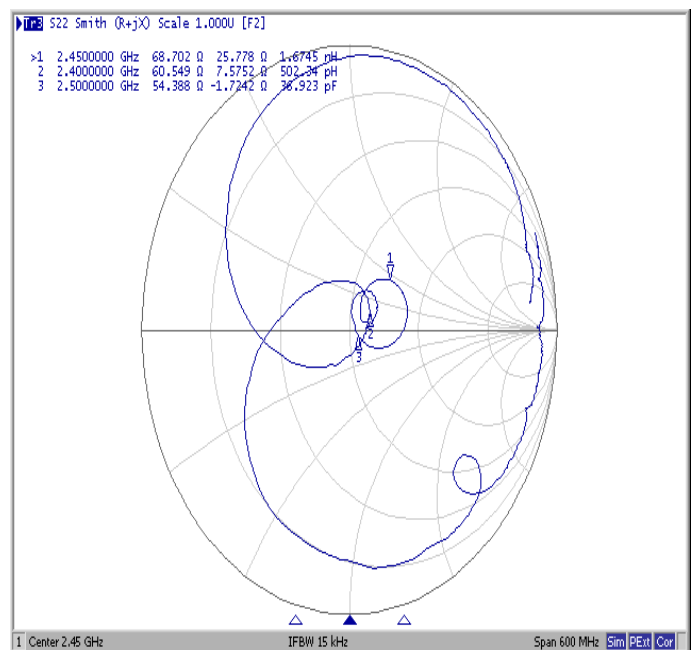
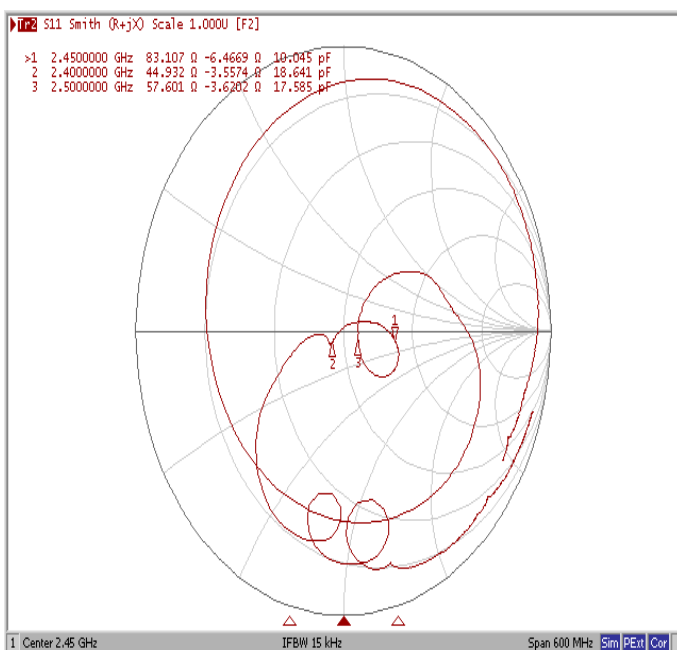

X-ON Electronics

Largest Supplier of Electrical and Electronic Components

Click to view similar products for [Signal Conditioning](#) category:

Click to view products by [Suntek](#) manufacturer:

Other Similar products are found below :

[MAPDCC0001](#) [MAPDCC0004](#) [PD0409J5050S2HF](#) [HHS-109-PIN](#) [AFS14A30-2185.00-T3](#) [AFS14A35-1591.50-T3](#) [DS-323-PIN](#) [DSS-313-PIN](#) [B39321R801H210](#) [1A0220-3](#) [JP510S](#) [LFB212G45SG8C341](#) [LFB322G45SN1A504](#) [LFL182G45TC3B746](#) [SF2159E](#) [30057](#)
[AFS1575.42S4-T](#) [FM-104-PIN](#) [CER0813B](#) [MAPDCC0005](#) [3A325](#) [40287](#) [41180](#) [ATB3225-75032NCT](#) [BD0810N50100AHF](#) [JHS-115-PIN](#)
[DC0710J5005AHF](#) [DC2327J5005AHF](#) [43020](#) [LFB2H2G60BB1C106](#) [LFL15869MTC1B787](#) [X3C19F1-20S](#) [XC3500P-20S](#) [10013-20](#)
[SF2194E](#) [CDBLB455KCAX39-B0](#) [TGL2208-SM, EVAL](#) [RF1353C](#) [051157-0000](#) [PD0922J5050D2HF](#) [1E1305-3](#) [1F1304-3S](#) [1G1304-30](#)
[B0922J7575AHF](#) [10017-3](#) [TP-103-PIN](#) [BD1222J50200AHF](#) [BD1722J50100AHF](#) [2450DP39K5400E](#) [BD0810J50150AHF](#)