

# SK6014 Low Noise, High PSRR, High Speed, CMOS LDO

## GENERAL DESCRIPTION

The SK6014 is a high accuracy, low noise, high speed, low dropout CMOS Linear regulator with high ripple rejection and fast discharge function. The device offers a new level of cost effective performance in cellular phones, surveillance system, Bluetooth, wireless and other portable electronic devices.

SK6014 can provide product selections of output value in the range of 1.0V~3.6V by every 0.1V step.

SK6014 offer over temperature protection to ensure the device working in well conditions.

The SK6014 regulators are available in standard SOT23-5L, SOT89-3L packages.

Standard products are Pb-free and Halogen-free.

## FEATURES

- Input voltage: 2.5V~6.5V
- Output range: 1.0V~3.6V  
(customized by every 0.1V step)
- Maximum output current: 750mA@  
 $V_{IN}-V_{OUT}=0.5V$
- PSRR: 75dB @1KHz 55dB@1MHz
- Dropout voltage: 110mV @  $I_{OUT}=200mA$
- Quiescent current :45 $\mu A$  Typ.
- Shut-down current: <1 $\mu A$
- Recommend capacitor: 1 $\mu F$
- Ultra-low output noise: 20 $\mu V_{RMS}$

## APPLICATIONS

- Digital cameras
- Cellphones
- Bluetooth and wireless handsets
- Other portable electronic devices

## TYPICAL APPLICATION CIRCUIT

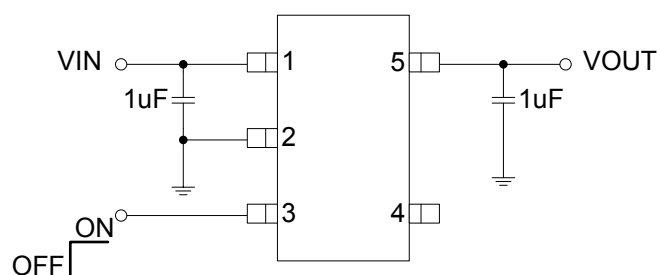

## PIN ASSIGNMENT



SOT23-5L

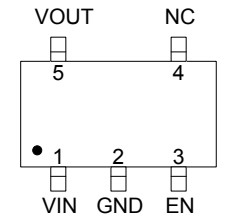

SOT23-5L (Top View)

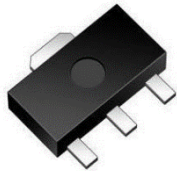

SOT89-3L

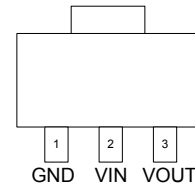

SOT89-3L (Top View)

## ORDER INFORMATION

PART NO	PACAKGE	VOUT DISCHARGE	TEMPERATURE	TAPE & REEL
SK6014AS5-XX <sup>Note</sup>	SOT23-5L	Yes	-40 ~ +85°C	3000/REEL
SK6014AT3-XX <sup>Note</sup>	SOT89-3L	Yes	-40 ~ +85°C	3000/REEL

**Note:** XX indicates 1.0V~3.6V by 0.1V step. For example, 28 means product outputs 2.8V

## PART NUMBER RULES

SK6014<sup>1</sup>-<sup>2</sup>-<sup>3</sup>

Code	Description
<sup>1</sup>	Vout discharge A: Yes; B: No
<sup>2</sup>	Package: S5: SOT23-5L T3:SOT89-3L(Btypepin-out)
<sup>3</sup>	Voltage version: XX: 1.0V~3.6V by0.1V step Example: 28: 2.8V

## MARKING DESCRIPTION:

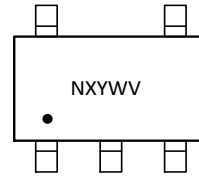

SOT23-5L

“N”: Product code,here use “N” stands for “SK6014”.

“X”: Packagefactory

“Y”:Wafer foundry vendor.

“W”: The week of manufacturing. “A” stands for week

1, “Z” stands for week 26, “a” stands for week

27, “z” stands for week 52.

“V”: Output voltage code.

SOT89-3L:

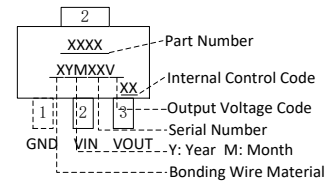

## PIN DESCRIPTION

PIN NO	SYMBOL	I/O	DESCRIPTION
SOT23-5L			
1	VIN	Power	Input
2	GND	Ground	Ground
3	EN	I	Enable (active high, do not float)
4	NC	/	Not connected
5	VOUT	O	Output

PIN NO	SYMBOL	I/O	DESCRIPTION
SOT89-3L			
1	GND	Ground	Ground
2	VIN	Power	Input
3	VOUT	O	Output

## TYPICAL OUTPUT VOLTAGE CODE TABLE

$V_{OUT}$	CODE	$V_{OUT}$	CODE
1.0V	A	1.2V	B
1.5V	C	1.8V	D
2.8V	M	3.0V	G
3.3V	H	3.6V	I

## ABSOLUTE MAXIMUM RATINGS (Note)

SYMBOL	ITEMS	VALUE	UNIT
$V_{IN}$	Input Voltage	-0.3~8	V
$I_{OUT}$	Output Current	550	mA
$P_{DMAX}$	Power Dissipation	SOT23-5L	0.3
		SOT89-3L	0.5
$T_J$	Junction Temperature	-40~125	°C
$T_A$	Ambient Temperature	-40~85	°C
$T_{STG}$	Storage Temperature	-55 to 150	°C
$T_{SOLDER}$	Package Lead Soldering Temperature	260°C, 10s	

**Note:** Exceed these limits to damage to the device. Exposure to absolute maximum rating conditions may affect device reliability.

## RECOMMENDED OPERATING RANGE

SYMBOL	ITEMS	VALUE	UNIT
$V_{IN}$	Supply Voltage	2.5to 6.5	V
$I_{OUT}$	Output Current	<300	mA
$T_{OPT}$	Operating Temperature	-40 to +85	°C

## SIMPLIFIED BLOCK DIAGRAM

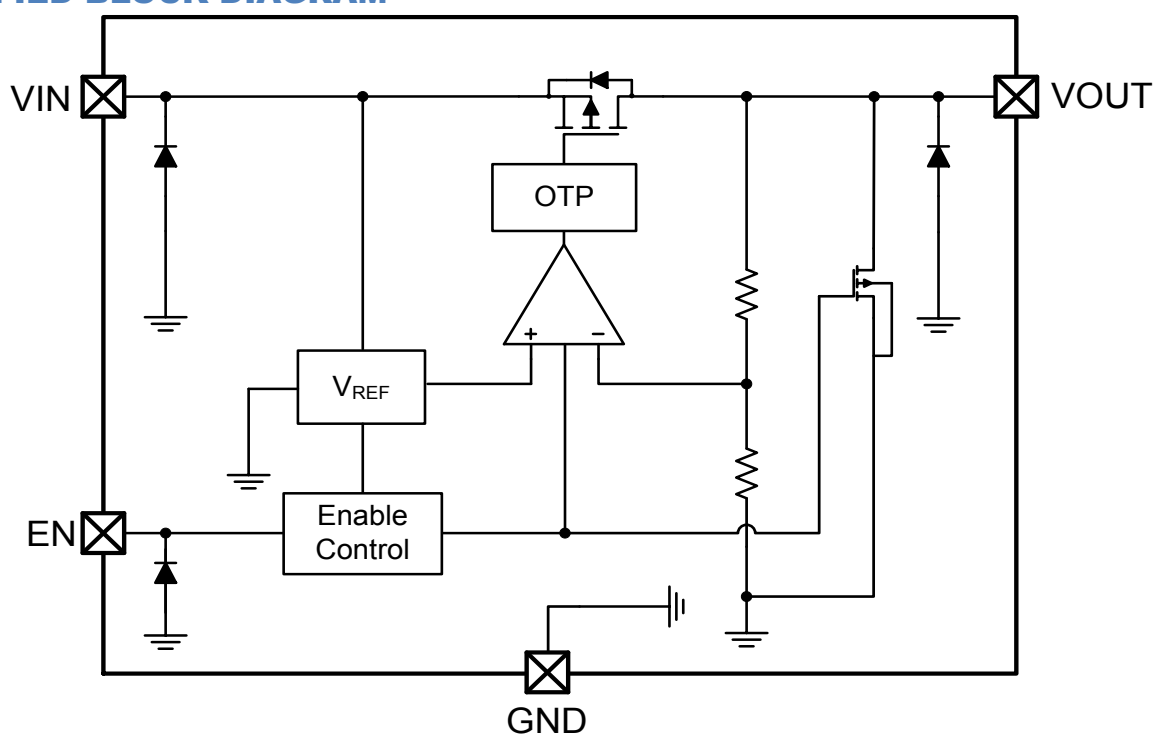

## ELECTRICAL CHARACTERISTICS

The following specifications apply for  $V_{IN}=4.3V$ ,  $V_{OUT}=3.3V$ ,  $T_A=25^{\circ}C$ , unless specified otherwise.

SYMBOL	ITEMS	CONDITIONS	MIN	TYP	MAX	UNIT
$V_{IN}$	Input Voltage				6.5	V
$V_{OUT}$	Output Range	$V_{OUT}<2V$ , $V_{IN}=2.7V$ , $I_{OUT}=1mA$	-3	$V_{OUT}$	3	%
		$V_{OUT}\geq 2V$ , $I_{OUT}=1mA$	-2	$V_{OUT}$	2	
$I_Q$	Quiescent Current	$V_{OUT}=3.3V$ , $I_{OUT}=0$		45		$\mu A$
$I_{OUT\_PK}$	Maximum Output Current	$V_{IN}=V_{EN}=4.3V$		700		mA
$V_{DROP}$	Dropout Voltage	$V_{OUT}=3.3V$ , $I_{OUT}=200mA$		110	125	mV
		$V_{OUT}=3.3V$ , $I_{OUT}=300mA$		160	175	
$\Delta V_{LINE}$	Line Regulation	$V_{IN}=3.5\sim 5.5V$ , $I_{OUT}=1mA$		0.01	0.15	%/V
$\Delta V_{LOAD}$	Load Regulation	$V_{OUT}=3.3V$ , $I_{OUT}=1\sim 300mA$		40	70	mV
$I_{SHDN}$	Shut-down Current	$V_{EN}=0V$			1	$\mu A$
PSRR	Power Supply Rejection Rate	$V_{IN}=5V_{DC}+0.5V_{P-P}$ $F=1KHz$ , $I_{OUT}=10mA$		75		dB
		$V_{IN}=5V_{DC}+0.5V_{P-P}$ $F=1MHz$ , $I_{OUT}=10mA$		55		
$V_{ENH}$	EN logic high voltage	$V_{IN}=5.5V$ , $I_{OUT}=1mA$	1.2		$V_{IN}$	V
$V_{ENL}$	EN logic low voltage	$V_{IN}=5.5V$ , $V_{OUT}=0V$			0.4	V
$I_{EN}$	EN Input Current	$V_{EN}=0$ to 5.5V			1.0	$\mu A$
$e_{NO}$	Output Noise Voltage	10Hz to 100KHz, $C_{OUT}=1\mu F$		20		$\mu V_{RMS}$
$T_{SD}$	Thermal Shutdown Protection	$V_{IN}=V_{EN}=4.3V$ , $I_{OUT}=1mA$		160		$^{\circ}C$

## TYPICAL PERFORMANCE CHARACTERISTICS

$C_{IN}=1\mu F$ ,  $C_{OUT}=1\mu F$ ,  $V_{IN}=4.3V$ ,  $V_{OUT}=3.3V$ ,  $T_A=25^\circ C$ , unless specified otherwise. (Package:SOT23-5L)

**IQ vs. Input Voltage**

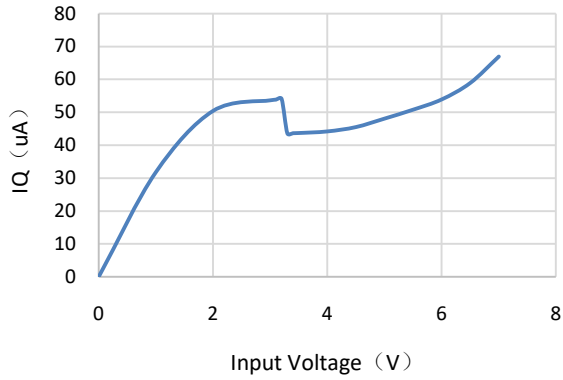

**IQ vs. Temperature**

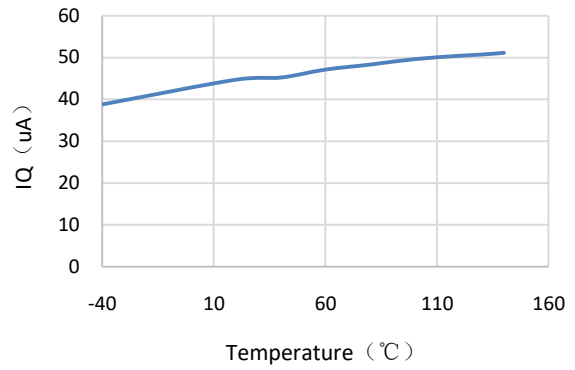

**Output Voltage vs. Input Voltage**

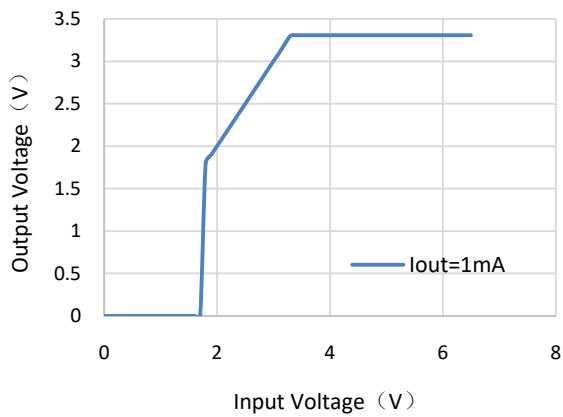

**Output Voltage vs. Temperature**

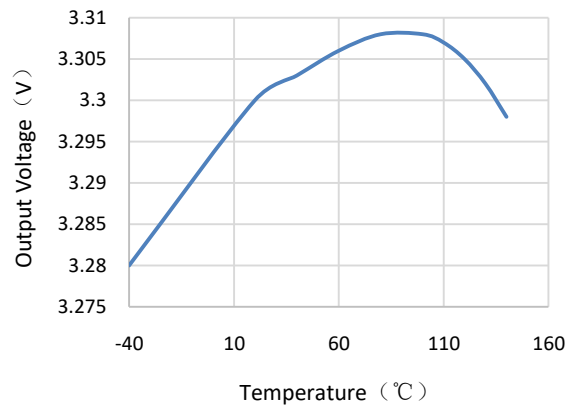

**output voltage vs. output current**

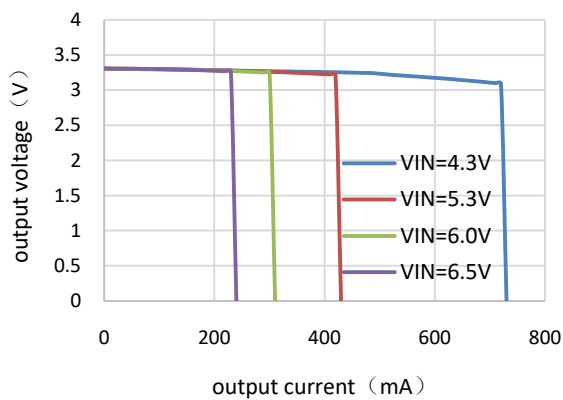

**Dropout Voltage vs. Output Current**

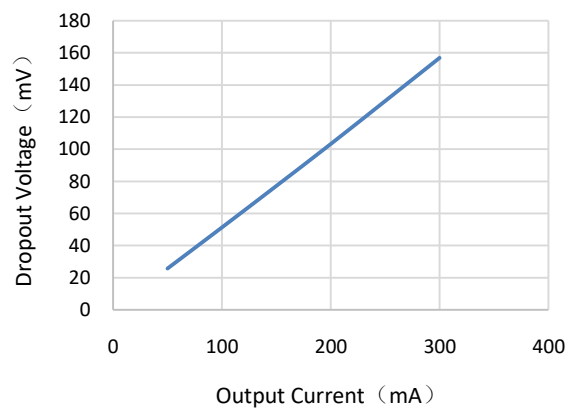

PSRR vs. Frequency

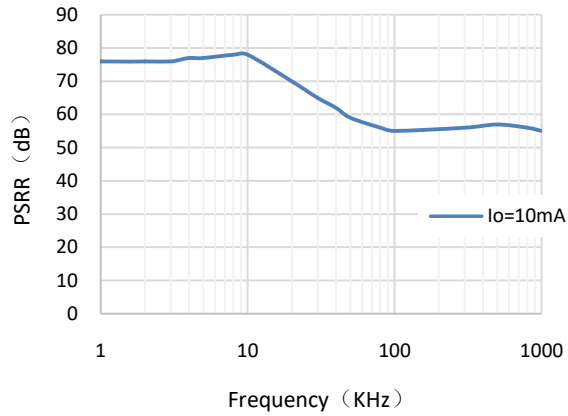

CH1:V<sub>IN</sub> CH2:V<sub>OUT</sub> CH3:EN CH4:I<sub>OUT</sub>

EN ON/OFF

EN=0V to 3V, I<sub>OUT</sub>=10mA

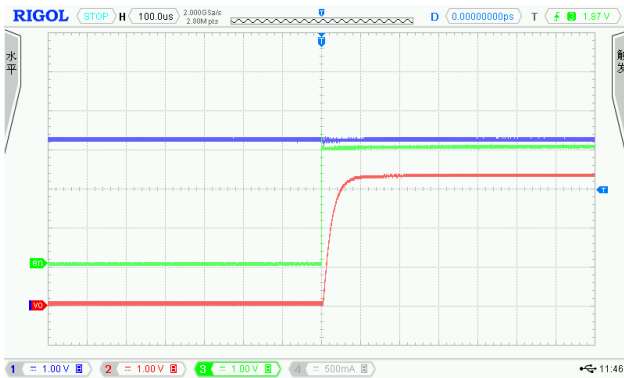

EN=3V to 0V, I<sub>OUT</sub>=10mA



POWER ON/OFF

V<sub>IN</sub>=0V to 4.3V, I<sub>OUT</sub>=10mA

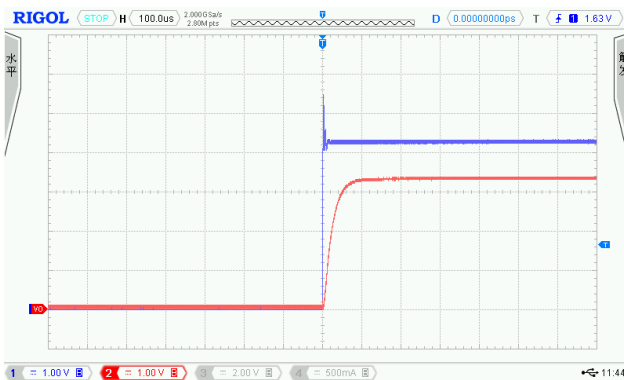

V<sub>IN</sub>=4.3V to 0V, I<sub>OUT</sub>=10mA

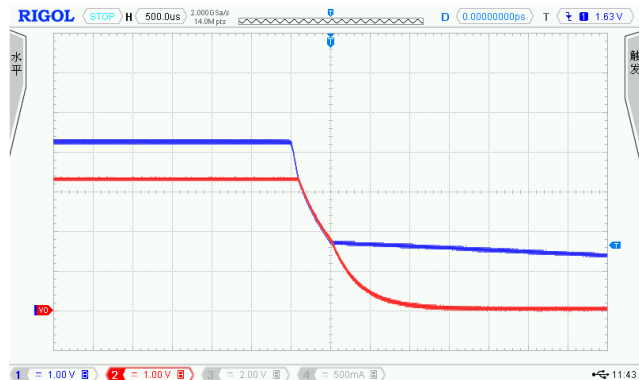

## LINE TRANSIENT

$V_{IN}=4.3V$  to  $5.3V$ ,  $I_{OUT}=10mA$

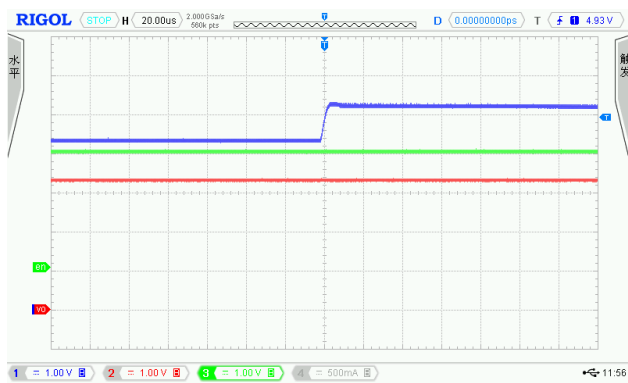

$V_{IN}=5.3V$  to  $4.3V$ ,  $I_{OUT}=10mA$



## LOAD TRANSIENT

$V_{IN}=4.3V$ ,  $I_{OUT}=1mA$  to  $60mA$

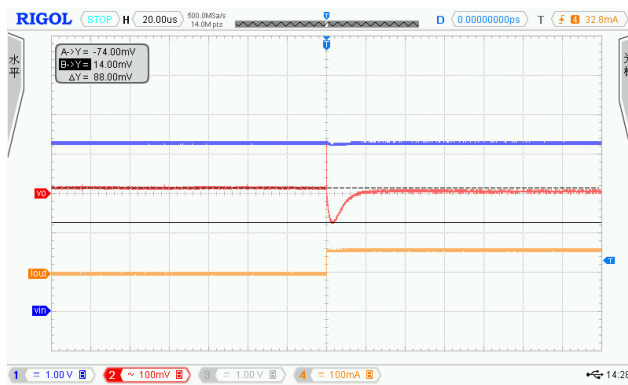

$V_{IN}=4.3V$ ,  $I_{OUT}=60mA$  to  $1mA$

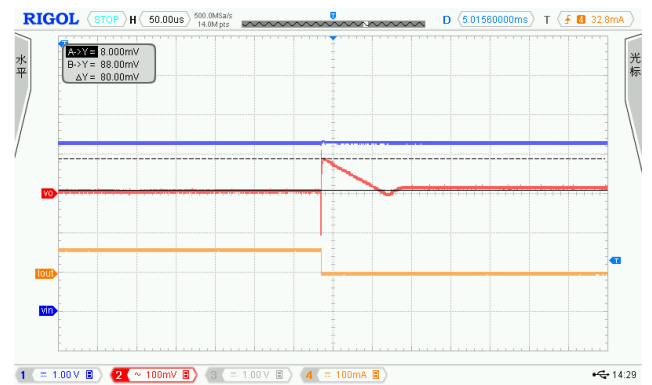

$V_{IN}=4.3V$ ,  $I_{OUT}=1mA$  to  $200mA$

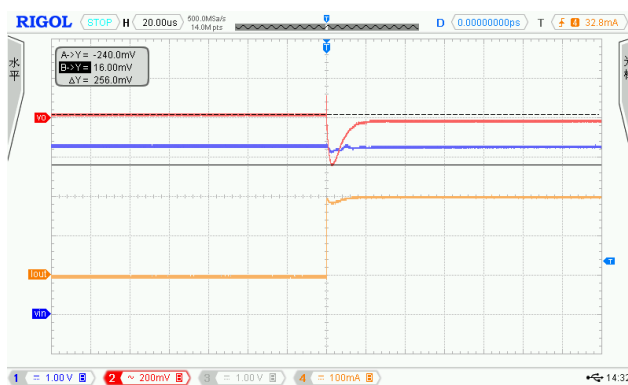

$V_{IN}=4.3V$ ,  $I_{OUT}=200mA$  to  $1mA$

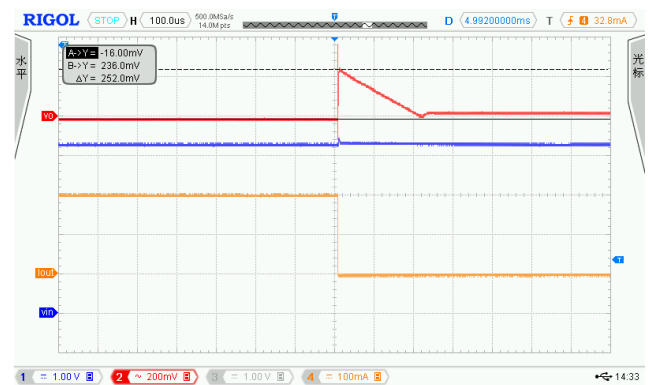

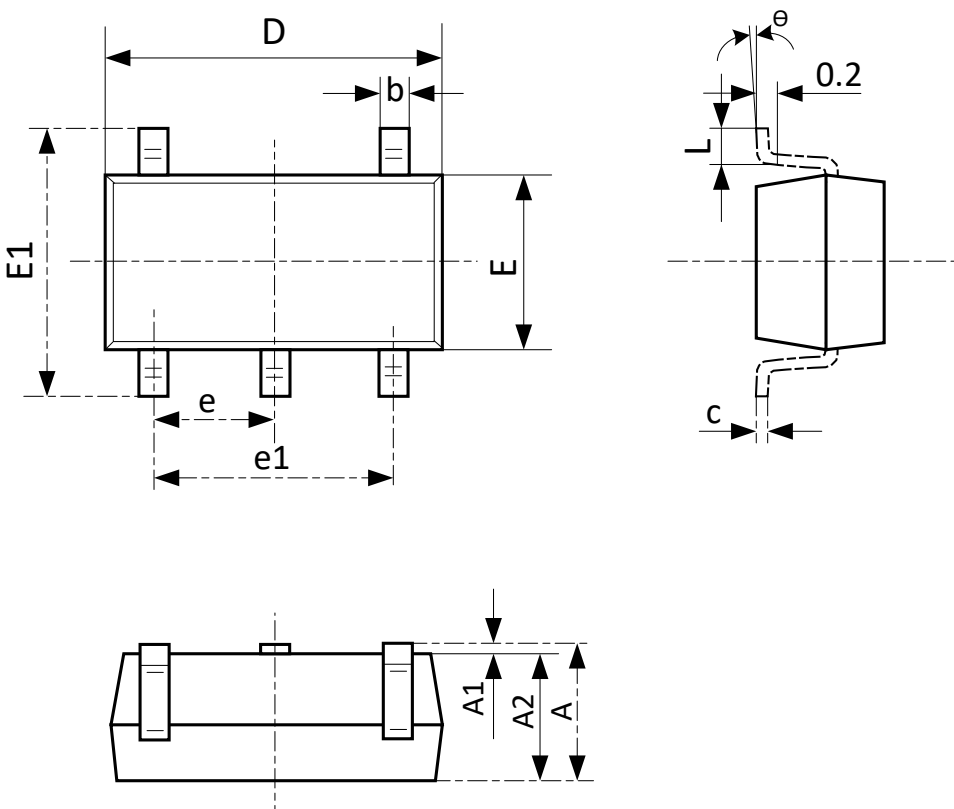

## PACKAGE OUTLINE

Package	SOT23-5L	Devices per reel	3000Pcs	Unit	mm
Package Dimension:					
					
Symbol	Dimensions In Millimeters		Dimensions In Inches		
	Min	Max	Min	Max	
A	1.050	1.250	0.041	0.049	
A1	0.000	0.100	0.000	0.004	
A2	1.050	1.150	0.041	0.045	
b	0.300	0.500	0.012	0.020	
c	0.100	0.200	0.004	0.008	
D	2.820	3.020	0.111	0.119	
E	1.500	1.700	0.059	0.067	
E1	2.650	2.950	0.104	0.116	
e	0.950(BSC)		0.037(BSC)		
e1	1.800	2.000	0.071	0.079	
L	0.300	0.600	0.012	0.024	
$\theta$	0°C	8°C	0°C	8°C	

## PACKAGE OUTLINE

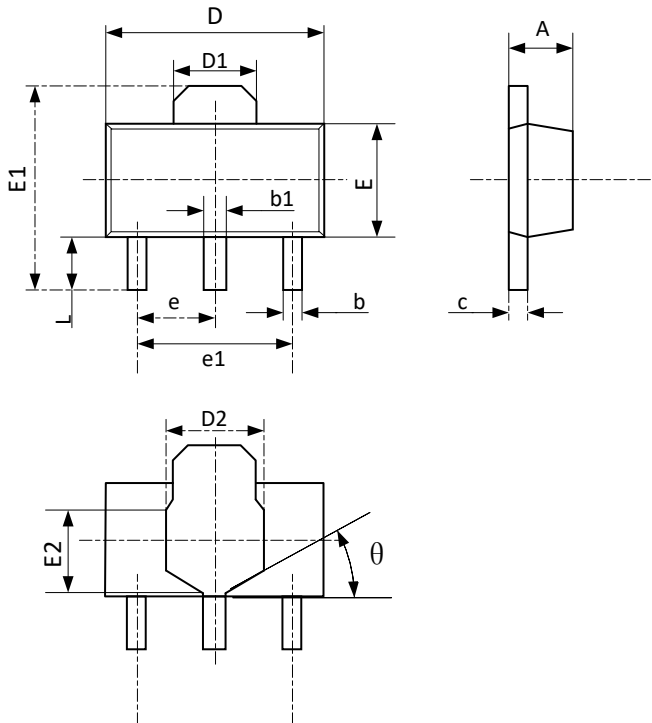
Package	SOT89-3L	Devices per reel	3000Pcs	Unit	mm
Package Dimension:					
					
Symbol	Dimensions In Millimeters		Dimensions In Inches		
	Min	Max	Min	Max	
A	1.400	1.600	0.055	0.063	
b	0.320	0.520	0.013	0.020	
b1	0.400	0.580	0.016	0.023	
c	0.350	0.440	0.014	0.017	
D	4.400	4.600	0.173	0.181	
D1	1.550 REF		0.061 REF		
D2	1.750 REF		0.069 REF		
E	2.300	2.600	0.091	0.102	
E1	3.940	4.250	0.155	0.167	
E2	1.900 REF		0.075 REF		
e	1.500 TYP		0.060 TYP		
e1	3.000 TYP		0.118 TYP		
L	0.900	1.200	0.035	0.047	
$\theta$	45°		45°		

## X-ON Electronics

Largest Supplier of Electrical and Electronic Components

*Click to view similar products for [Linear Voltage Regulators](#) category:*

*Click to view products by [Suntek](#) manufacturer:*

Other Similar products are found below :

[LV56831P-E](#) [LV5684PVD-XH](#) [MCDTSA6-2R](#) [L7815ACV-DG](#) [PQ3DZ53U](#) [LV56801P-E](#) [TLE42794G](#) [L78L05CZ/1SX](#) [L78LR05DL-MA-E](#) [636416C](#) [714954EB](#) [BA033LBSG2-TR](#) [LV5680P-E](#) [L78M15CV-DG](#) [TLS202B1MBV33HTSA1](#) [L79M05T-E](#) [TLS202A1MBVHTSA1](#) [L78LR05D-MA-E](#) [NCV317MBTG](#) [NTE7227](#) [LV5680NPVC-XH](#) [LT1054CN8](#) [MP2018GZD-5-Z](#) [MP2018GZD-33-Z](#) [MIC5281-3.3YMM](#) [RT9078-28GQZ](#) [MC78L06BP-AP](#) [TA48LS05F\(TE85L,F\)](#) [TA78L12F\(TE12L,F\)](#) [TC47BR5003ECT](#) [TCR2LN12,LF\(S](#) [TCR2LN28,LF\(S](#) [TCR2LN30,LF\(S](#) [TCR3DF295,LM\(CT](#) [TCR3DF40,LM\(CT](#) [BA178M20CP-E2](#) [L78M12ABDT](#) [LM7812SX/NOPB](#) [LR645N3-G-P003](#) [LR645N3-G-P013](#) [ZXTR2005P5-13](#) [SCD7812BTG](#) [TCR3DF335,LM\(CT](#) [ZXTR2012K-13](#) [TLE42994E V33](#) [ZXTR2008K-13](#) [ZXTR2005K-13](#) [LA5693D-E](#) [L88R05DL-E](#) [ADP3300ARTZ-2.7RL7](#)