

SK6017

300mA, Low Consumption, CMOS LDO

GENERAL DESCRIPTION

The SK6017 series are low dropout linear regulators and optimized to provide a high performance solution for battery power system to deliver low quiescent current. The devices offer a new level of cost effective performance in cellular phones, laptop and notebook computers, and other portable devices.

The SK6017 series are designed to make use of low cost ceramic capacitors which ensure the stability of the output current, and enhance the efficiency in order to prolong the battery life of those portable devices.

SK6017 can provide product selections of output value in the range of 1.2V~3.6V by every 0.1V step.

The SK6017 regulators are available in SOT23-5L packages. Standard products are Pb-free and Halogen free products.

FEATURES

- Input voltage: 2.5V~6.5V
- Output range: 1.2V~3.6V
(customized by every 0.1V step)
- Output current: 300mA @ $V_{OUT} > 2V$
- Dropout voltage: 100mV @ $I_{OUT} = 100mA$
- Quiescent current : 1 μ A Typ.
- Shut-down current: < 0.1 μ A
- Recommend capacitor: 1 μ F

APPLICATIONS

- Reference voltage source
- Toys
- Bluetooth, wireless handsets
- Others portable electronic device

TYPICAL APPLICATION CIRCUIT

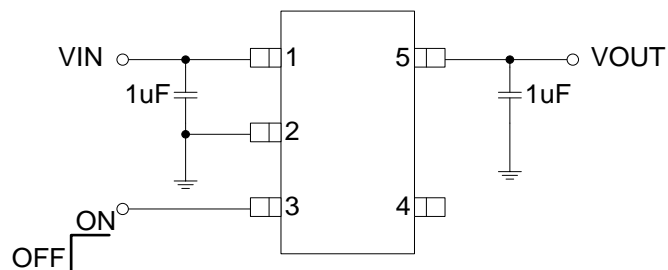

PIN ASSIGNMENT

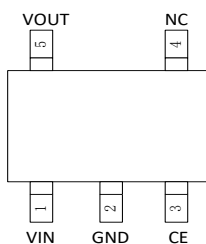

(Top View)

TYPICAL PERFORMANCE

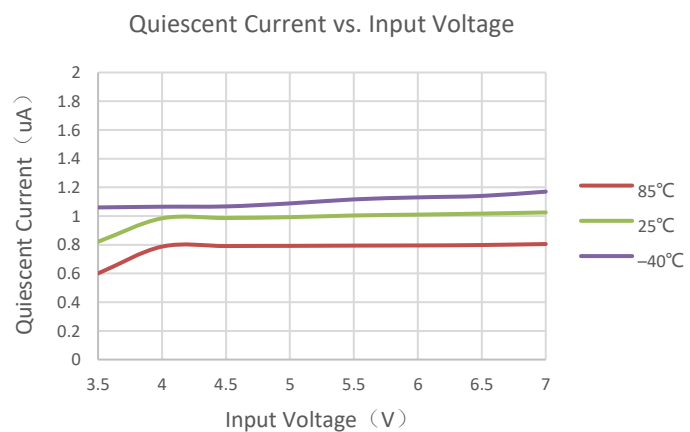

ORDER INFORMATION

PART NO	ACCURACY	PACAKGE	TEMPERATURE	TAPE & REEL
SK6017S5-XX	2%	SOT23-5L	-40 ~ +85°C	3000/REEL

Note: XX indicates 1.2V~3.6V by 0.1V step. For example, 33 means product outputs 3.3V.

PART NUMBER RULES

SK6017^[1]_[2]

Code	Description
[1]	Package: S5: SOT23-5L
[2]	Voltage version: XX: 1.2V~3.6V by 0.1V step Example: 33: 3.3V

MARKING DESCRIPTION:

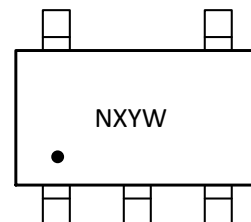

“N”: product code, here use “F” stands for “SK6017”.

“X”: Voltage Code

“Y”: Internal Control Code

“W”: week of manufacturing. “A” stands for week 1,

“Z” stands for week 26, “Ā” stands for week

27, “Z̄” stands for week 52.

PIN DESCRIPTION

PIN NO	SYMBOL	I/O	DESCRIPTION
SOT23-5L			
1	VIN	Power	Input
2	GND	Ground	Ground
3	CE	I	Chip Enable(Active high, do not float)
4	NC	/	Not Connected
5	VOUT	O	Output

ABSOLUTE MAXIMUM RATINGS (Note)

SYMBOL	ITEMS	VALUE	UNIT
V _{IN}	Input Voltage	-0.3~8	V
I _{OUT}	Output Current	350	mA
P _{DMAX}	Power Dissipation	SOT23-5L	0.3
T _J	Junction Temperature	-40~125	°C
T _A	Ambient Temperature	-40~85	°C
T _{STG}	Storage Temperature	-55~150	°C
T _{SOLDER}	Package Lead Soldering Temperature	260°C, 10s	

Note: Exceed these limits to damage to the device. Exposure to absolute maximum rating conditions may affect device reliability.

RECOMMENDED OPERATING RANGE

SYMBOL	ITEMS	VALUE	UNIT
V_{IN}	V_{IN} Supply Voltage	2.5 to 6.5	V
I_{OUT}	Output Current	<300	mA
T_{OPT}	Operating Temperature	-40 to +85	°C

ELECTRICAL CHARACTERISTICS

The following specifications apply for $V_{OUT}=3.3V$ $T_A=25^{\circ}C$, unless specified otherwise.

SYMBOL	ITEMS	CONDITIONS	MIN	TYP	MAX	UNIT
V_{IN}	Input Voltage				6.5	V
V_{OUT}	Output Range	$I_{OUT}=1mA$	-2	V_{OUT}	2	%
I_Q	Quiescent Current	$V_{OUT}=3.3V, I_{OUT}=0$		1	2	μA
I_{LIMIT}	Current Limit	$V_{IN}=V_{CE}, V_{IN}=3.8V, V_{OUT}=3.3V$		300		mA
V_{DROP}	Dropout Voltage	$V_{OUT}=3.3V, I_{OUT}=200mA$		170	200	mV
		$V_{OUT}=3.3V, I_{OUT}=250mA$		250	300	
ΔV_{LINE}	Line Regulation	$V_{IN}=2.7\sim 5.5V, I_{OUT}=1mA$		0.01	0.15	%/V
ΔV_{LOAD}	Load Regulation	$V_{OUT}=2.8V, I_{OUT}=1\sim 300mA$		20	30	mV
I_{SHORT}	Short Current	$V_{CE}=V_{IN},$ V_{OUT} Short to GND with 1Ω		90		mA
I_{SHDN}	Shut-down Current	$V_{CE}=0V$		0.1	1	μA
V_{CEH}	CE Logic High Voltage	$V_{IN}=5.5V, I_{OUT}=1mA$	1.2		V_{IN}	V
V_{CEL}	CE Logic Low Voltage	$V_{IN}=5.5V, V_{OUT}=0V$			0.4	V
I_{CE}	CE Input Current	$V_{CE}=0$ to 5.5V			1.0	μA

SIMPLIFIED BLOCK DIAGRAM

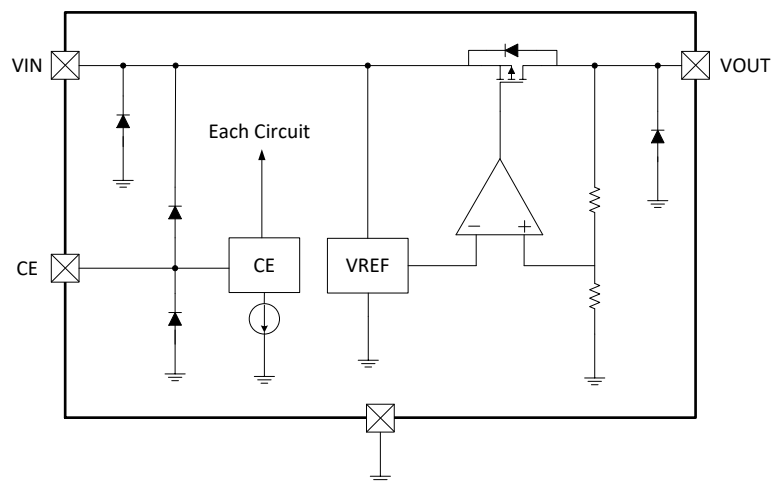

TYPICAL PERFORMANCE CHARACTERISTICS

$C_{IN}=1\mu F$, $C_{OUT}=1\mu F$, $T_{OPT}=25^{\circ}C$, $V_{IN}=5V$, $V_{OUT}=3.3V$

Line Regulation

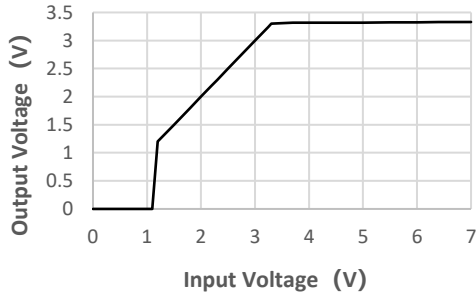

Load Regulation

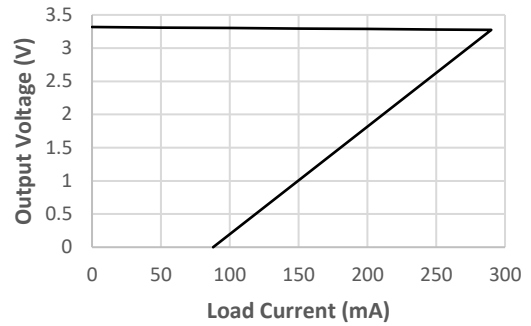

Dropout Voltage vs. Output Current

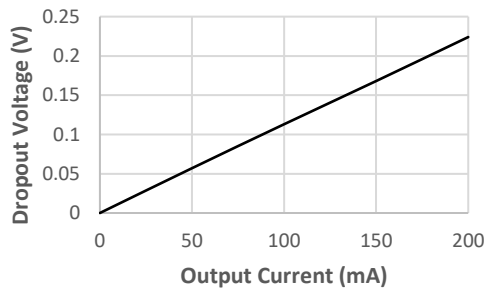

Quiescent Current vs. Input Voltage

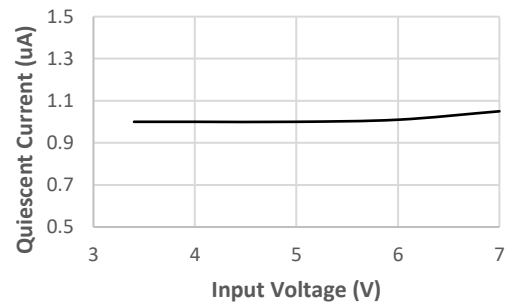

Current Limit vs. Input Voltage

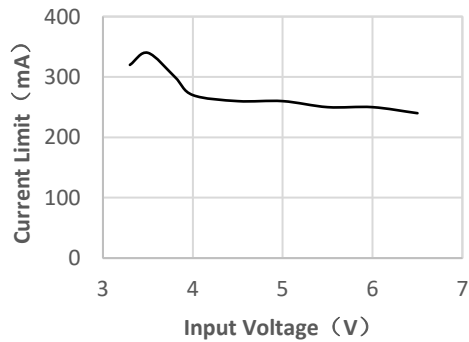

Short Current vs. Input Voltage

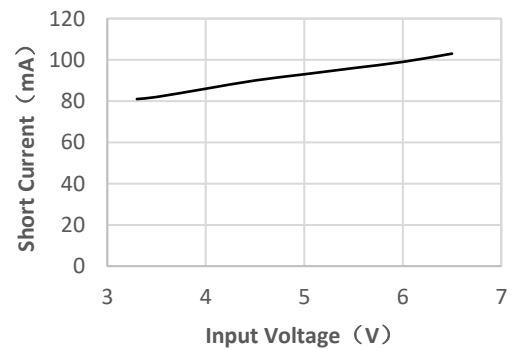

Output Voltage vs. Temperature

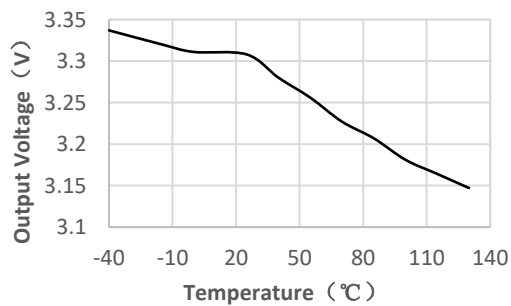

Power ON/OFF:

V_{IN} 、CE 同时上电

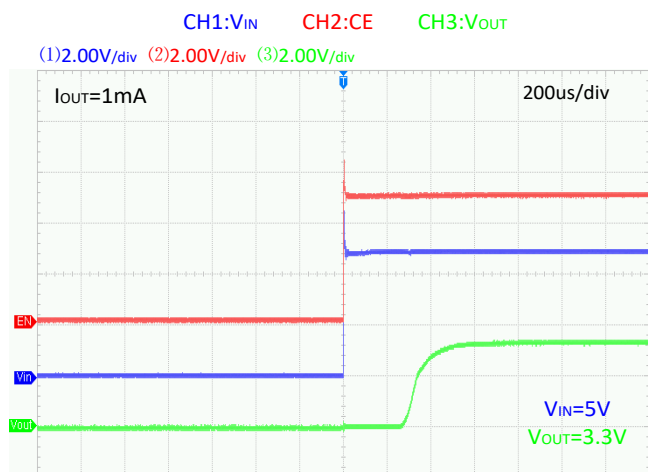

V_{IN} 、CE 同时下电

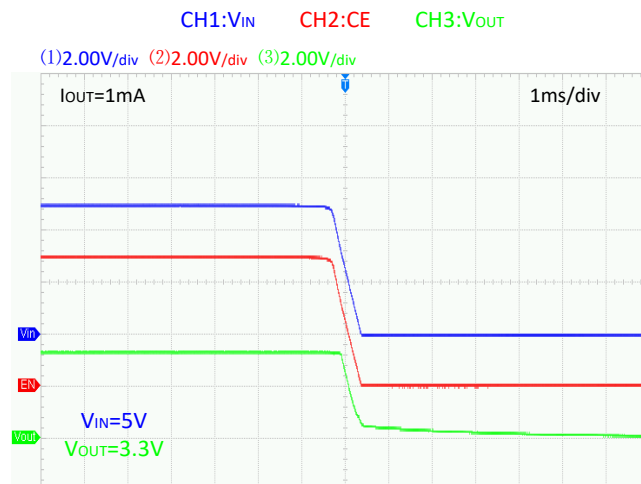

V_{IN} 上电

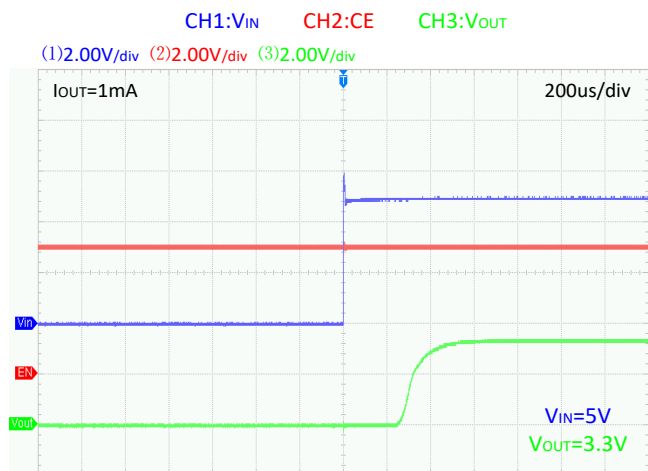

V_{IN} 下电

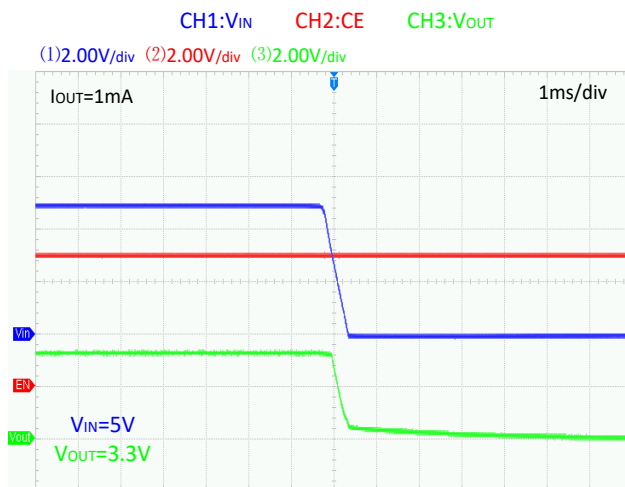

CE 上电

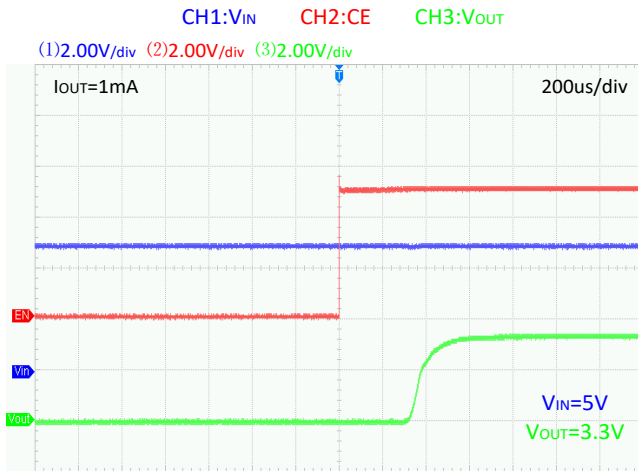

CE 下电

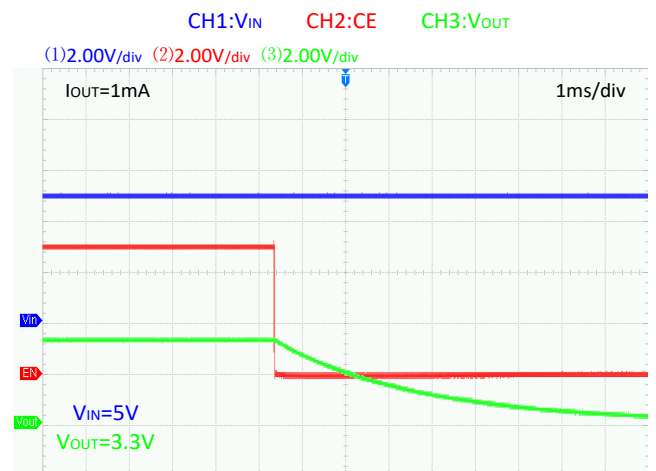

Line transient response:

$V_{IN}=4V$ to $6.5V$

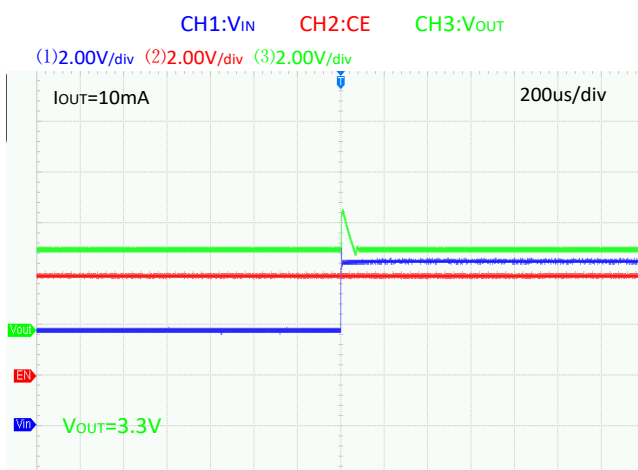

$V_{IN}=6.5V$ to $4V$

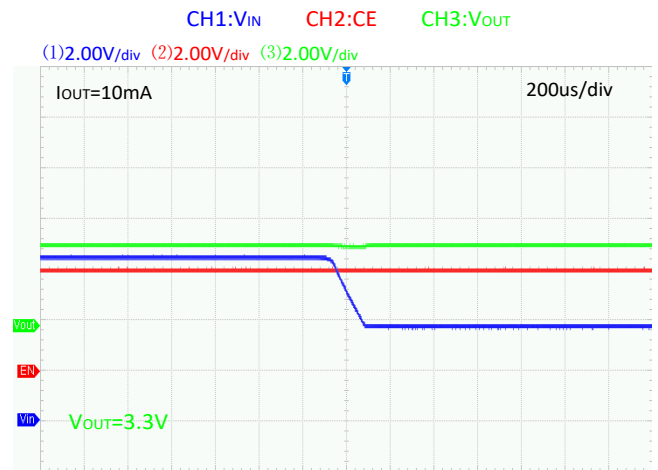

Load transient response:

$I_{OUT}=50\text{mA}$ to 200mA

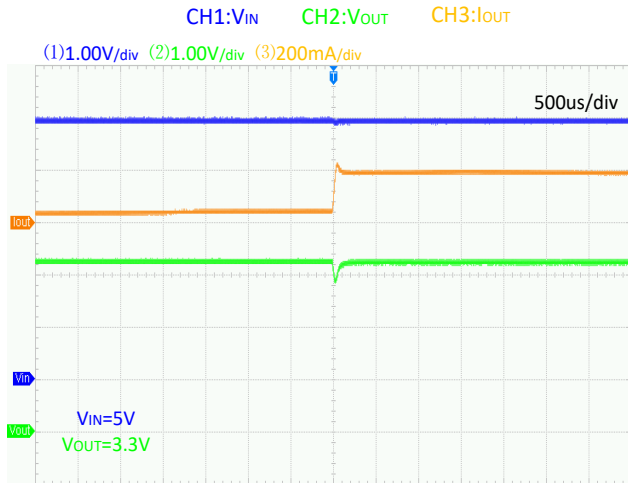

$I_{OUT}=200\text{mA}$ to 50mA

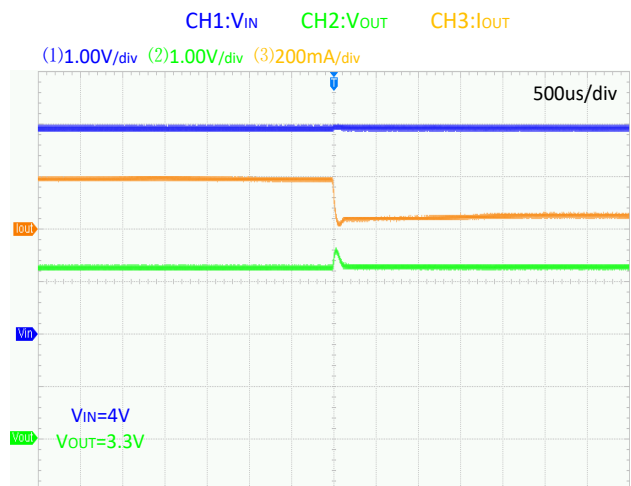
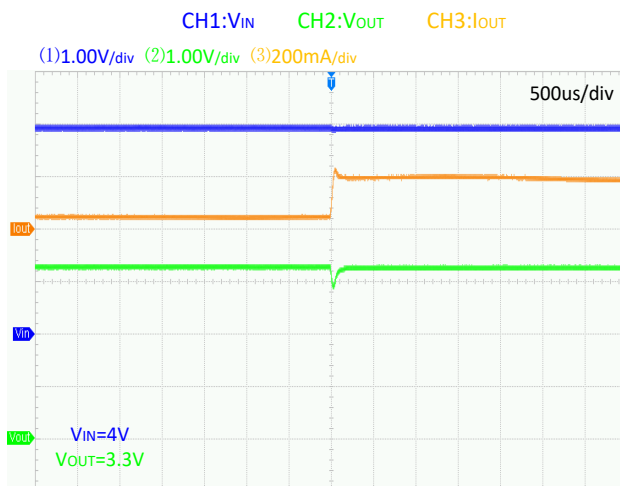
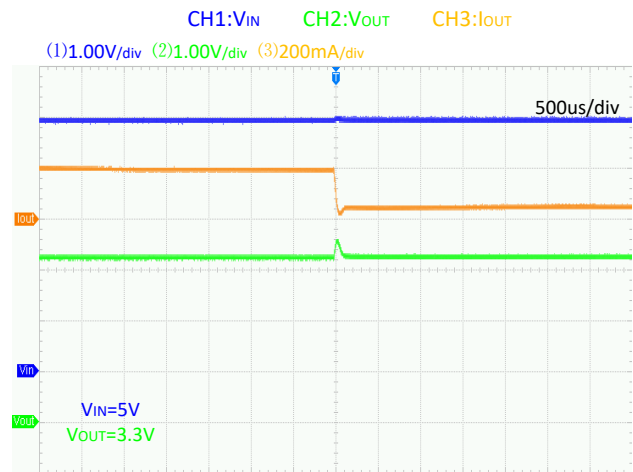

PACKAGE OUTLINE

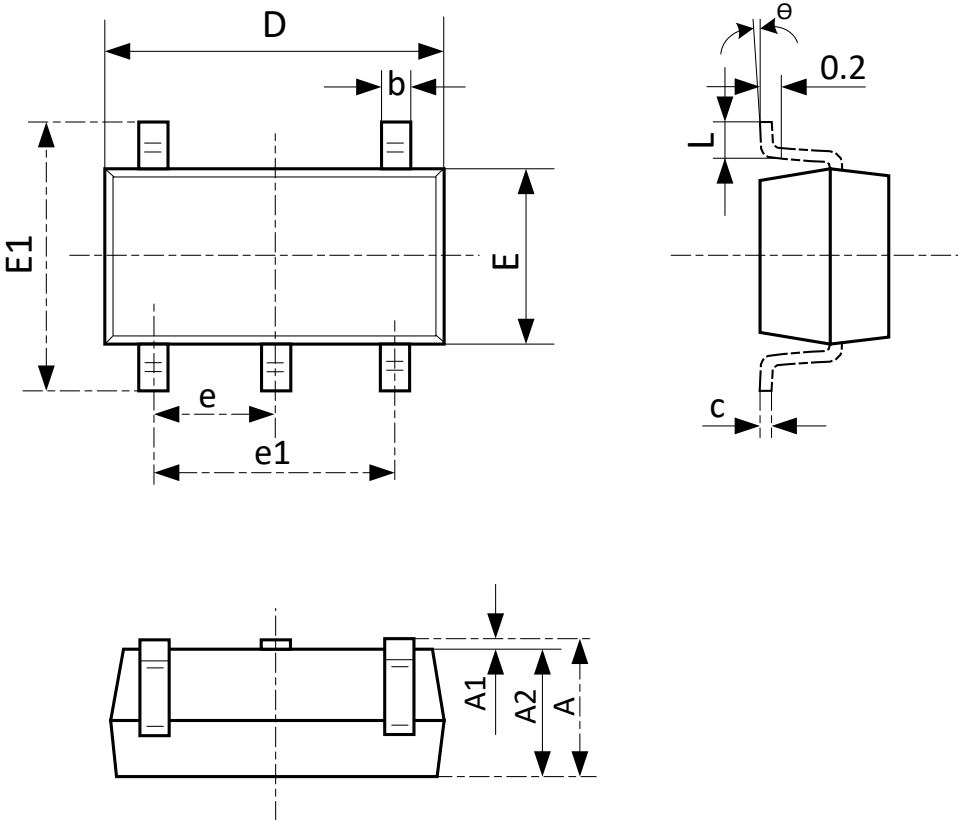
Package	SOT23-5L	Devices per reel	3000Pcs	Unit	mm
Package Dimension:					
					
Symbol	Dimensions In Millimeters		Dimensions In Inches		
	Min	Max	Min	Max	
A	1.050	1.250	0.041	0.049	
A1	0.000	0.100	0.000	0.004	
A2	1.050	1.150	0.041	0.045	
b	0.300	0.500	0.012	0.020	
c	0.100	0.200	0.004	0.008	
D	2.820	3.020	0.111	0.119	
E	1.500	1.700	0.059	0.067	
E1	2.650	2.950	0.104	0.116	
e	0.950(BSC)		0.037(BSC)		
e1	1.800	2.000	0.071	0.079	
L	0.300	0.600	0.012	0.024	
θ	0°C	8°C	0°C	8°C	

X-ON Electronics

Largest Supplier of Electrical and Electronic Components

Click to view similar products for [Linear Voltage Regulators](#) category:

Click to view products by [Suntek](#) manufacturer:

Other Similar products are found below :

[LV56831P-E](#) [LV5684PVD-XH](#) [MCDTSA6-2R](#) [L7815ACV-DG](#) [PQ3DZ53U](#) [LV56801P-E](#) [TLE42794G](#) [L78L05CZ/1SX](#) [L78LR05DL-MA-E](#) [636416C](#) [714954EB](#) [BA033LBSG2-TR](#) [LV5680P-E](#) [L78M15CV-DG](#) [TLS202B1MBV33HTSA1](#) [L79M05T-E](#) [TLS202A1MBVHTSA1](#) [L78LR05D-MA-E](#) [NCV317MBTG](#) [NTE7227](#) [LV5680NPVC-XH](#) [LT1054CN8](#) [MP2018GZD-5-Z](#) [MP2018GZD-33-Z](#) [MIC5281-3.3YMM](#) [RT9078-28GQZ](#) [MC78L06BP-AP](#) [TA48LS05F\(TE85L,F\)](#) [TA78L12F\(TE12L,F\)](#) [TC47BR5003ECT](#) [TCR2LN12,LF\(S](#) [TCR2LN28,LF\(S](#) [TCR2LN30,LF\(S](#) [TCR3DF295,LM\(CT](#) [TCR3DF40,LM\(CT](#) [BA178M20CP-E2](#) [L78M12ABDT](#) [LM7812SX/NOPB](#) [LR645N3-G-P003](#) [LR645N3-G-P013](#) [ZXTR2005P5-13](#) [SCD7812BTG](#) [TCR3DF335,LM\(CT](#) [ZXTR2012K-13](#) [TLE42994E V33](#) [ZXTR2008K-13](#) [ZXTR2005K-13](#) [LA5693D-E](#) [L88R05DL-E](#) [ADP3300ARTZ-2.7RL7](#)