

SK6054 500mA High PSRR, Ultra Low Output Voltage LDO

GENERAL DESCRIPTION

The SK6054 is a low input voltage 500mA LDO. The input voltage is as low as 1.2V. The output voltage accuracy has been improved to $\pm 2\%$ and due to a built-in transistor with low on-resistance. It consists of a voltage reference unit, an error amplifier, a resistor-net for voltage setting, and a current limit circuits for over-current prevention.

The SK6054 uses a type of outstanding CMOS process to minimize the supply current. A low on-resistance PMOS pass device is equipped for lower dropout voltage.

The SK6054 also possess the CE function to save more energy and extend the battery life. The CE pin can switch the regulator to standby mode.

The SK6054 is available in the DFN1x1-4 packages.

FEATURES

- Wide Input Voltage Range: 1.2V ~ 5.0V
- Fixed Output Voltage Range: 0.6V to 3.6V
- Maximum Output Current: 500mA
- High PSRR: 80dB @1KHz
- Very Low IQ: 55 μ A
- Output Voltage Accuracy: $\pm 2\%$
- Dropout Voltage: 140mV@300mA typ, when Vout=1.8V
- Excellent Load/Line Transient Response
- Built-in Fold Back Protection Circuit
- Built-in Constant Slope Circuit
- Built-in Auto-Discharging Circuit
- Built-in Thermal Protection Circuit

APPLICATIONS

- Constant-voltage power supply for battery-powered device
- Constant-voltage power supply for TV, notebook PC and home electric appliance
- Constant-voltage power supply for portable equipment

TYPICAL APPLICATION CIRCUITS

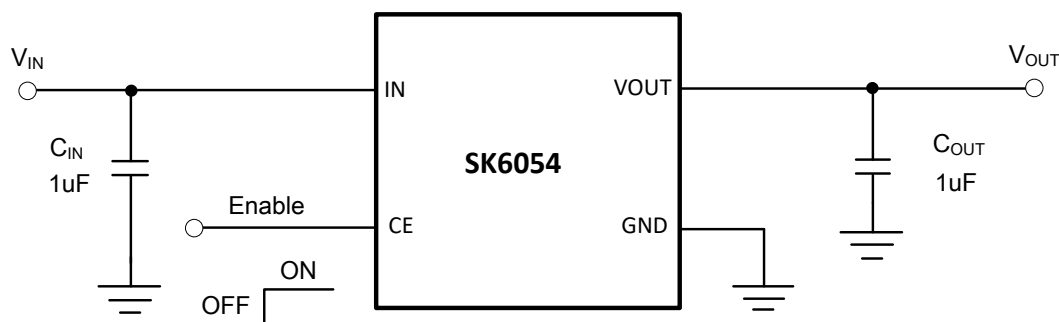

PIN CONFIGURATION

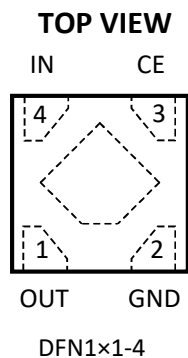

PIN DESCRIPTIONS

Pin Number	Pin Name	Description
1	VOUT	Output Pin
2	GND	Ground Pin
3	CE	Chip Enable Pin, "H" Enable
4	IN	Input Pin
-	Thermal Pad	Thermal pad, connect to GND.

ORDERING INFORMATION

Ordering Number	Package	Temperature	Tape and Reel
SK6054D4-XX	DFN1×1-4	-40°C to +85°C	10000

XX: Output voltage. Example, 18 indicate 1.8V output voltage.

ABSOLUTE MAXIMUM RATINGS^(Note 1)

Parameters	Rating	Unit
Input Voltage	-0.3 to 6.0	V
Input Voltage (CE Pin)	-0.3 to 6.0	V
Output Voltage	-0.3 to $V_{IN}+0.3$	V
Maximum Load Current	500	mA
Maximum Power Consumption	600	mW
Operating Junction Temperature	-40 to 150	°C
Storage Temperature	-65 to 150	°C
Lead Temperature (Soldering, 10 sec)	300	°C

Note (1): Stresses beyond those listed under “ABSOLUTE MAXIMUM RATINGS” may cause permanent damage to the device. These are stress ratings only, and functional operation of the device at these or any other conditions beyond those indicated in the operational sections of the specifications is not implied. Exposure to absolute maximum rating conditions for extended periods may affect device reliability.

RECOMMENDED OPERATING CONDITIONS

Symbol	Items	Rating	Unit
V_{IN}	Input Voltage	1.2 to 5.0	V
I_{OUT}	Output Current	0 to 500	mA
T_A	Operating Ambient Temperature	-40 to 85	°C
C_{IN}	Effective Input Ceramic Capacitor Value	0.47 to 10	μ F
C_{OUT}	Effective Output Ceramic Capacitor Value	0.47 to 10	μ F
ESR	Input and Output Capacitor Equivalent Series Resistance (ESR)	5 to 100	m Ω

ESD RATINGS

Symbol	Parameters	Conditions	Min	Typ	Max	Unit
HBM	ESD	Reference: ESDA/JEDEC JS-001-2017	\pm 4000			V
CDM		Reference: ESDA/JEDEC JS-002-2014	\pm 1500			V

ELECTRICAL CHARACTERISTICS

$V_{IN}=V_{OUT}+1V$, $T_A=25^{\circ}C$, $C_{IN}=C_{OUT}=1\mu F$, unless otherwise noted.

Symbol	Parameters	Conditions	Min	Typ	Max	Unit
V_{IN}	Operating Input Voltage Range		1.2		5.0	V
V_{DROP}	Dropout Voltage	$V_{OUT} = 0.6V, I_{OUT} = 500mA$		700	900	mV
		$V_{OUT} = 0.6V, I_{OUT} = 300mA$		400	600	mV
		$V_{OUT} = 0.85V, I_{OUT} = 500mA$		600	825	mV
		$V_{OUT} = 0.85V, I_{OUT} = 300mA$		360	495	mV
		$V_{OUT} = 0.9V, I_{OUT} = 500mA$		600	825	mV
		$V_{OUT} = 0.9V, I_{OUT} = 300mA$		360	495	mV
		$V_{OUT} = 1.05V, I_{OUT} = 500mA$		430	575	mV
		$V_{OUT} = 1.05V, I_{OUT} = 300mA$		255	345	mV
		$V_{OUT} = 1.1V, I_{OUT} = 500mA$		430	575	mV
		$V_{OUT} = 1.1V, I_{OUT} = 300mA$		255	345	mV
		$V_{OUT} = 1.8V, I_{OUT} = 500mA$		240	375	mV
		$V_{OUT} = 1.8V, I_{OUT} = 300mA$		140	245	mV
I_{Q_ON}	DC Supply Quiescent Current	Active mode: $V_{CE} = V_{IN}$	30	55	70	μA
I_{Q_OFF}	DC Supply Shutdown Current	$V_{CE} = 0V$		0.1	2	μA
V_{OUT}	Output Voltage	$I_{OUT} = 1mA \sim 500mA, T_A = 25^{\circ}C$	-2		2	%
		$I_{OUT} = 1mA, T_A = -40^{\circ}C \sim 85^{\circ}C$	-2.5		2.5	
Reg_{LINE}	Output Voltage Line Regulation	$V_{OUT}+1V \leq V_{IN} \leq 5V,$ $I_{OUT} = 10mA$ ($\Delta V_{OUT}/\Delta V_{IN}/V_{OUT}$)		0.10	0.25	%/V
Reg_{LOAD}	Output Voltage Load Regulation	I_{OUT} from 1mA to 500mA (ΔV_{OUT})		25	45	mV
V_{TRLN}	Line Transient (The absolute value of the output change)	$I_{OUT} = 1mA, V_{IN} = V_{OUT}+1V$ to 5V in 10us, $T_A=25^{\circ}C$		15	30	mV
		$I_{OUT} = 1mA, V_{IN} = 5V$ to $V_{OUT}+1V$ in 10us, $T_A=25^{\circ}C$		15	30	
V_{TRLD}	Load Transient (The absolute value of the output change)	$V_{IN} = V_{OUT}+1V, I_{OUT}$ from 1mA to 500mA in 10us, $T_A = 25^{\circ}C$		85	120	mV
		$V_{IN} = V_{OUT}+1V, I_{OUT}$ from 500mA to 1mA in 10us, $T_A = 25^{\circ}C$		50	120	
I_{OUT}	Output Current		500			mA
I_{LMT}	Over Current Limit	$V_{IN} = V_{OUT}+1V, T_A = 25^{\circ}C$	600	700	900	mA

ELECTRICAL CHARACTERISTICS (Continued)

$V_{IN}=V_{OUT}+1V$, $T_A=25^{\circ}C$, $C_{IN}=C_{OUT}=1\mu F$, unless otherwise noted.

Symbol	Parameters	Conditions	Min	Typ	Max	Unit
I_{SHORT}	Short Current Limit	$V_{OUT} = 0V$, $T_A = 25^{\circ}C$	70	110	180	mA
PSRR	Power Supply Rejection Ratio	$f = 1kHz$, $C_{OUT} = 1\mu F$, $I_{OUT} = 20mA$, $V_{IN} = V_{OUT}+1V$, $T_A = 25^{\circ}C$	50	80		dB
e_N	Output Noise	10Hz to 100kHz, $I_{OUT} = 30mA$, $C_{OUT} = 1\mu F$, $T_A = 25^{\circ}C$		40	70	μV_{RMS}
V_{ENL}	EN Low Threshold	$V_{IN}=1.2$ to 5V			0.4	V
V_{ENH}	EN High Threshold	$V_{IN}=1.2$ to 5V	0.9			V
I_{CE}	CE Pull-down Current	$V_{IN} = V_{CE} = V_{OUT}+1V$, $T_A = 25^{\circ}C$	0.2	0.7	1	μA
R_{LOW}	Output resistance of auto discharge at off state	$V_{EN} = 0V$, $V_{IN} = 2V$, $I_{OUT} = 10mA$	20	40	80	Ω
T_{TSD}	Thermal Shutdown Temperature	Junction Temperature		160		$^{\circ}C$
T_{TSR}	Thermal Shutdown Temperature, released	Junction Temperature		140		$^{\circ}C$

Note: Guaranteed by design and characterization.

TYPICAL CHARACTERISTICS

$V_{OUT}=1.05V$, $V_{IN}=2.05V$, $T_A=25^{\circ}C$, $C_{IN}=C_{OUT}=1\mu F$, unless otherwise noted.

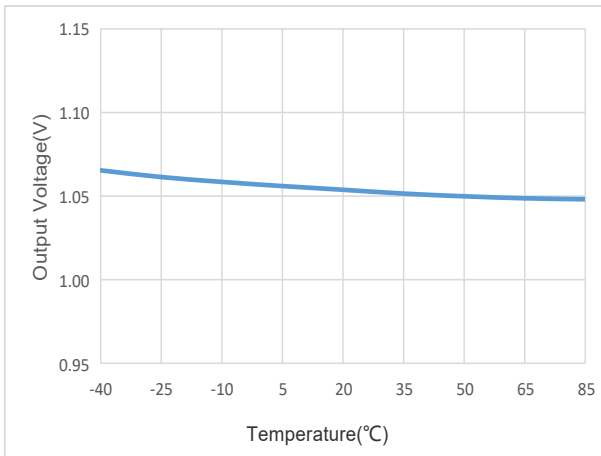

Output Voltage VS Temperature

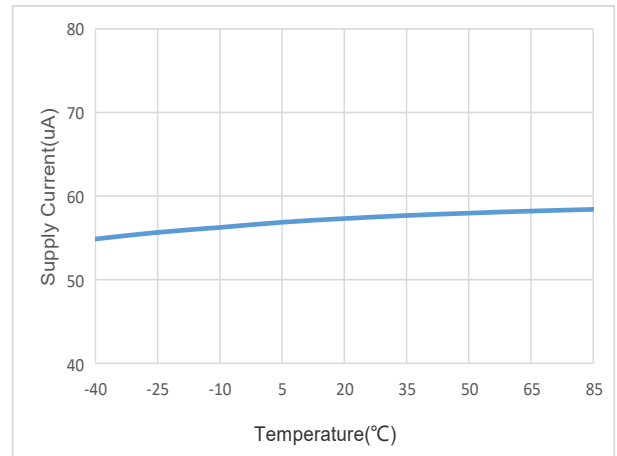

Supply Current VS Temperature

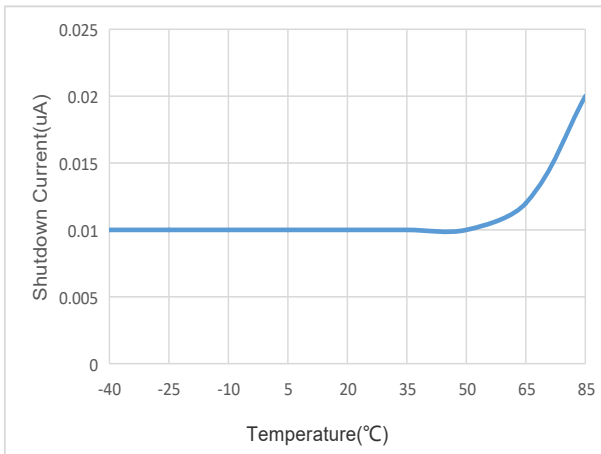

Shutdown Current VS Temperature

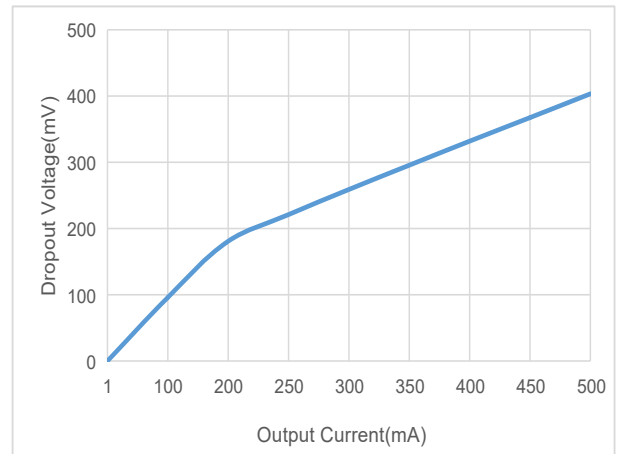

Dropout Voltage VS Output Current

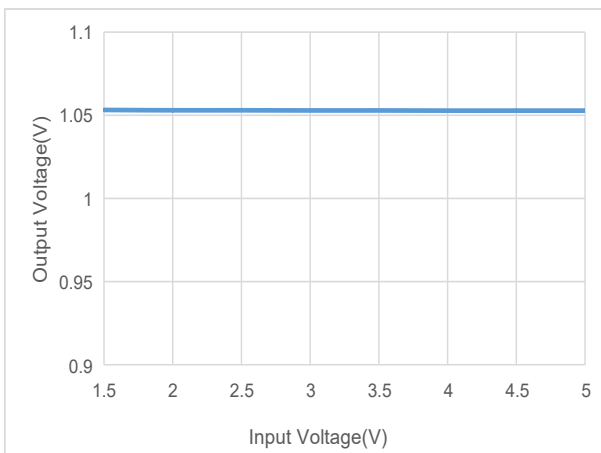

Output Voltage VS Input Voltage

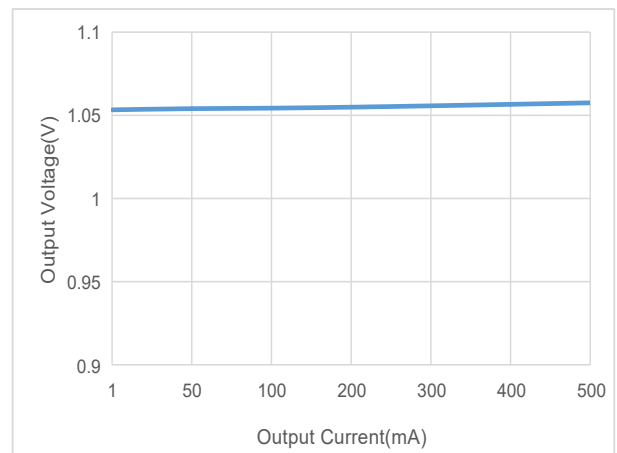

Output Voltage VS Output Current

TYPICAL CHARACTERISTICS (Continued)

$V_{OUT}=1.05V$, $V_{IN}=2.05V$, $T_A=25^{\circ}C$, $C_{IN}=C_{OUT}=1\mu F$, unless otherwise noted.

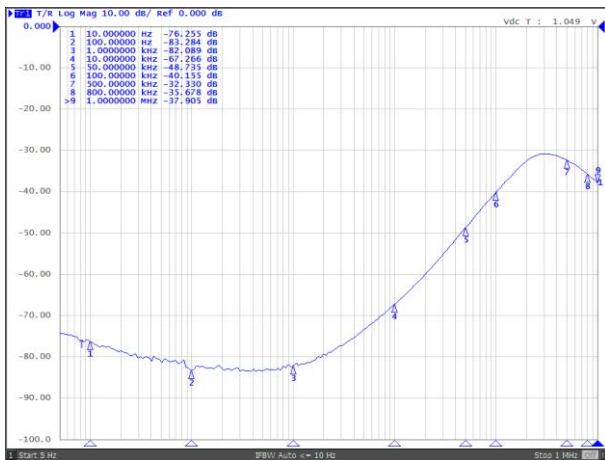

PSRR

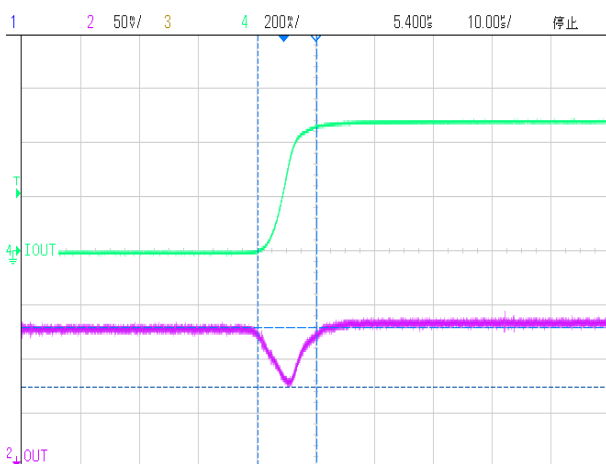

Load Transient(1mA to 500mA t=10us)

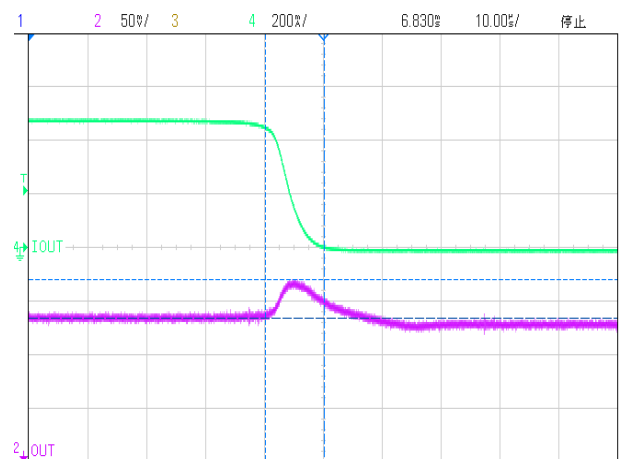

Load Transient(500mA to 1mA t=10us)

FUNCTIONAL BLOCK DIAGRAM

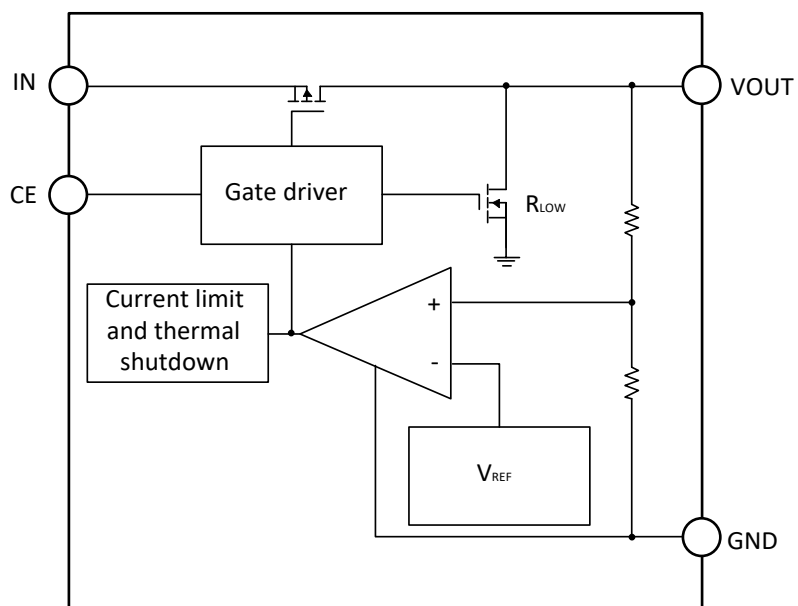

FUNCTIONAL DESCRIPTION

Input Capacitor

A 1 μ F ceramic capacitor is recommended to connect between VIN and GND pins to decouple input power supply glitch and noise. The amount of the capacitance may be increased without limit. This input capacitor must be located as close as possible to the device to assure input stability and less noise. For PCB layout, a wide copper trace is required for both VIN and GND.

Output Capacitor

An output capacitor is required for the stability of the LDO. The recommended output capacitance is 0.47 μ F to 10 μ F (usually 1 μ F), Equivalent Series Resistance (ESR) is from 5m Ω to 100m Ω . ceramic capacitor is recommended, and temperature characteristics are X7R or X5R. Higher capacitance values help to improve load/line transient response. The output capacitance may be increased to keep low undershoot/overshoot. Place output capacitor as close as possible to OUT and GND pins.

CE Pin Operation

The SK6054 is turned on by setting the CE pin to “H”. Since the CE pin is neither pulled down nor pulled up internally, do not set it in floating status. When the CE pin is not used, connect the CE pin with IN pin to keep the LDO in operating mode.

Current Limit Protection

When output current of OUT pin is higher than current limit threshold or the OUT pin is direct short to GND, the current limit protection will be triggered and clamp the output current at a pre-designed level to prevent over-current and thermal damage.

Auto Discharging

When the CE pin set to “L”, the output circuit will be disable immediately, and the Auto-Discharging circuit will be turned on to discharge the electric charge on output capacitor, and decrease the voltage of OUT in very short time.

Thermal Shutdown Protection

Thermal protection disables the output when the junction temperature rises to approximately +160°C, allowing the device to cool down. When the junction temperature reduces to approximately +140°C the output circuit is enabled again. Depending on power dissipation, thermal resistance, and ambient temperature, the thermal protection circuit may cycle on and off. This cycling limits the heat dissipation of the regulator, protecting it from damage due to overheating.

PACKAGE DIMENSION: DFN1×1-4

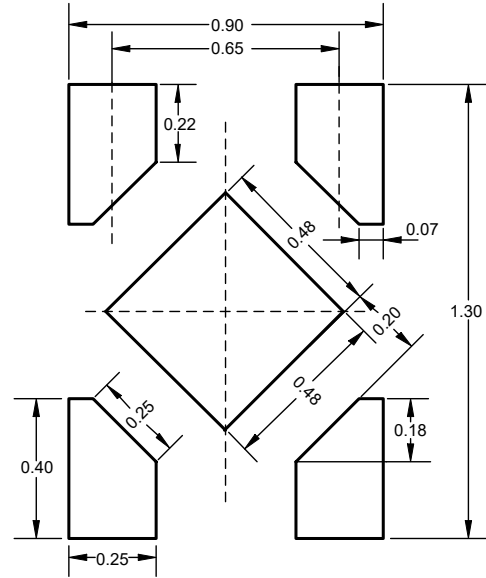
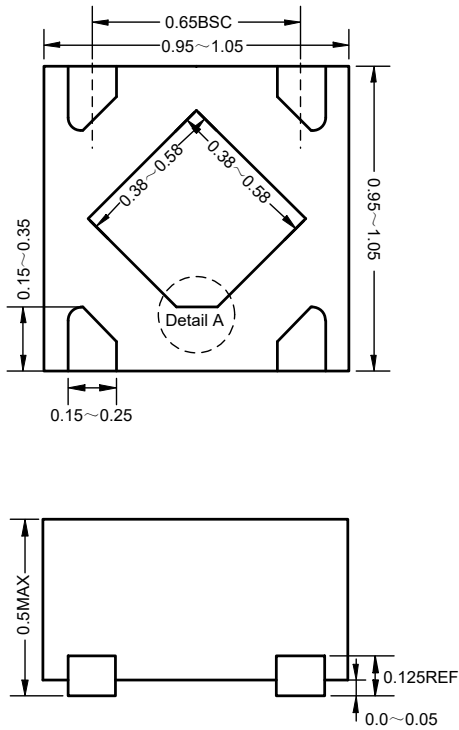

Recommended Land Pattern

Detail A: (PIN1 shape)

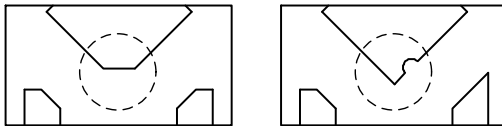

Unit: mm

X-ON Electronics

Largest Supplier of Electrical and Electronic Components

Click to view similar products for [Linear Voltage Regulators](#) category:

Click to view products by [Suntek](#) manufacturer:

Other Similar products are found below :

[LV5684PVD-XH](#) [MCDTSA6-2R](#) [L7815ACV-DG](#) [714954EB](#) [ZMR500QFTA](#) [BA033LBSG2-TR](#) [LV5680P-E](#) [L79M05T-E](#) [L78LR05D-MA-E](#) [NCV317MBTG](#) [NTE7227](#) [MP2018GZD-33-P](#) [MP2018GZD-5-P](#) [LV5680NPVC-XH](#) [LT1054CN8](#) [UA78L09CLP](#) [UA78L09CLPR](#) [CAT6221-PPTD-GT3](#) [MC78M09CDTRK](#) [NCV51190MNTAG](#) [78M05](#) [HT7150-1](#) [UM1540DB-18](#) [XC6234H281VR-G](#) [WL2834CA-6/TR](#) [TPL730F33-5TR](#) [TLS850F1TA](#) [V50](#) [TPS549B22RVFR](#) [UM1540DB-33](#) [WL9200P3-50B](#) [WL9100P3-33B](#) [XC6219B152MR](#) [WL2855K33-3/TR](#) [PJ54BM33SE](#) [PJ9500M25SA](#) [MD7218E33PC1](#) [H7533-2PR](#) [SK7812AU](#) [SD1A30](#) [78L33](#) [TP78L33T3](#) [SK6513ST3A-50](#) [SK6054D4-09](#) [SK6054D4-18](#) [SK6054D4-11](#) [SK6054D4-10](#) [LM79L12F](#) [HLP2985AIM5X-5.0](#) [HLP2992AIM5X-5.0/NOPB](#) [HMIC5205-5.0YM5-TR](#)