

SUL60005

Low Noise High PSRR 1 Ch 500mA, Ultra Low Dropout LDO

GENERAL DESCRIPTION

The SUL60005 series is a CMOS-based positive low-dropout linear regulator (LDO) featuring 500 mA that provides high PSRR, high output voltage accuracy, low-noise and low supply current

It consists of a voltage reference, an error amplifier, a resistor-ladder for output voltage setting. It also has under-voltage lockout (UVLO), over current/short circuit protection circuit and over temperature shutdown circuit.

The SUL60005 typically has 50mV dropout voltage (SOT23-5, I_{out}=500mA, V_{out}=3.3V) and chip enable function (EN) for long battery life.

Excellent ripple rejection, load transient and line transient response make it ideal for the power sources of mobile communication devices or camera modules in low light condition. It can also turn on under full load condition, making it suitable for harsh system environment.

MAIN FEATURES

- Supply Current (no load) : 85μA (typ.)
- Supply Current (Standby) : 0.1μA (typ.)
- Dropout Voltage: 50mV (SOT23-5, I_{out}=500mA, V_{out}=3.3V, typ.)
- High-PSRR: 85dB @1kHz
- Output Noise: 10μV_{rms} (10-100KHz, 0.85V output voltage settings, typ.)
- Line Regulation: 0.01%/V
- Fixed Mode Voltage Range: 0.85V to 4.3V (0.05V step).
- Adjustable Mode Voltage Range: 0.85V to 4.6V.
- Built-in Short Current Protection Limit: 120mA
- Built-in Peak Current Protection Limit: 0.85A
- Over Temperature Protection and Auto Recover
- Built-in Soft-Start and Inrush Current Limit
- Fast Auto Discharge Function for Power Down

APPLICATIONS

- Portable Device , Tablets and Smartphone
- Cameras, VCRs and Car Dash Cameras
- Low Light & Low Noise Cam Application
- Communications and Infrastructure
- AR or VR Application

BLOCK DIAGRAMS

SOT-23-5 Fixed Mode (5 PIN)

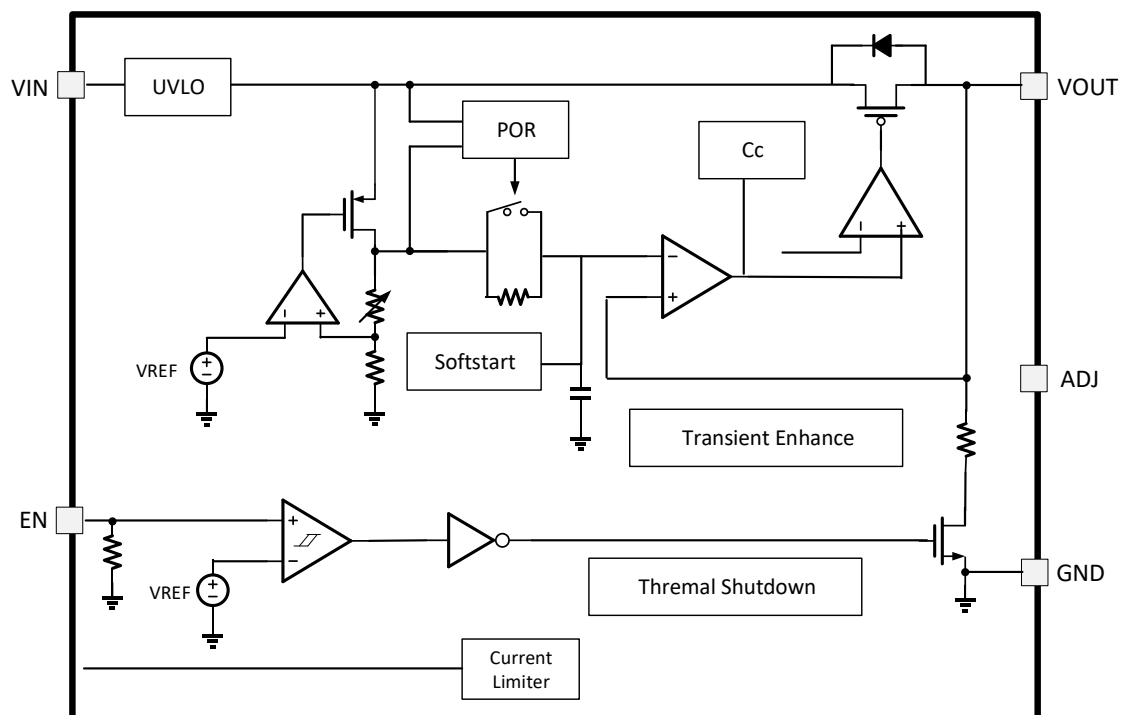

SOT-23-5 ADJ Mode (5 PIN)

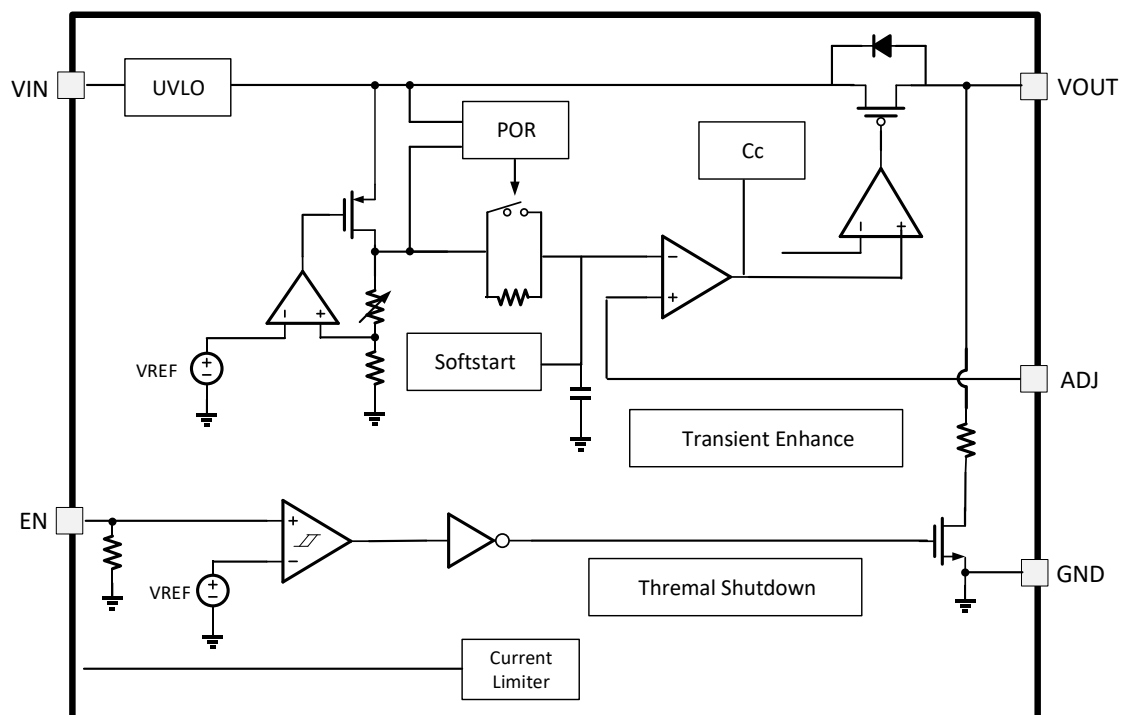

PACKAGE INFORMATION & PIN DESCRIPTION

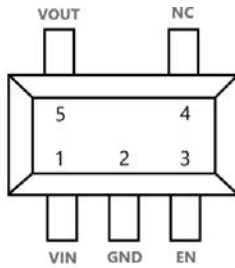

SOT-23-5 Pin Configuration (Fixed Mode)

PIN No	Symbol	Pin Description
1	VIN	Input Pin
2	GND	Ground Pin
3	EN	Chip Enable Pin
4	NC	No Connection
5	VOUT	Output Pin

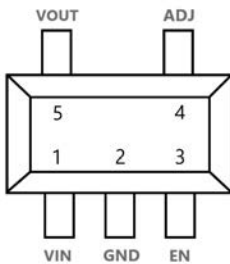

SOT-23-5 Pin Configuration (ADJ Mode)

PIN No	Symbol	Pin Description
1	VIN	Input Pin
2	GND	Ground Pin
3	EN	Chip Enable Pin
4	ADJ	ADJ Pin. In Adjustable mode, this is used to set VOUT
5	VOUT	Output Pin

Ordering Information

Part Number	Package	Tape&Reel
SUL60005S5-XX	SOT23-5	3000/Reel

TYPICAL APPLICATION CIRCUIT

A. Fixed mode example

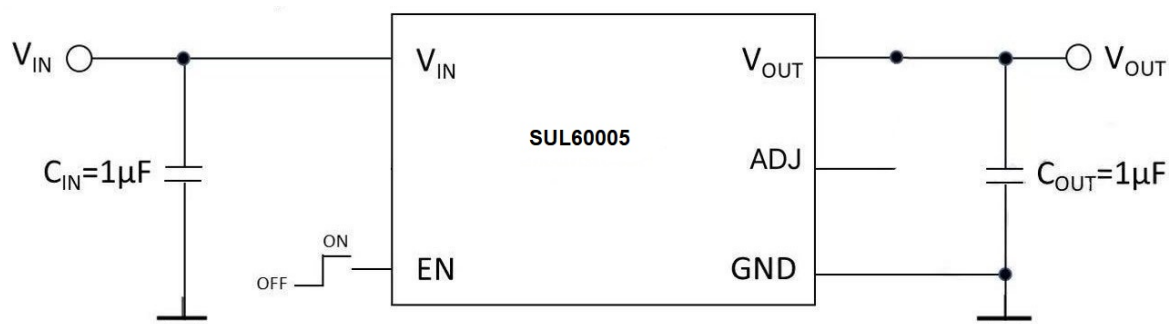

* Recommended Ceramic Capacitors for V_{IN} and V_{OUT} : 1µF

B. Adjustable (ADJ) mode example

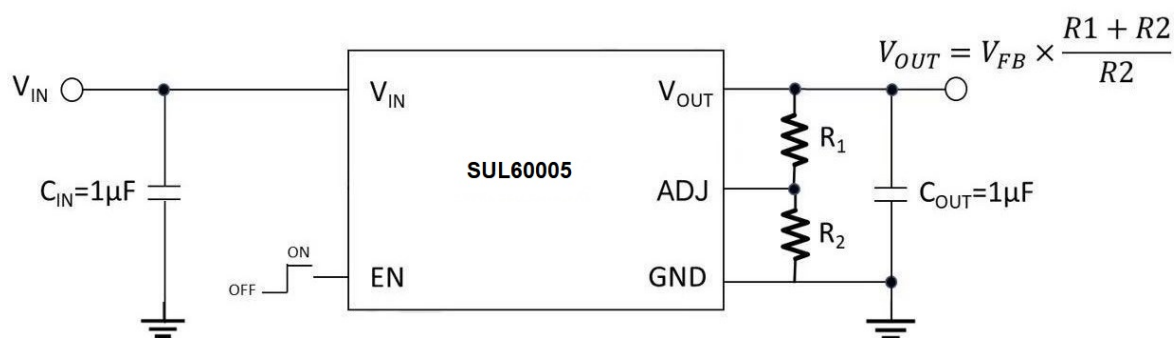

The adjustable-version device requires external feedback divider resistors to set the output voltage. V_{OUT} is set using the feedback divider resistors, R_1 and R_2 , according to the following equation:

$$V_{OUT} = V_{FB} \times (1 + R_1 / R_2)$$

For this device, $V_{FB} = 0.85$ V.

To ignore the FB pin current error term in the V_{OUT} equation, set the feedback divider current to 100x the FB pin current listed in the *Electrical Characteristics* table. This setting provides the maximum feedback divider series resistance, as shown in the following equation:

$$R_1 + R_2 \leq V_{OUT} / (I_{FB} \times 100)$$

For this device, $I_{FB} = 10$ nA.

ABSOLUTE MAXIMUM RATINGS

Symbol	Item	Rating	Unit
V_{IN}	Input Voltage	6.0	V
V_{CE}	Input Voltage (CE Pin)	-0.3 to 6.0	V
V_{LCON}	Input Voltage (LCON Pin)	-0.3 to 6.0	V
V_{OUT}	Output Voltage	-0.3 to 6.0	V
P_D	Power Dissipation (Standard Land Pattern)	400	mW
T_{OP}	Junction Temperature Range	-40 to 125	°C
T_{STG}	Storage Temperature Range	-55 to 125	°C

RECOMMENDED OPERATING CONDITIONS

Symbol	Item	Rating	Unit
V_{IN}	Input Voltage	1.32 to 5.5	V
V_{OUT}	Output Voltage	0.85 to 4.3	V
T_a	Operating Temperature Range	-40 to 85	°C
C_{IN}/C_{OUT}	Input/Output Capacitance	1/1	uF

Symbol	Parameter	Value	Unit
ESD	Human Body Mode	± 4	kV
	Machine Mode	± 250	V
	Charge Device Mode	± 1000	V

THERMAL DATA

Symbol	Parameter	Value	Unit
θ_{JA}	Thermal resistance junction-ambient	80	°C/W

ELECTRICAL CHARACTERISTICS

$V_{IN} = V_{OUT} + 1.0\text{ V}$, $I_{OUT} = 1\text{ mA}$, $C_{IN} = C_{OUT} = 1.0\text{ }\mu\text{F}$, typical values are at $T_J = 25\text{ }^\circ\text{C}$; unless otherwise noted.

Symbol	Parameter	Conditions	Min.	Typ.	Max.	Unit	
V_{IN}	Operating input voltage		1.32		5.50	V	
V_{OUT}	V_{OUT} accuracy	$V_{OUT} + 0.5\text{ V} \leq V_{IN} \leq 5.5\text{ V}$	$V_{OUT} \geq 1.75\text{ V}$	-1.0	+1.0	%	
			$V_{OUT} < 1.75\text{ V}$	-20	+20	mV	
ΔV_{OUT}	Static line regulation			0.01		%/V	
ΔV_{OUT}	Static load regulation	$I_{OUT} = 10\text{ mA to } 500\text{ mA}$		1	20	mV	
V_{DROP}	Dropout voltage	$I_{OUT} = 500\text{ mA}$ For SOT-23-5	$V_{OUT}=1.2\text{ V}$		150	210	mV
			$V_{OUT}=1.8\text{ V}$		80	135	
			$V_{OUT}=2.5\text{ V}$		60	100	
			$V_{OUT}=3.3\text{ V}$		50	105	
			$V_{OUT}=4.3\text{ V}$		40	85	
I_Q	Quiescent current	$I_{OUT} = 0\text{ mA}$		85	140	μA	
$I_{Standby}$	Standby current	V_{IN} input current in OFF MODE: $V_{EN} = \text{GND}$		0.1	3	μA	
I_{LIM}	Output current limit	$I_{OUT} = 500\text{ mA}$	0.6	0.78		A	
I_{SC}	Short-circuit current	$V_{OUT} = 0\text{ V}$			186	mA	
I_{FB}	Feedback pin current			0.01	0.1	μA	
e_N	Output noise voltage			10		μVrms	
PSRR	Power Supply Rejection Ratio	$I_{OUT} = 10\text{ mA}$, $f = 1\text{ kHz}$		85		dB	
T_{TSD}	Thermal shutdown	Shutdown, temperature increasing		165		$^\circ\text{C}$	
		Reset, temperature decreasing		135		$^\circ\text{C}$	
CE	Enable input logic low	$V_{IN} = 1.32\text{ V to } 5.5\text{ V}$			0.4	V	
	Enable input logic high	$V_{IN} = 1.32\text{ V to } 5.5\text{ V}$	1				
LCON	LCON input logic low	$V_{IN} = 1.32\text{ V to } 5.5\text{ V}$			0.4	V	
	LCON input logic high	$V_{IN} = 1.32\text{ V to } 5.5\text{ V}$	1				

Load Regulation (Dynamic)

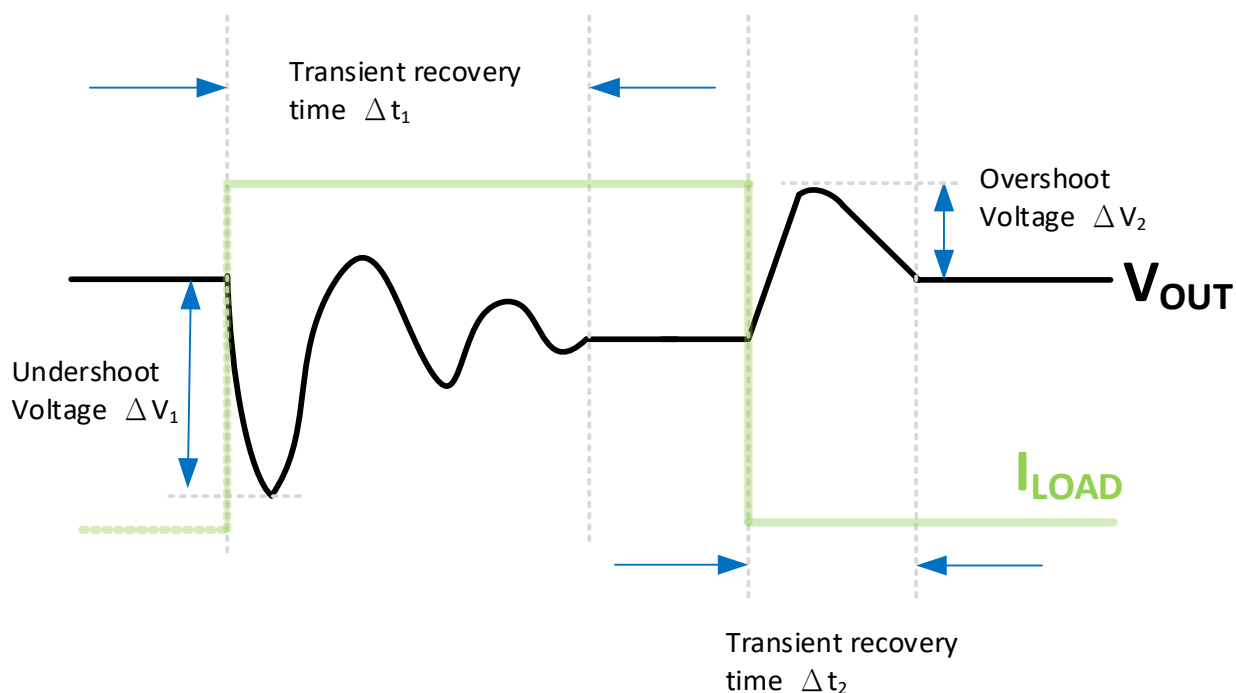

Symbol	Parameter	Condition	Min.	Typ.	Max.	Unit
ΔV_1	Undershoot Voltage	$I_{LOAD}=1mA\sim 250mA$		30		mV
		$I_{LOAD}=1mA\sim 500mA$		40		
ΔV_2	Overshoot Voltage	$I_{LOAD}=1mA\sim 250mA$		28		mV
		$I_{LOAD}=1mA\sim 500mA$		40		

Symbol	Parameter	Condition	Min.	Typ.	Max.	Unit
Δt_1	Transient recovery time	$I_{LOAD}=1mA\sim 250mA$		10		μS
		$I_{LOAD}=1mA\sim 500mA$		16		
Δt_2	Transient recovery time	$I_{LOAD}=1mA\sim 250mA$		12		μS
		$I_{LOAD}=1mA\sim 500mA$		12		

FUNCTION DESCRIPTION

A. Short-Circuit Protect and Current Limitation

SUL60005 series LDOs can protect internal circuit under short-circuit condition on the output. When the load current increases above 0.85 A, the current limit and current foldback mechanism starts to restrict the I_{LIM} value. If the load resistance decreases even more then the foldback, circuit starts limiting the current to 0.2 A when $V_{OUT} = 0$.

B. Over Temperature Protection and Auto Recover

In order to prevent over thermal condition from damaging the device, SUL60005series LDOs have internal thermal limiting functions designed to protect the device. It will rapidly shut off PMOS pass element during over temperature condition.

C. Current Foldback

The current limiting/ current foldback circuit plays an important role by controlling any excessive output current. Our SUL60005 series LDOs provide a current foldback circuit that can detect accurately when an over-current condition occurs.

D. Very Fast Transient Response

In addition to the main feedback loop, SUL60005 series LDOs contain a fast-transient loop that allows the LDO to respond faster to large-output transients. SUL60005 series LDOs that contain this loop are better able to minimize the effects of a load transient even the output capacitance is small. The recommended output capacitance value is 1 μ F. It's small size greatly reduce the cost and save PCB area.

E. Ultra High PSRR and Extreme Low Noise

Gutschsemi's SUL60005 series high-performance LDO regulators feature remarkable power supply rejection ratio characteristics (85 dB at 1kHz) and extreme-low noise operation (as low as 6.3 μ V_{RMS} with A-wt) resulting in cleaner and stable output voltages. Our LDO is very suitable for ultra-sensitive loads like camera module and security monitor, especially in low light condition.

F. Start-Up at Full Load

SUL60005 series LDOs can start-up at full load, make it very suitable for heavy load start up condition and severe system timing constraint.

G. Auto Discharge Function

SUL60005 series LDOs have an auto discharge function to quickly force the output voltage to zero. When the LDO is disabled, the auto discharge function quickly discharge the output capacitor, thereby reducing the output voltage to nearly zero. This function is very useful for quickly ON/OFF application.

H. Low Quiescent Current

SUL60005 series LDOs consume only 85 μ A (typical) while operating with no load condition. By reducing the quiescent current, your application can stay in standby/sleep mode much longer than leading low quiescent current LDOs in the market.

I. Under Voltage Lock OUT (UVLO)

SUL60005 has an undervoltage lockout (UVLO) function to make sure that whole circuit does nothing until the power supply voltage is high enough. When power supply voltage is high enough, reference circuit can generate right voltage ; logic function can generate correct control signals. This UVLO function can guarantee robust system performance.

TYPICAL CHARACTERISTICS

$V_{IN} = V_{SET}^{(1)} + 1.0\text{ V}$, $I_{OUT} = 1\text{ mA}$, $C_{IN} = C_{OUT} = 1.0\text{ }\mu\text{F}$, $L_{CON} = 'H'$, typical values are at $T_J = 25\text{ }^\circ\text{C}$; unless otherwise noted.

Output Voltage vs. Input Voltage ($C_{IN} = C_{OUT} = 1.0\text{ }\mu\text{F}$, $T_a = 25\text{ }^\circ\text{C}$)

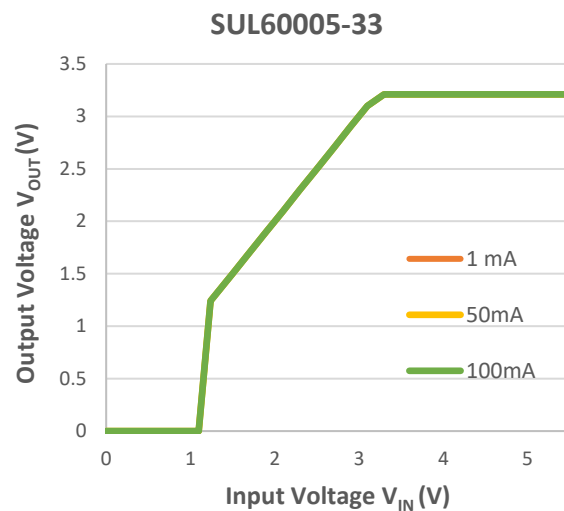
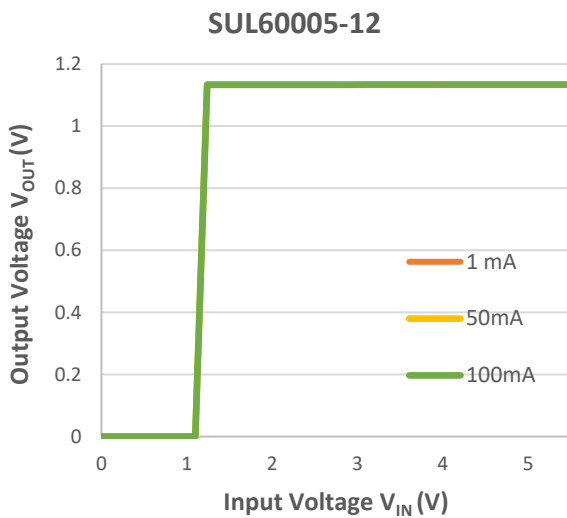

Supply Current vs. Input Voltage ($C_{IN} = C_{OUT} = 1.0\text{ }\mu\text{F}$, $T_a = 25\text{ }^\circ\text{C}$)

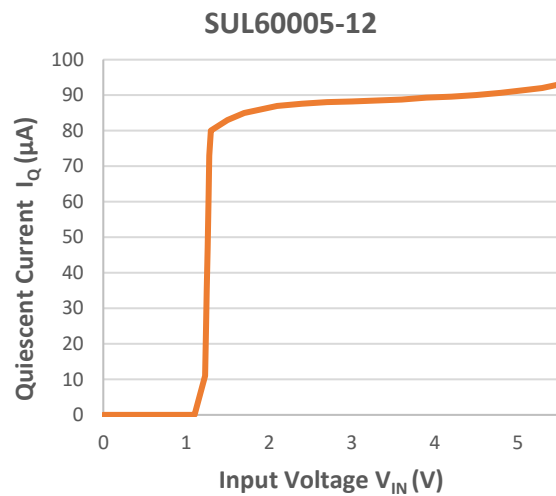
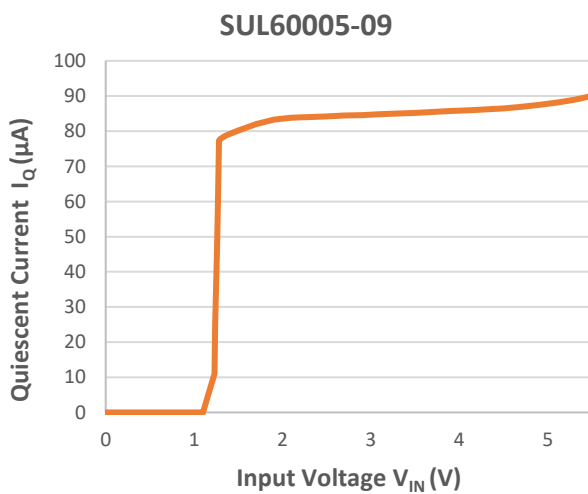

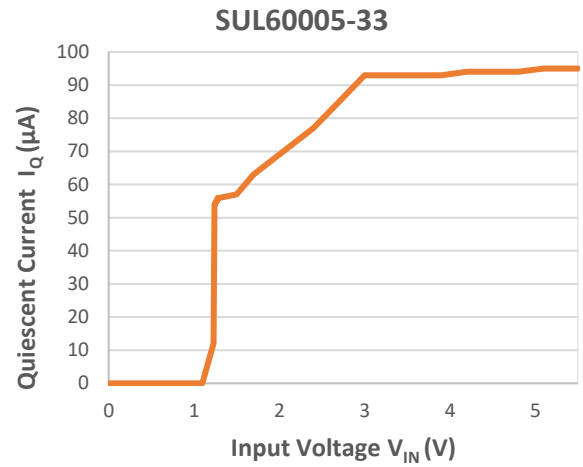
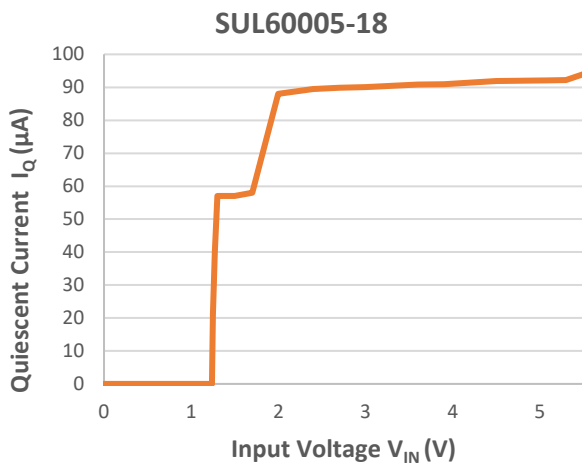

Supply Current vs. Temperature (CIN = COUT = 1.0 μ F, IOU= 0 mA)

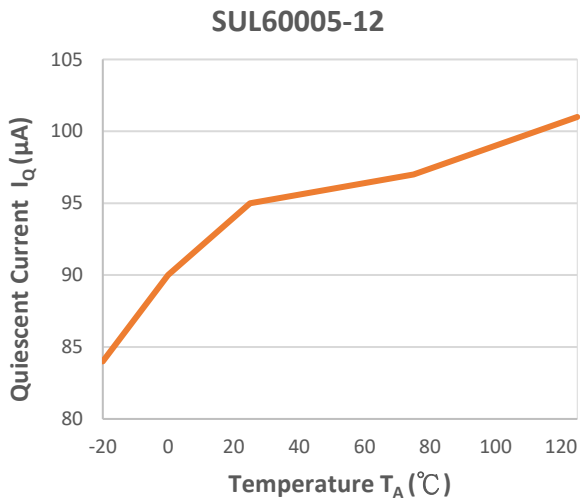

Output Noise Voltage (10 Hz to 100 kHz, $C_{IN} = C_{OUT} = 1.0 \mu F$, $T_a = 25^\circ C$)

SUL60005-09, $I_{OUT} = 100 \text{ mA}$

Amplitude Spectral Density

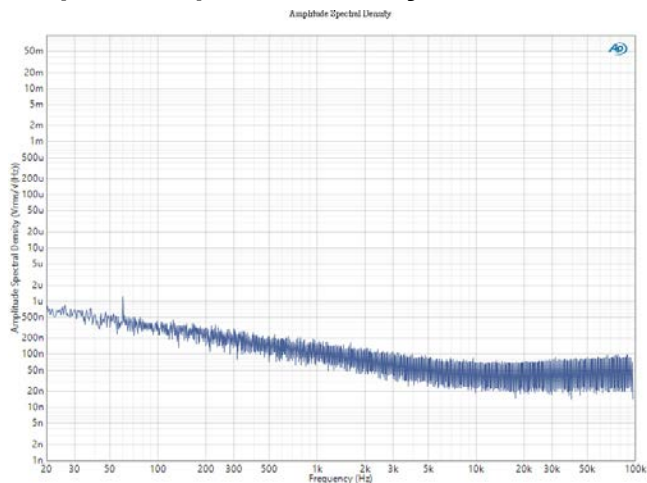

V_{RMS} from 10 Hz to 100 kHz

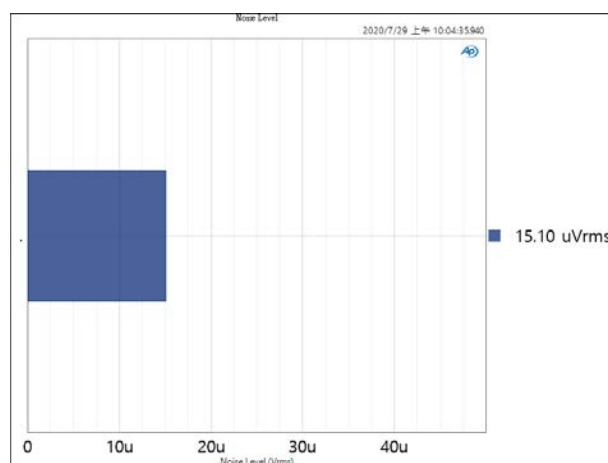

SUL60005-12, $I_{OUT} = 100 \text{ mA}$

Amplitude Spectral Density

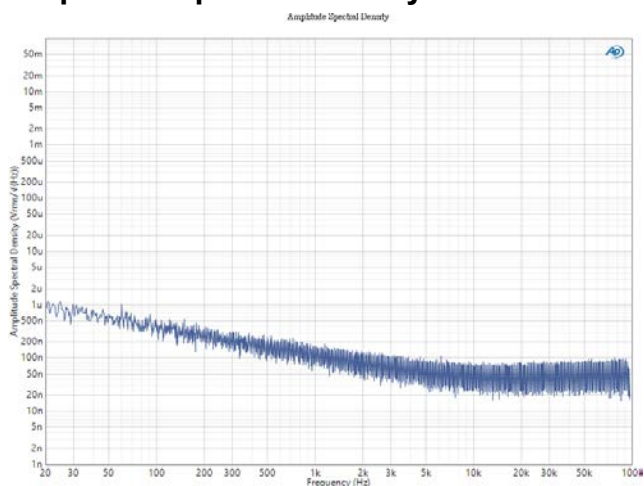

V_{RMS} from 10 Hz to 100 kHz

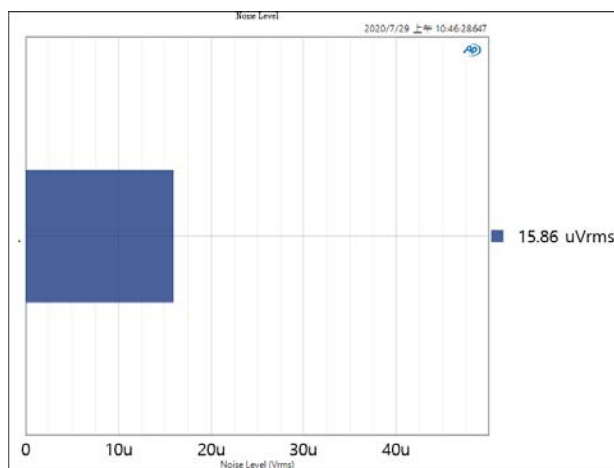

SUL60005-33, $I_{OUT} = 100\text{ mA}$

Amplitude Spectral Density

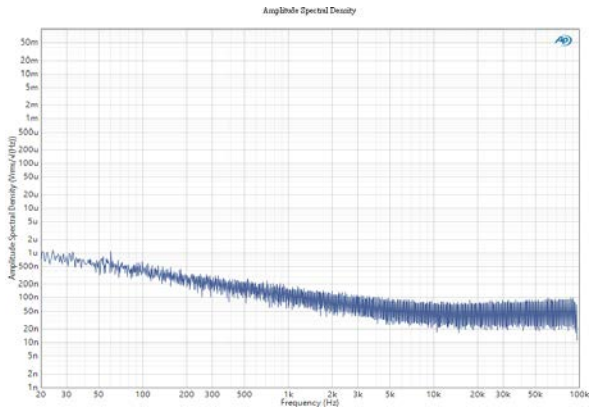

V_{RMS} from 10 Hz to 100 kHz

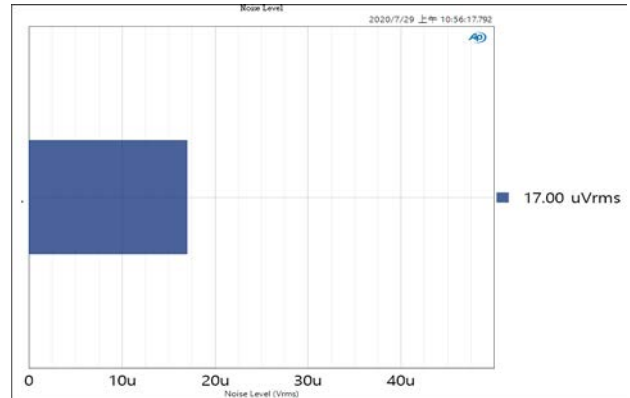

Power Supply Ripple Rejection vs. Frequency ($V_{IN}=V_{OUT}+1V$, $C_{IN} = C_{OUT} = 1.0\ \mu F$, Ripple = 0.2 Vp-p , $T_a = 25^\circ\text{C}$)

SUL60005-09

$I_{Load}=1\text{mA}$

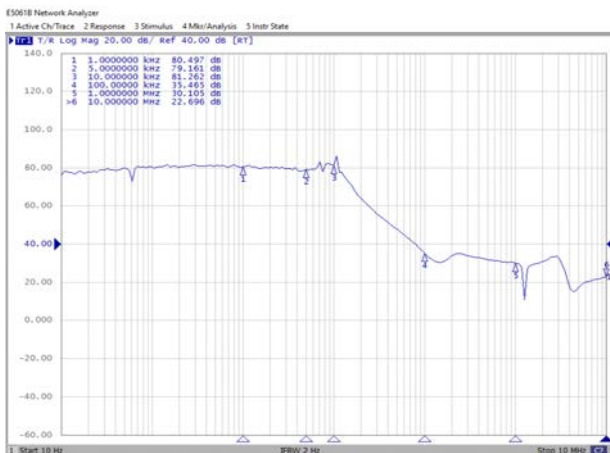

$I_{Load}=10\text{mA}$

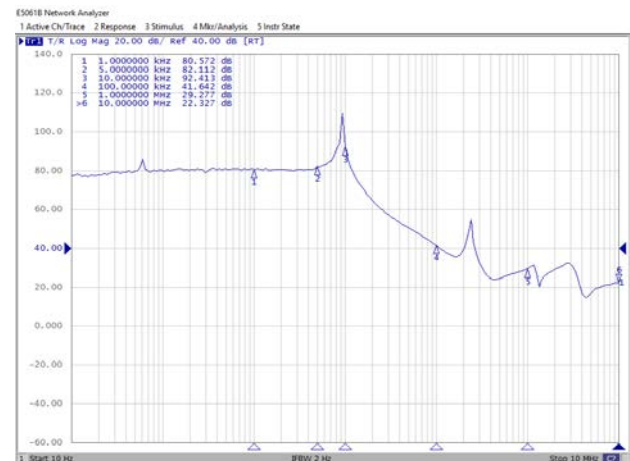

$I_{Load}=30\text{mA}$

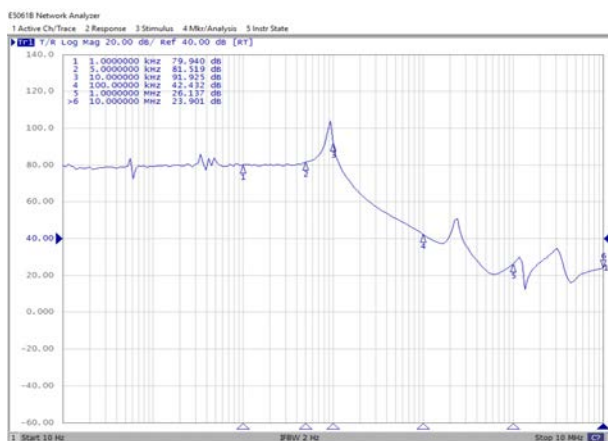

$I_{Load}=150\text{mA}$

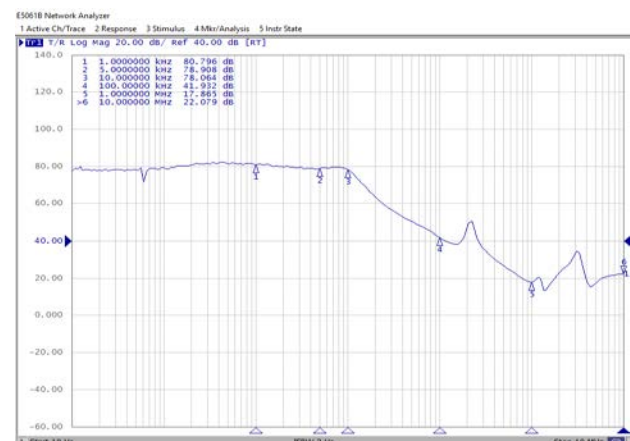

SUL60005-12

I_{Load}=1mA

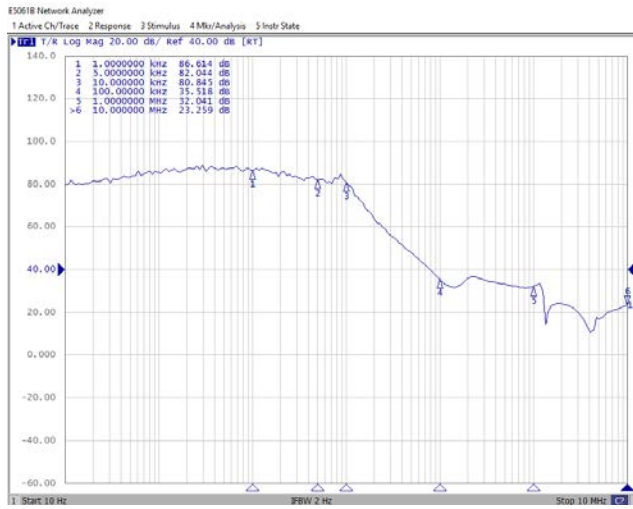

I_{Load}=10mA

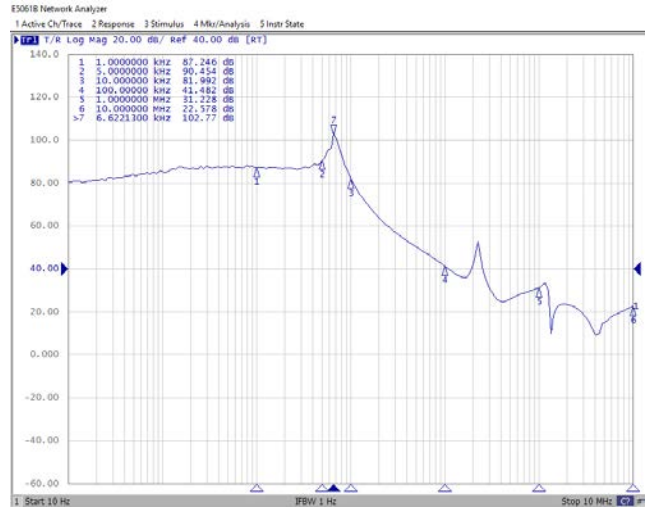

I_{Load}=30mA

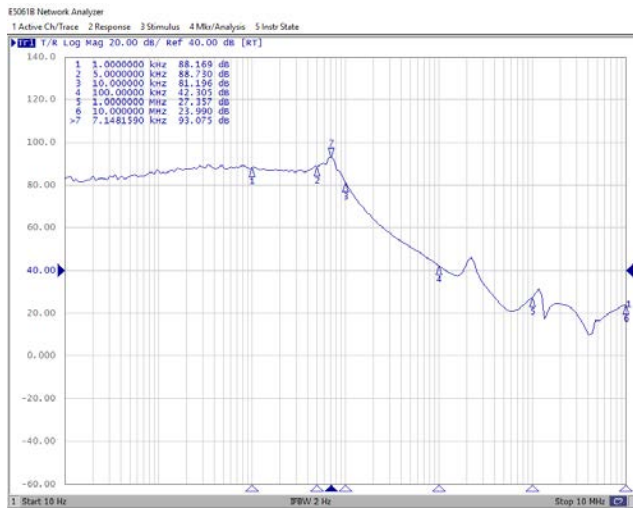

I_{Load}=150mA

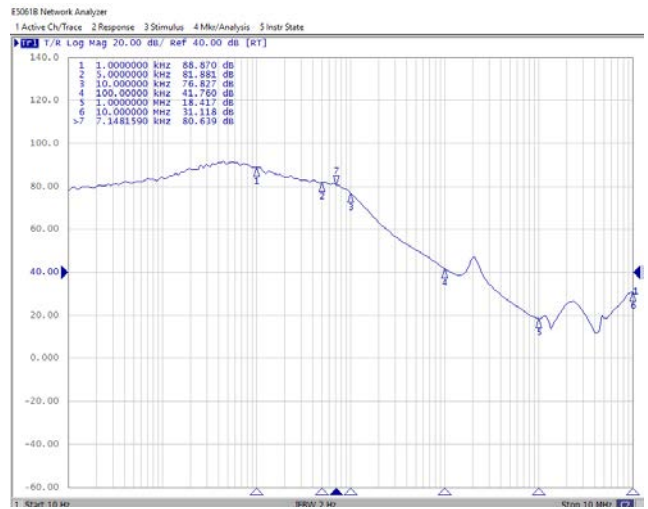

SUL60005-33

I_{Load}=1mA

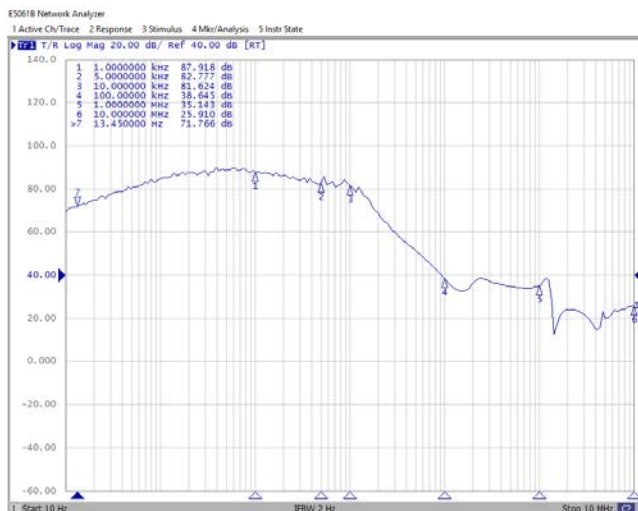

I_{Load}=10mA

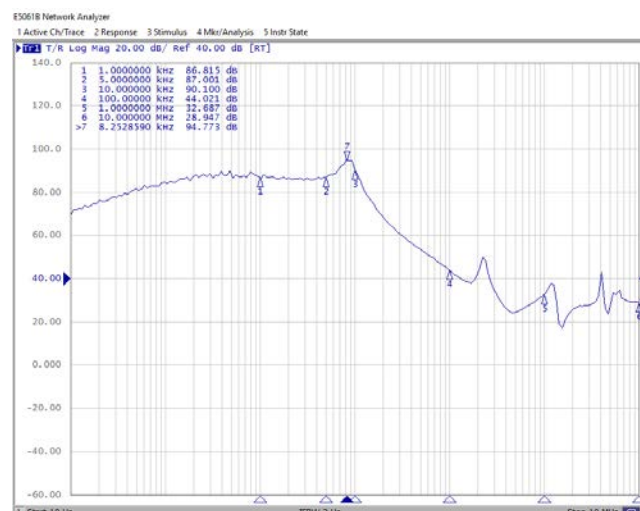

I_{Load}=30mA

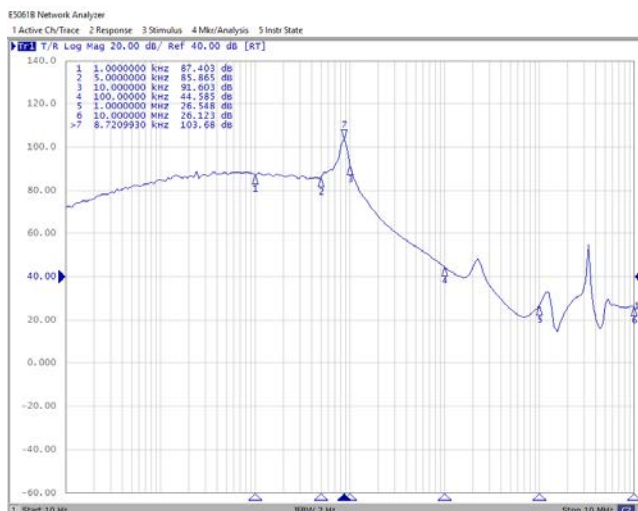

I_{Load}=150mA



Load Transient Response ($V_{IN}=V_{OUT}+1V$, $C_{IN} = C_{OUT} = 1.0 \mu F$, $t_r = t_f = 1 \mu s$, $T_a = 25^\circ C$)

SUL60005-09

1mA -> 250mA

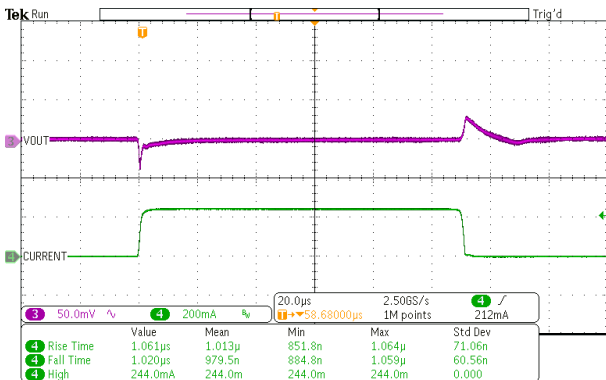

1mA -> 500mA

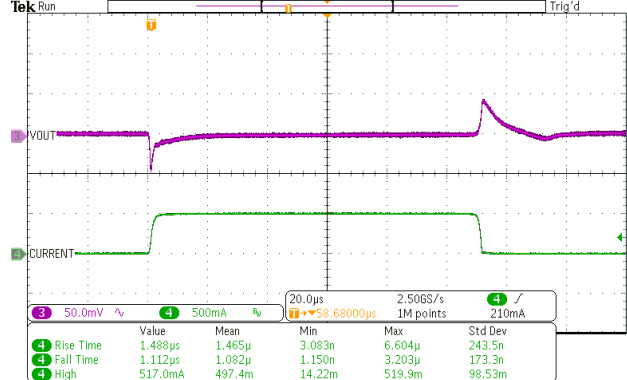

SUL60005-12

1mA -> 250mA

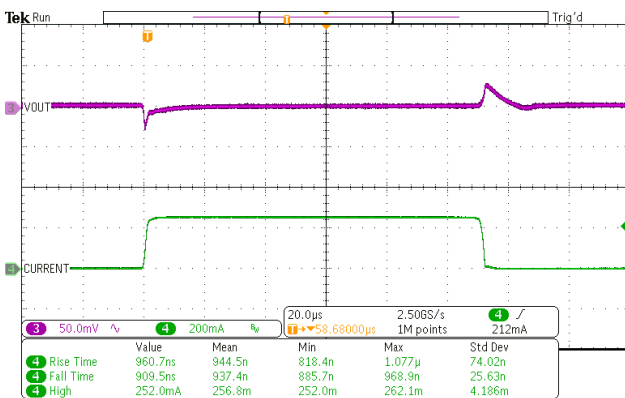

1mA -> 500mA

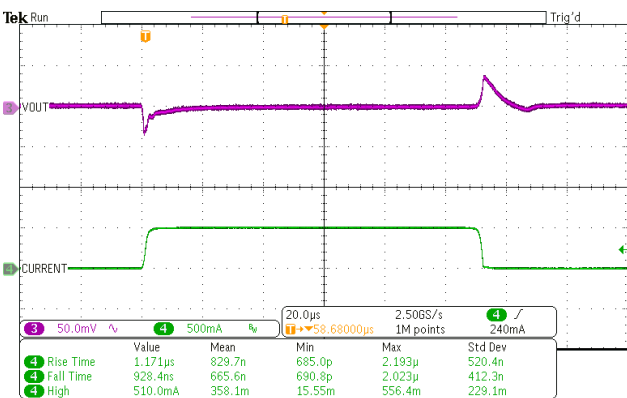

SUL60005-18

1mA -> 250mA

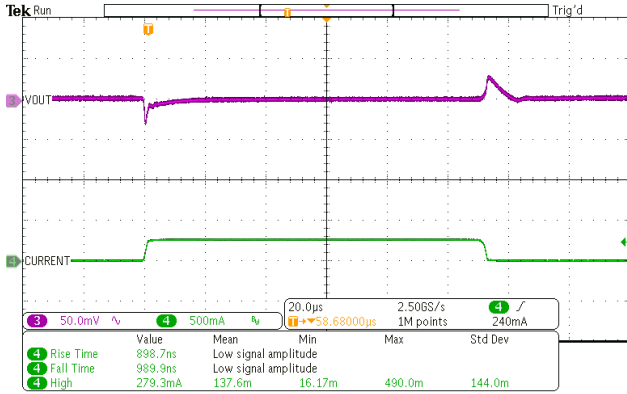

1mA -> 500mA

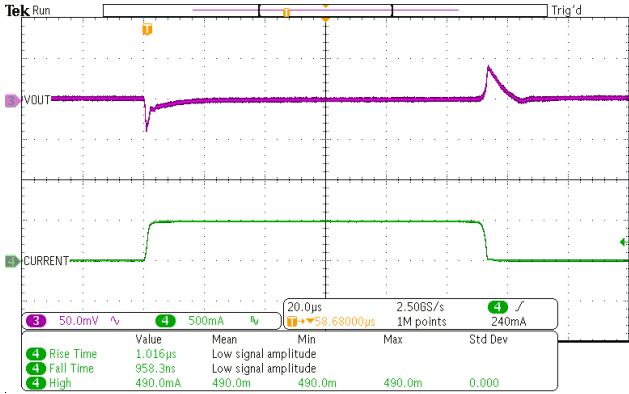

SUL60005-25

1mA -> 250mA

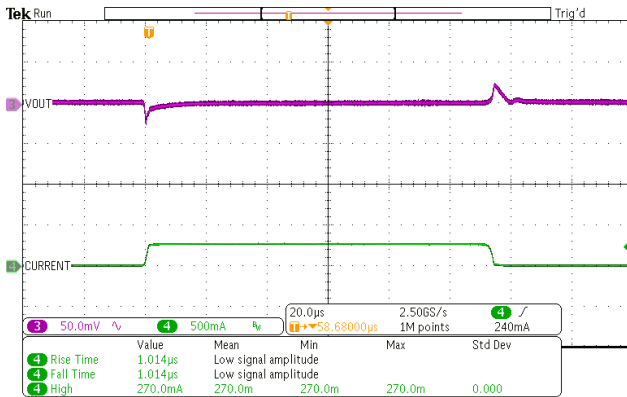

1mA -> 500mA

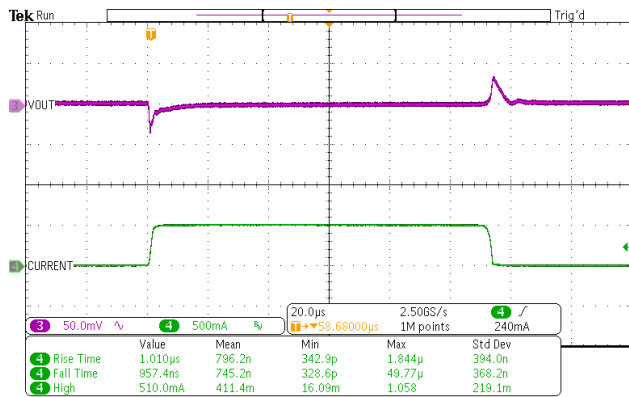

SUL60005-33

1mA -> 250mA

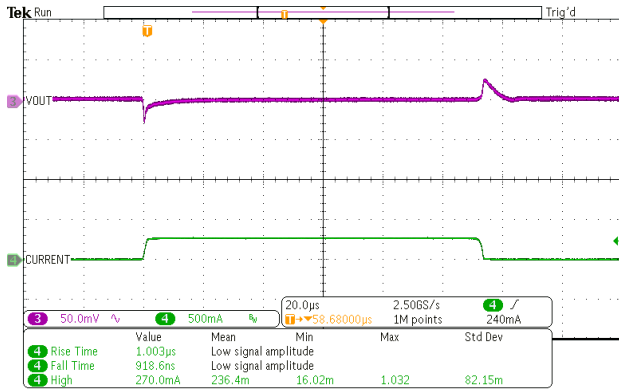

1mA -> 500mA

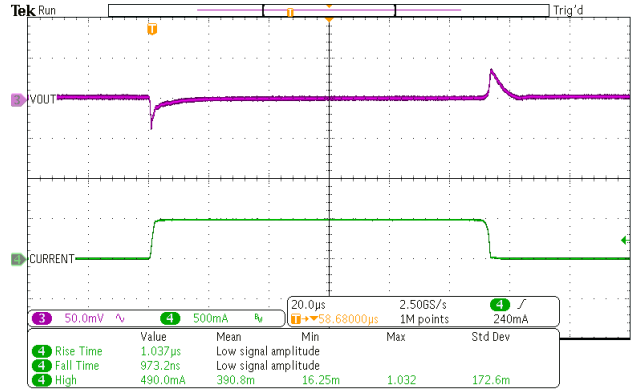

SUL60005-43

1mA -> 250mA

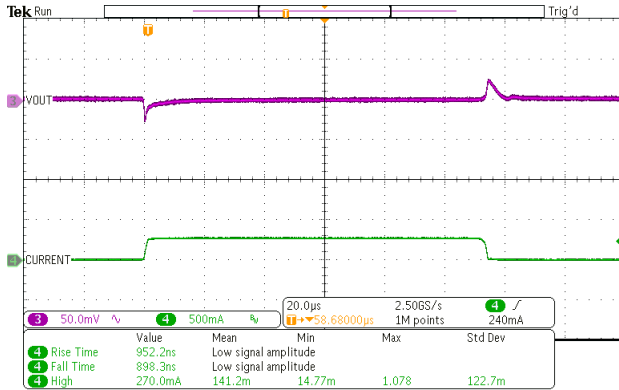

1mA -> 500mA

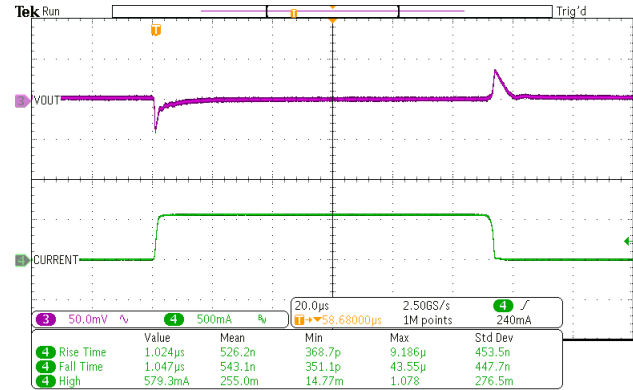

Turn-on waveform by V_{IN} & CE @ light load ($V_{IN} = CE = 0\text{ V}$ to $V_{OUT}+1\text{V}$, $C_{IN} = C_{OUT} = 1.0\ \mu\text{F}$, $T_a = 25^\circ\text{C}$, $I_{OUT} = 1\text{ mA}$)

SUL60005-09

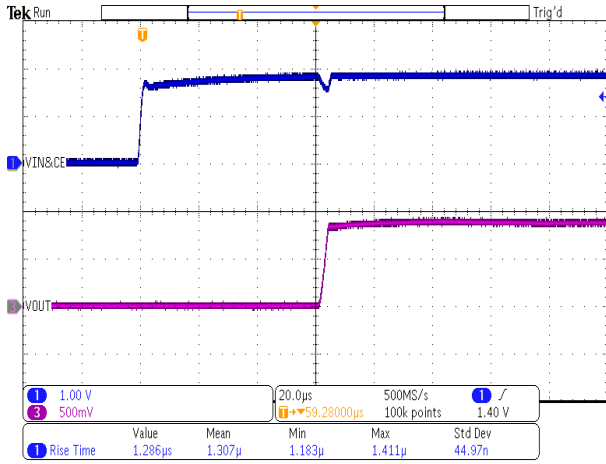

SUL60005-12

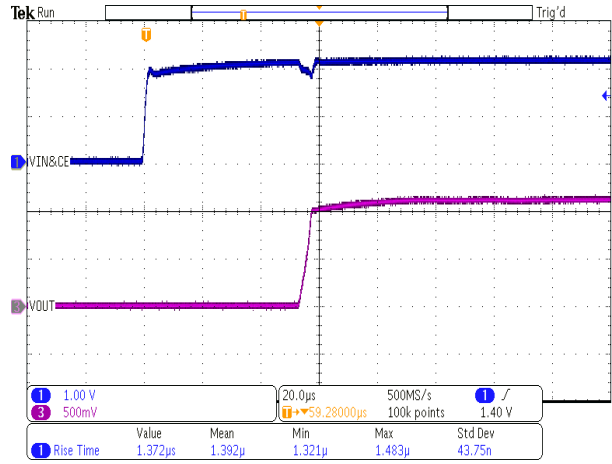

SUL60005-18

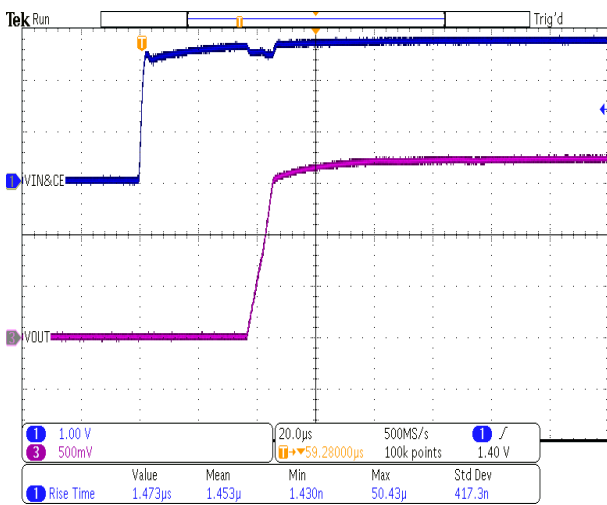

SUL60005-25

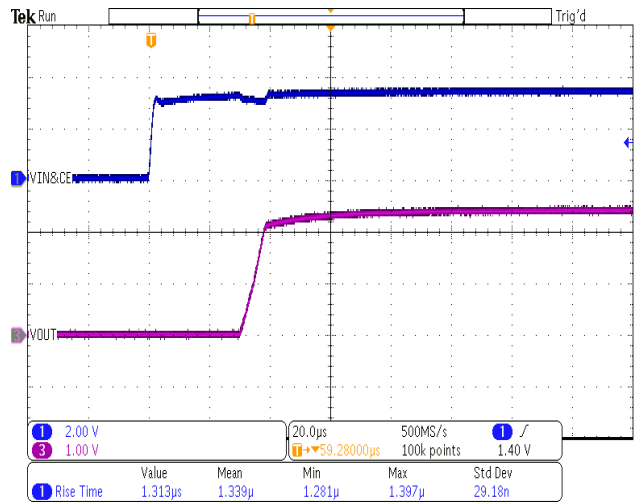

SUL60005-33

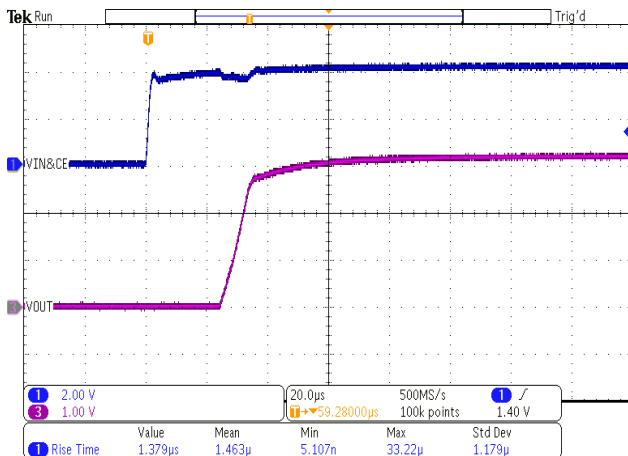

Turn-on waveform by V_{IN} & CE @ full load ($V_{IN} = CE = 0\text{ V}$ to $V_{OUT}+1\text{V}$, $C_{IN} = C_{OUT} = 1.0\ \mu\text{F}$, $T_a = 25^\circ\text{C}$, $I_{OUT}=0.5\text{A}$)

SUL60005-33

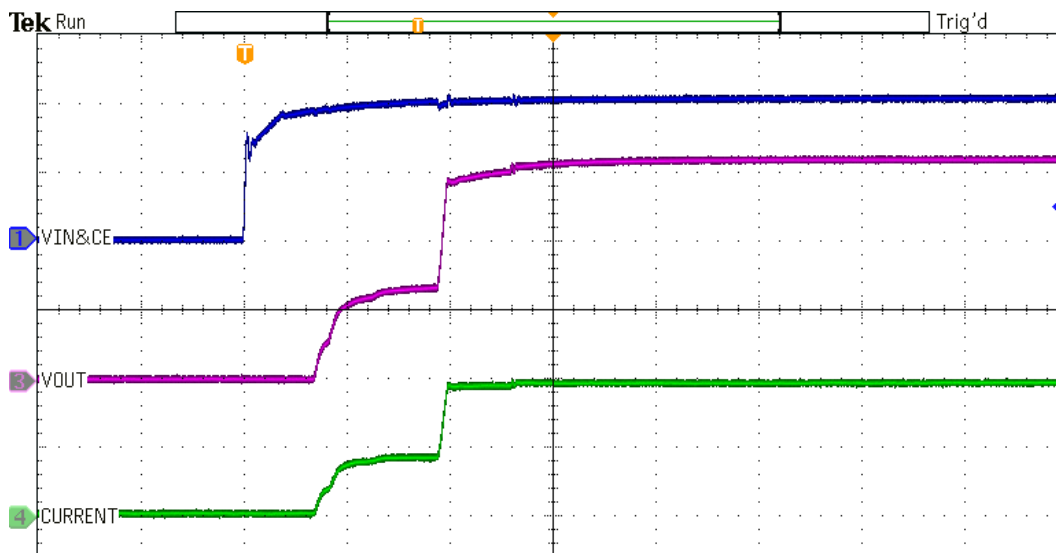

Turn-on by CE pin & Inrush current @ no load ($V_{IN} = V_{OUT}+1\text{V}$, $CE = 0\text{V}$ to 1V , $C_{IN} = C_{OUT} = 1.0\ \mu\text{F}$, $T_a = 25^\circ\text{C}$, $I_{OUT}=0\ \text{mA}$)

SUL60005-33

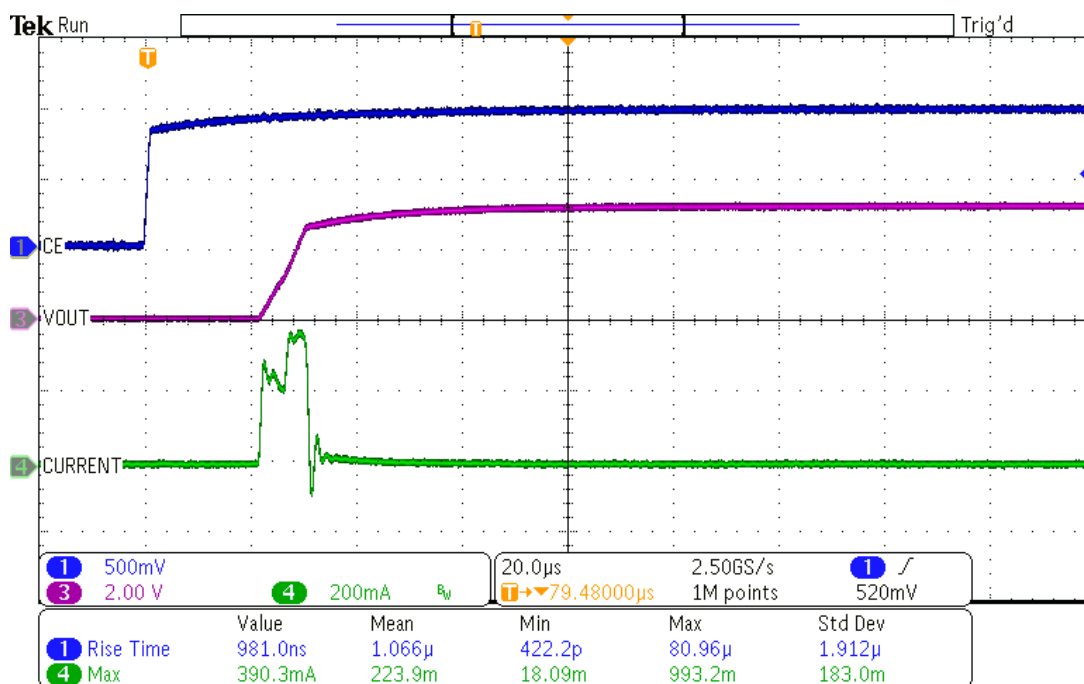

Turn-on by CE pin @ full load ($V_{IN} = V_{OUT} + 1V$, $CE = 0V$ to $1V$, $C_{IN} = C_{OUT} = 1.0 \mu F$, $T_a = 25^\circ C$, $I_{OUT} = 0.5A$)

SUL60005-33

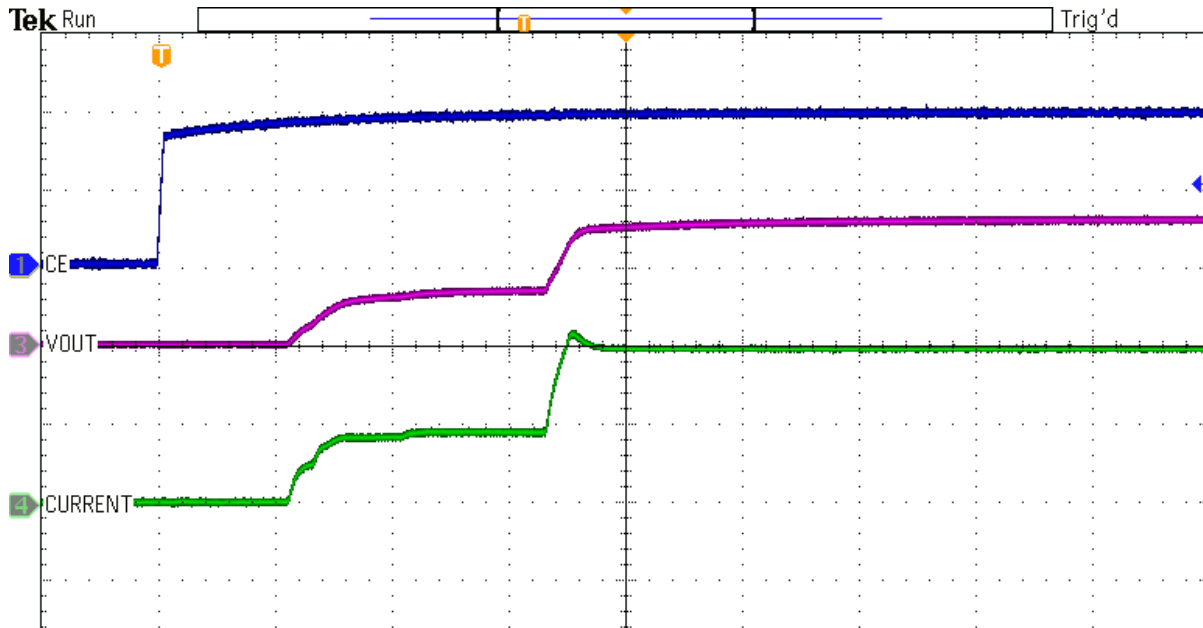

SOT-23-5 Package Information

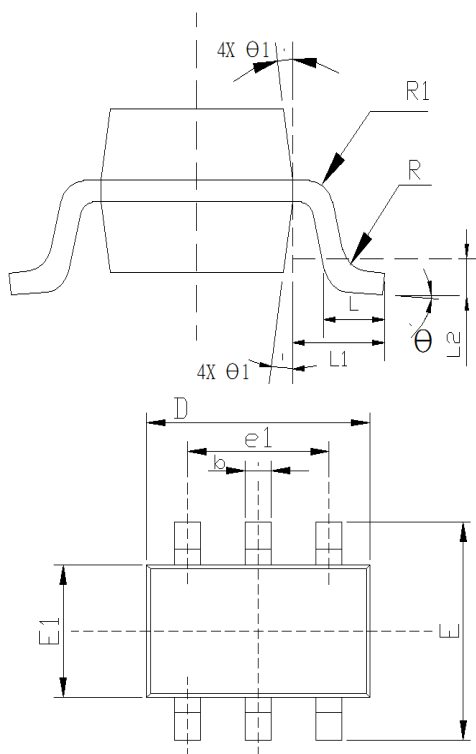
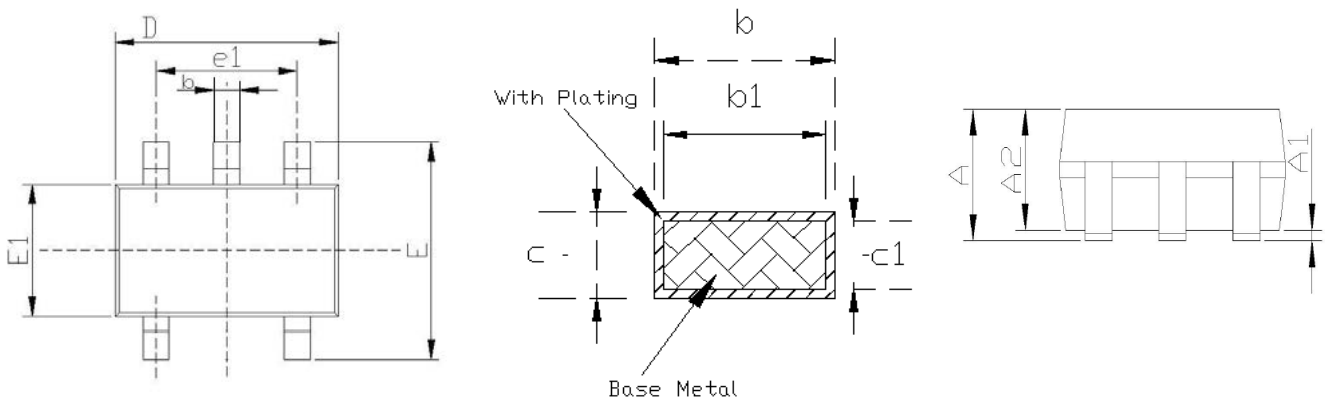

Common Dimensions (Units of Measure=Millimeter)			
SYMBOL	MINIMUM	NOMINAL	MAXIMUM
A	-	-	1.35
A1	0	-	0.15
A2	1.00	1.10	1.20
b	0.35	-	0.45
b1	0.32	-	0.38
c	0.14	-	0.20
c1	0.14	0.15	0.16
D	2.82	2.92	3.02
E	2.60	2.80	3.00
E1	1.526	1.626	1.726
e	0.90	0.95	1.00
e1	1.80	1.90	2.00
L	0.35	0.45	0.60
L1	0.6 REF		
L2	0.25 REF		
R	0.10	-	-
R1	0.10	-	0.25
θ	0°	4°	8°
θ 1	5°	10°	15°

NOTES:

1. All dimensions refer to standard.
2. Dimensions D does not include mold FLASH.
3. Dimensions E1 does not include mold FLASH.
4. FLASH or protrusion shall not exceed 0.25mm per side.

X-ON Electronics

Largest Supplier of Electrical and Electronic Components

Click to view similar products for [Linear Voltage Regulators](#) category:

Click to view products by [Suntek](#) manufacturer:

Other Similar products are found below :

[LV5684PVD-XH](#) [MCDTSA6-2R](#) [L7815ACV-DG](#) [714954EB](#) [ZMR500QFTA](#) [BA033LBSG2-TR](#) [LV5680P-E](#) [L79M05T-E](#) [L78LR05D-MA-E](#) [NCV317MBTG](#) [NTE7227](#) [MP2018GZD-33-P](#) [MP2018GZD-5-P](#) [LV5680NPVC-XH](#) [LT1054CN8](#) [ZTS6538SE](#) [UA78L09CLP](#) [UA78L09CLPR](#) [CAT6221-PPTD-GT3](#) [MC78M09CDTRK](#) [NCV51190MNTAG](#) [78M05](#) [HT7150-1](#) [UM1540DB-18](#) [XC6234H281VR-G](#) [WL2834CA-6/TR](#) [TPL730F33-5TR](#) [TLS850F1TA](#) [V50](#) [TPS549B22RVFR](#) [UM1540DB-33](#) [WL9200P3-50B](#) [WL9100P3-33B](#) [WL9005D4-33](#) [XC6219B152MR](#) [WL2855K33-3/TR](#) [PJ54BM33SE](#) [PJ9500M25SA](#) [MD7218E33PC1](#) [H7533-2PR](#) [SK7812AU](#) [SD1A30](#) [78L33](#) [TP78L33T3](#) [L78L33ACUTR](#) [SK6513ST3A-50](#) [SK6054D4-09](#) [SK6054D4-18](#) [SK6054D4-11](#) [SK6054D4-10](#) [LM79L12F](#)