

# SUL6001

## Low Noise High PSRR 1 Ch 500mA/1A Ultra Low Dropout LDO

### FUNCTIONAL DESCRIPTION

The SUL6001 series is a CMOS-based positive low-dropout linear regulator (LDO) featuring 500 mA/ 1.0A that provides high PSRR, high output voltage accuracy, low-noise and low supply current

It consists of a voltage reference, an error amplifier, a resistor-ladder for output voltage setting. It also has under-voltage lockout (UVLO), over current/short circuit protection circuit and over temperature shutdown circuit.

The SUL6001 typically has 95mV dropout voltage (DFN1216-8, I<sub>out</sub>=1A, V<sub>out</sub>=3.3V) and 156mA dropout voltage (DFN1216-8, I<sub>out</sub>=1A, V<sub>out</sub>=1.8V) and chip enable function (EN) for long battery life.

Excellent ripple rejection, load transient and line transient response make it ideal for the power sources of mobile communication devices or camera modules in low light condition. It can also turn on under full load condition, making it suitable for harsh system environment.

The SUL6001 series LDOs have option for output current limit between 1.0A or 500mA by alternating the LCON pin between “H” or “L” for DFN1216-8 package version.

### MAIN FEATURES

- Supply Current (no load): 85μA (typ.)
- Supply Current (Standby): 0.1μA (typ.)
- Dropout Voltage: 95mV (DFN1216-8, I<sub>out</sub>=1A, V<sub>out</sub>=3.3V, typ.)
- High-PSRR: 85dB @1kHz
- Output Noise: 10μV<sub>rms</sub> (10-100KHz, 0.85V output voltage settings, typ.)
- Line Regulation: 0.01%/V
- Fixed Mode Voltage Range: 0.85V to 4.3V with 0.05V step.
- Adjustable Mode Voltage Range: 0.85V to 4.6V.
- Built-in Short Current Protection Limit: 120mA (LCON='H', 1.0A, typ.)
- Built-in Peak Current Protection Limit: 1.7A (LCON='H', 1.0A, typ.)
- Over Temperature Protection and Auto Recover
- Built-in Soft-Start and Inrush Current Limit
- Fast Auto Discharge Function for Power Down

### APPLICATIONS

- Portable Device , Tablets and Smartphone
- Cameras, VCRs and Car Dash Cameras
- Low Light & Low Noise Cam Application
- Communications and Infrastructure
- AR or VR Application

## BLOCK DIAGRAMS

### DFN1216-8 (8 PIN)

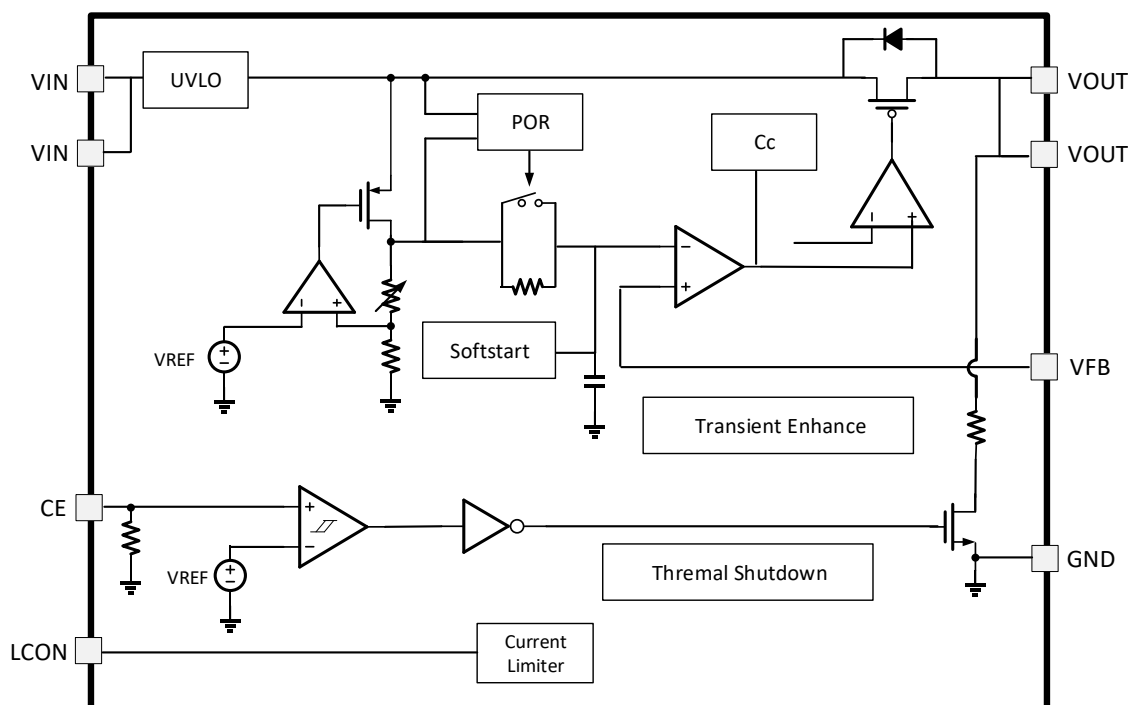

### SOT-89-3 (3 PIN)

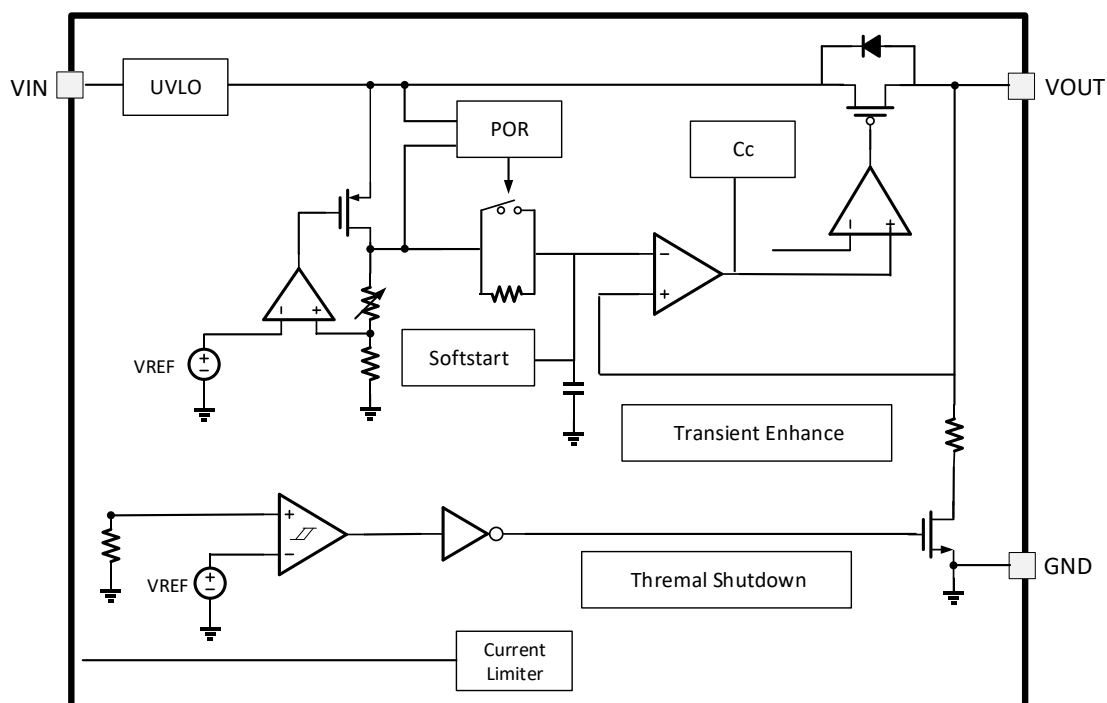

### SOT-89-5 (5 PIN)

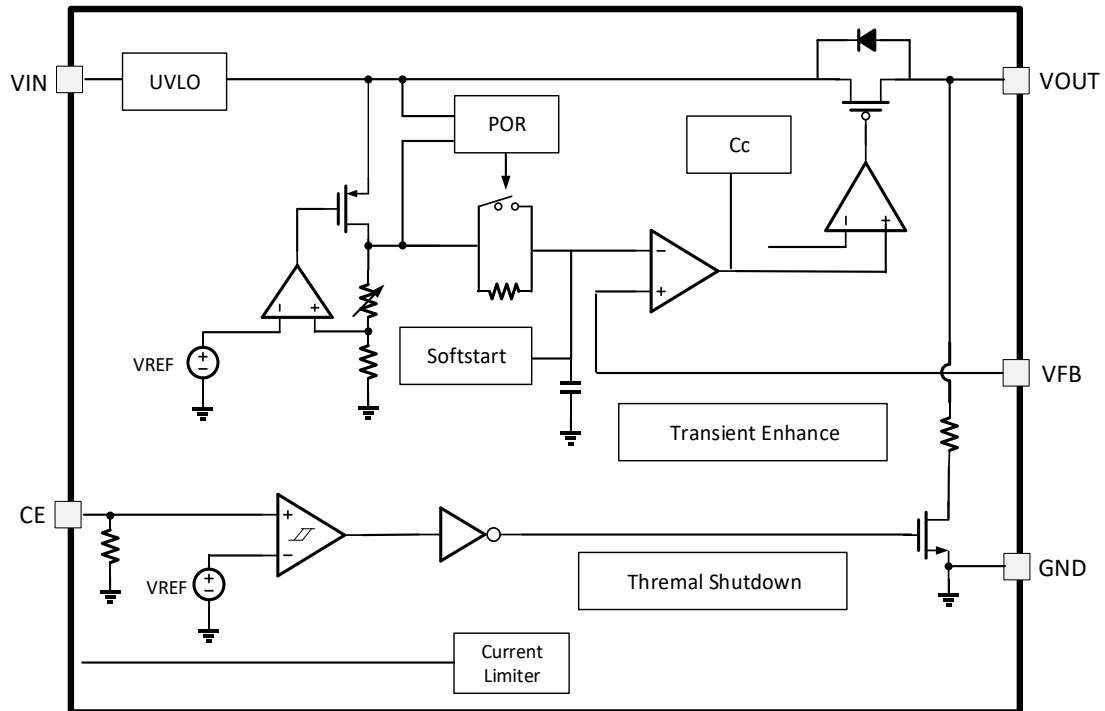

### SOT-23-5 Fixed Mode (5 PIN)

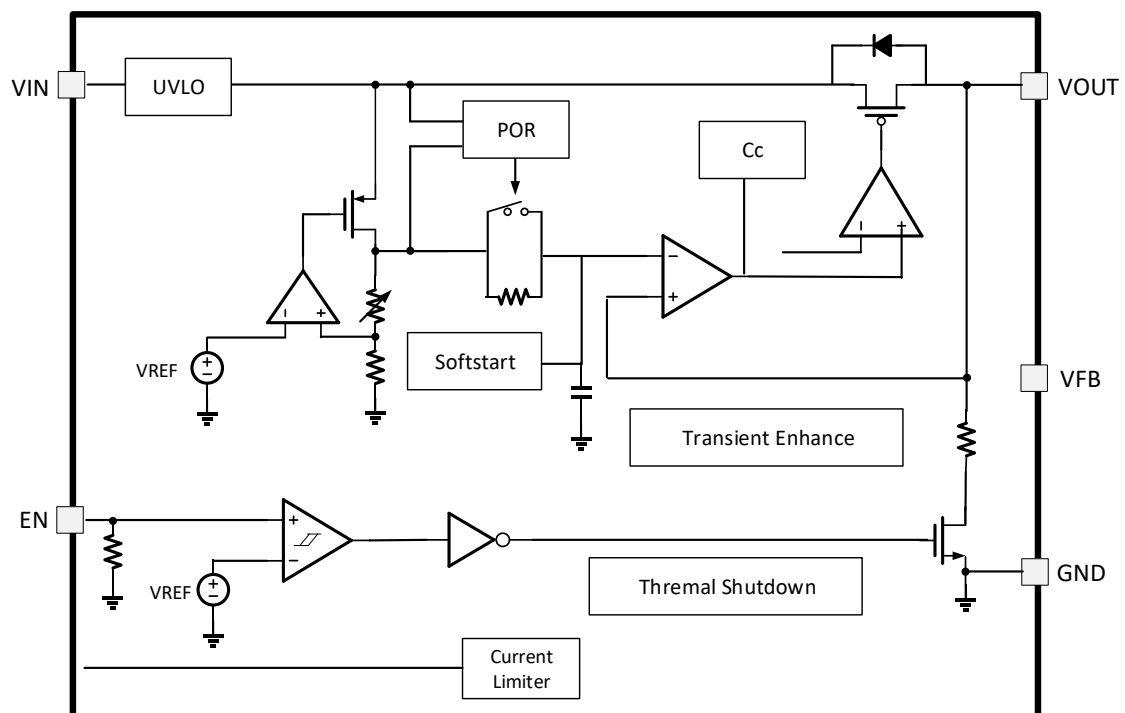

## SOT-23-5 ADJ Mode (5 PIN)

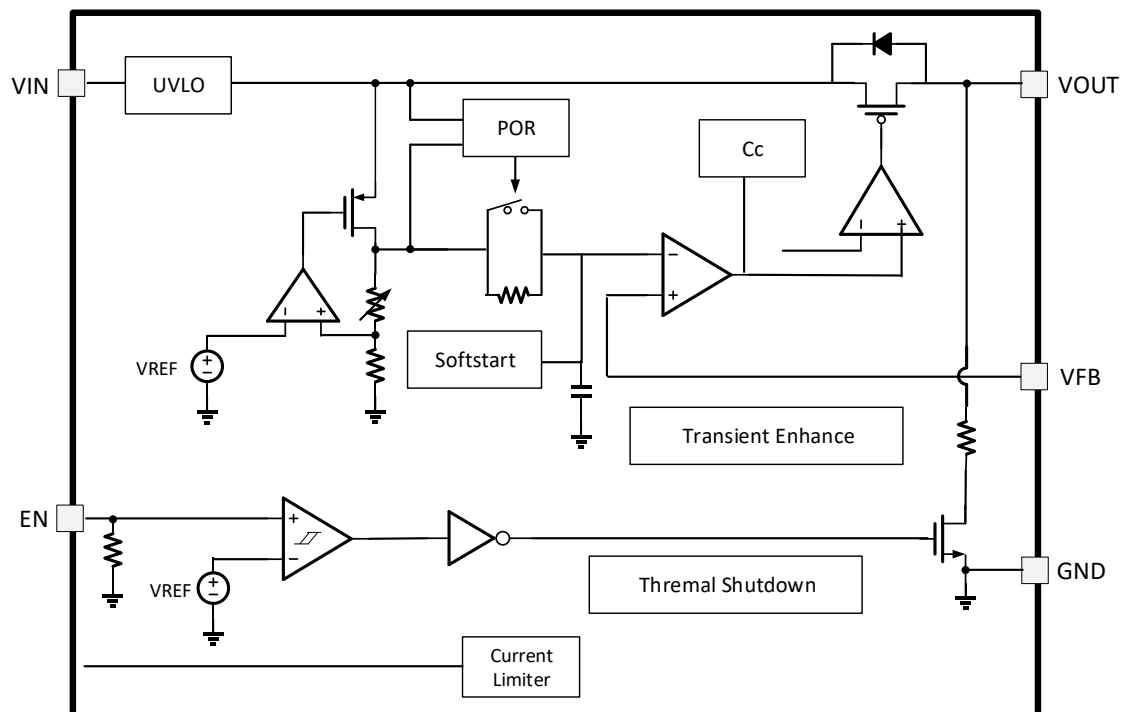

It is not recommended to use the 1A version of the SOT-23-5 package.

### Ordering Information

Part Number	Package	Tape/Reel
SUL6001S5-XX	SOT23-5	3000
SUL6001T5-XX	SOT89-5	1000
SUL6001D6-XX	DFN2x2-6	4000
SUL6001DRB	DFN3x3-8	5000
SUL6001D8-XX	DFN1216-8	3000

For example, 28 means product outputs 2.8V, ADJ means adjustable.  
SUL6001 devices are Pb-free and RoHS compliant.

## PACKAGE INFORMATION & PIN DESCRIPTION

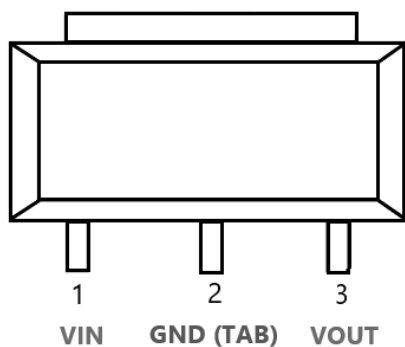

**SOT-89-3-AFT  
Pin Configuration**

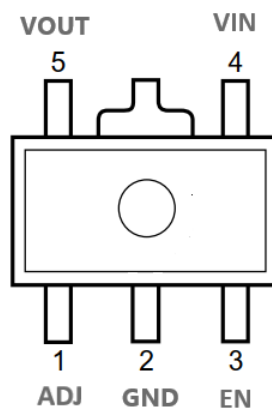

**SOT-89-5 Pin Configuration**

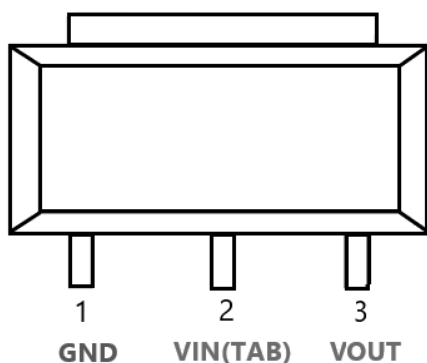

**SOT-89-3-BFT  
Pin Configuration**

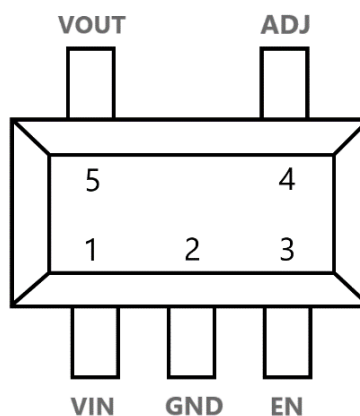

**SOT-23-5 Pin Configuration (ADJ Mode)**

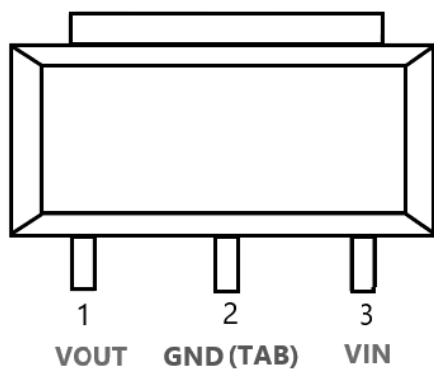

**SOT-89-3-CFT  
Pin Configuration**

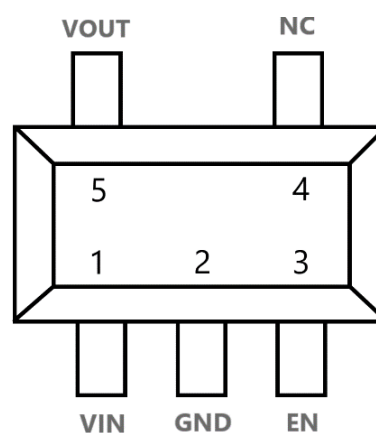

**SOT-23-5 Pin Configuration (Fixed Mode)**

**Top View**

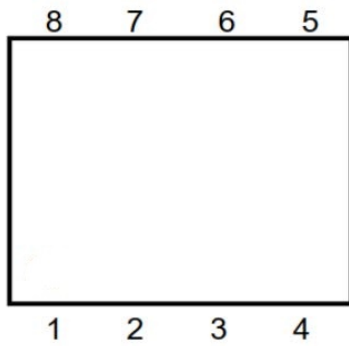

**Bottom View**

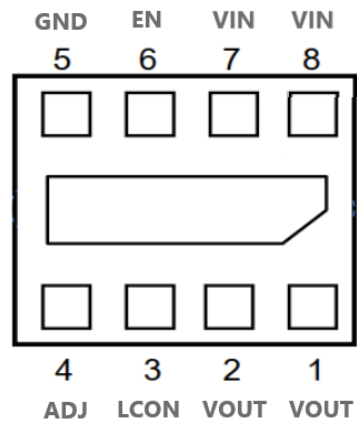

**DFN1216-8 Pin Configuration**

**Top View**

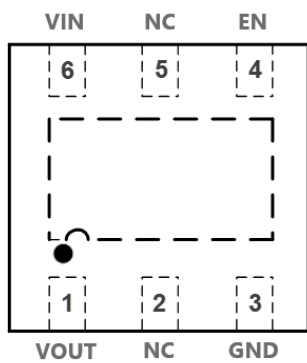

**DFN2020-6 Fixed Pin Configuration**

**Top View**

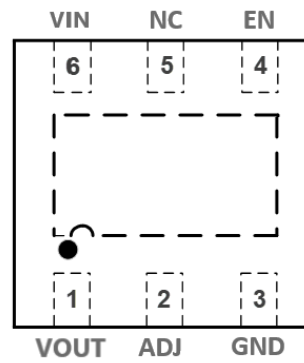

**DFN2020-6 ADJ Pin Configuration**

**Top View**

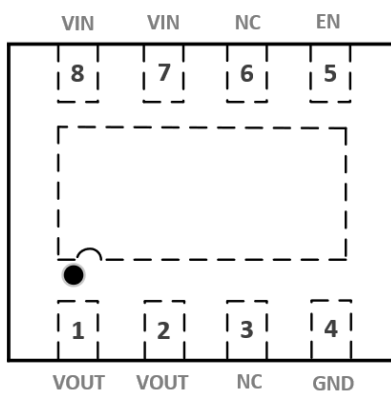

**DFN 3030-8 Fixed**

**Top View**

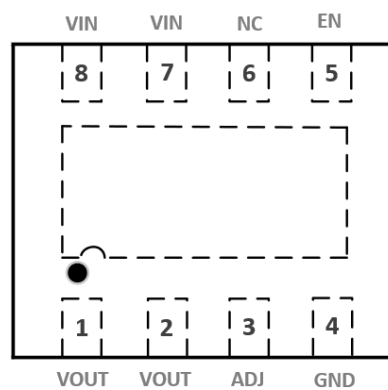

**DFN 3030-8 ADJ**

Pin Name	Pin Function	PIN No				
		DFN1216-8	DFN3030-8		DFN2020-6	
			Fixed	ADJ	Fixed	ADJ
VIN	Input of Supply Voltage.	7, 8	7, 8	7, 8	6	6
VOUT	LDO Output Voltage pin.	1, 2	1, 2	1, 2	1	1
GND	Ground.	5	4	4	3	3
EN	Enable pin.	6	5	5	4	4
NC	No internal connection.	NA	3, 6	6	2, 5	5
ADJ	ADJ pin.	4	NA	3	NA	2
LCON	Output Current Limit Alternate Pin.	3	NA	NA	NA	NA

Pin Name	Pin Function	PIN No					
		SOT-23-5		SOT-89-3			SOT-89-5
		Fixed	ADJ	A	B	C	ADJ
VIN	Input of Supply Voltage.	1	1	1	2	3	4
VOUT	LDO Output Voltage pin.	5	5	3	3	1	5
GND	Ground.	2	2	2	1	2	2
EN	Enable pin.	3	3	NA	NA	NA	3
NC	No internal connection.	4	NA	NA	NA	NA	NA
ADJ	ADJ pin.	NA	4	NA	NA	NA	1

**\*Note: Connect exposed pad (heat sink on the back) to GND.**

## TYPICAL APPLICATION CIRCUIT

### A. Fixed mode example

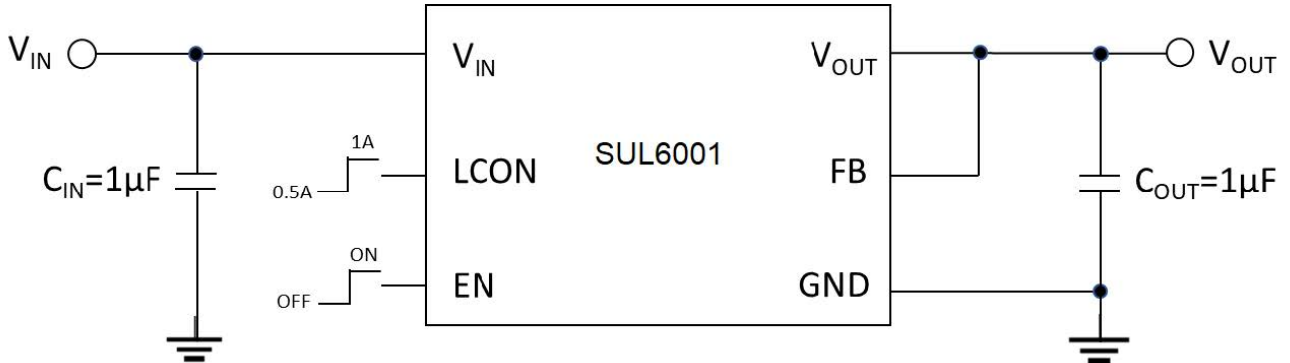

\* Recommended Ceramic Capacitors for  $V_{IN}$  and  $V_{OUT}$ : 1µF

### B. Adjustable (ADJ) mode example

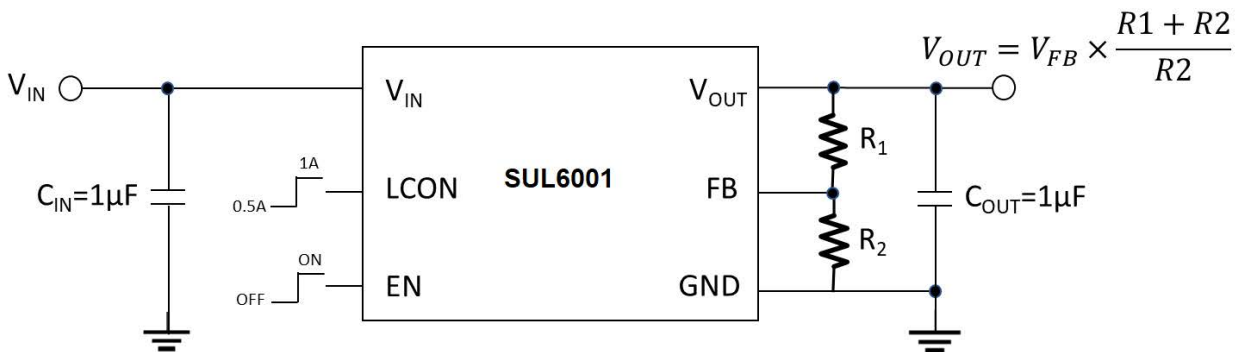

The adjustable-version device requires external feedback divider resistors to set the output voltage.

$V_{OUT}$  is set using the feedback divider resistors,  $R_1$  and  $R_2$ , according to the following equation:

$$V_{OUT} = V_{FB} \times (1 + R_1 / R_2)$$

For this device,  $V_{FB} = 0.85$  V.

To ignore the FB pin current error term in the  $V_{OUT}$  equation, set the feedback divider current to 100x the FB pin current listed in the *Electrical Characteristics* table. This setting provides the maximum feedback divider series resistance, as shown in the following equation:

$$R_1 + R_2 \leq V_{OUT} / (I_{FB} \times 100)$$

For this device,  $I_{FB} = 10$  nA.



## ABSOLUTE MAXIMUM RATINGS

Symbol	Item	Rating		Unit
V <sub>IN</sub>	Input Voltage	6.0		V
V <sub>CE</sub>	Input Voltage (CE Pin)	-0.3 to 6.0		V
V <sub>LCON</sub>	Input Voltage (LCON Pin)	-0.3 to 6.0		V
V <sub>OUT</sub>	Output Voltage	-0.3 to 6.0		V
P <sub>D</sub>	Power Dissipation (Standard Land Pattern)	DFN1216-8	1400	mW
		DFN3*3-8	1950	mW
T <sub>OP</sub>	Junction Temperature Range	-40 to 125		°C
T <sub>STG</sub>	Storage Temperature Range	-55 to 125		°C

## RECOMMENDED OPERATING CONDITIONS

Symbol	Item	Rating	Unit
V <sub>IN</sub>	Input Voltage	1.32 to 5.5	V
V <sub>OUT</sub>	Output Voltage	0.85 to 4.3	V
T <sub>a</sub>	Operating Temperature Range	-40 to 85	°C
C <sub>IN</sub> /C <sub>OUT</sub>	Input/Output Capacitance	1/1	uF

## ELECTROSTATIC DISCHARGE

Symbol	Parameter	Value	Unit
ESD	Human Body Mode	± 4	kV
	Machine Mode	± 250	V
	Charge Device Mode	± 1000	V

## THERMAL DATA

Symbol	Parameter	Value		Unit
$\theta_{JA}$	Thermal resistance junction-ambient	DFN3*3	53	°C/W
		DFN1216	80	
		SOT23-5	260	

## ELECTRICAL CHARACTERISTICS

$V_{IN} = V_{OUT} + 1.0\text{ V}$ ,  $I_{OUT} = 1\text{ mA}$ ,  $C_{IN} = C_{OUT} = 1.0\text{ }\mu\text{F}$ , typical values are at  $T_J = 25\text{ }^\circ\text{C}$ ; unless otherwise noted.

Symbol	Parameter	Conditions	Min.	Typ.	Max.	Unit	
$V_{IN}$	Operating input voltage		1.32		5.50	V	
$V_{OUT}$	$V_{OUT}$ accuracy	$V_{OUT} + 0.5\text{ V} \leq V_{IN} \leq 5.5\text{ V}$	$V_{OUT} \geq 1.75\text{ V}$	-1.0	+1.0	%	
			$V_{OUT} < 1.75\text{ V}$	-20	+20	mV	
$\Delta V_{OUT}$	Static line regulation			0.01		%/V	
$\Delta V_{OUT}$	Static load regulation	$I_{OUT} = 10\text{ mA to }500\text{ mA}$		1	20	mV	
		$I_{OUT} = 10\text{ mA to }1000\text{ mA}$			40		
$V_{DROP}$	Dropout voltage	$I_{OUT} = 1\text{ A}$	$V_{OUT}=1.2\text{ V}$		245	340	mV
			$V_{OUT}=1.8\text{ V}$		140	235	
			$V_{OUT}=2.5\text{ V}$		105	175	
			$V_{OUT}=3.3\text{ V}$		85	150	
			$V_{OUT}=4.3\text{ V}$		60	130	
		$I_{OUT} = 500\text{ mA}$ For SOT-23-5	$V_{OUT}=1.2\text{ V}$		150	210	
			$V_{OUT}=1.8\text{ V}$		80	135	
			$V_{OUT}=2.5\text{ V}$		60	100	
			$V_{OUT}=3.3\text{ V}$		50	105	
			$V_{OUT}=4.3\text{ V}$		40	85	
$I_Q$	Quiescent current	$I_{OUT} = 0\text{ mA}$		85	140	$\mu\text{A}$	
$I_{Standby}$	Standby current	$V_{IN}$ input current in OFF MODE: $V_{EN} = \text{GND}$		0.1	3	$\mu\text{A}$	
$I_{LIM}$	Output current limit	$I_{OUT} = 500\text{ mA}$	0.6	0.78		A	
		$I_{OUT} = 1\text{ A}$		1.7			
$I_{SC}$	Short-circuit current	$V_{OUT} = 0\text{ V}$	$I_{OUT} = 500\text{ mA}$			186	mA
			$I_{OUT} = 1\text{ A}$				
$I_{FB}$	Feedback pin current			0.01	0.1	$\mu\text{A}$	

## ELECTRICAL CHARACTERISTICS (continued)

Symbol	Parameter	Conditions	Min.	Typ.	Max.	Unit
e <sub>N</sub>	Output noise voltage			10		μVrms
PSRR	Power Supply Rejection Ratio			85		dB
T <sub>TSD</sub>	Thermal shutdown	Shutdown, temperature increasing		165		°C
		Reset, temperature decreasing		135		°C
CE	Enable input logic low	V <sub>IN</sub> = 1.32 V to 5.5 V			0.4	V
	Enable input logic high	V <sub>IN</sub> = 1.32 V to 5.5 V	1			
LCON	LCON input logic low	V <sub>IN</sub> = 1.32 V to 5.5 V			0.4	V
	LCON input logic high	V <sub>IN</sub> = 1.32 V to 5.5 V	1			

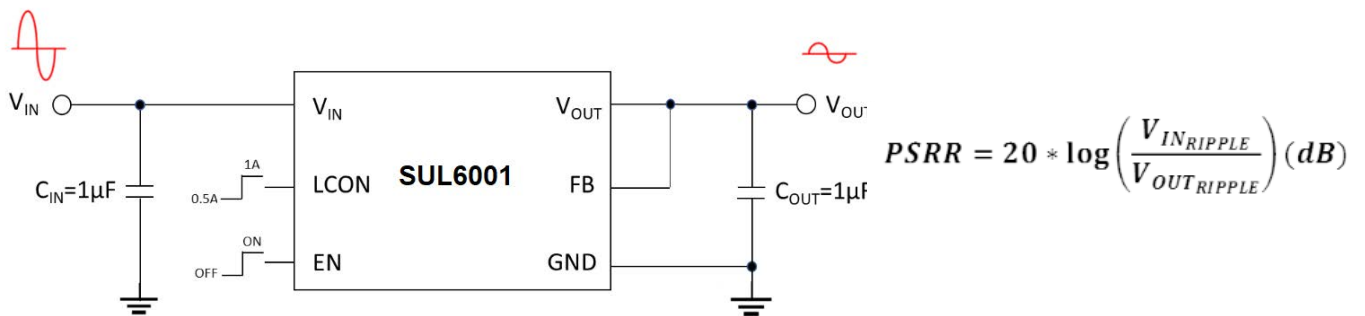

\*This is SUL6001D8-33 measurement data. Other PSRR information please contact SUNTEK.

## Load Regulation (Dynamic)

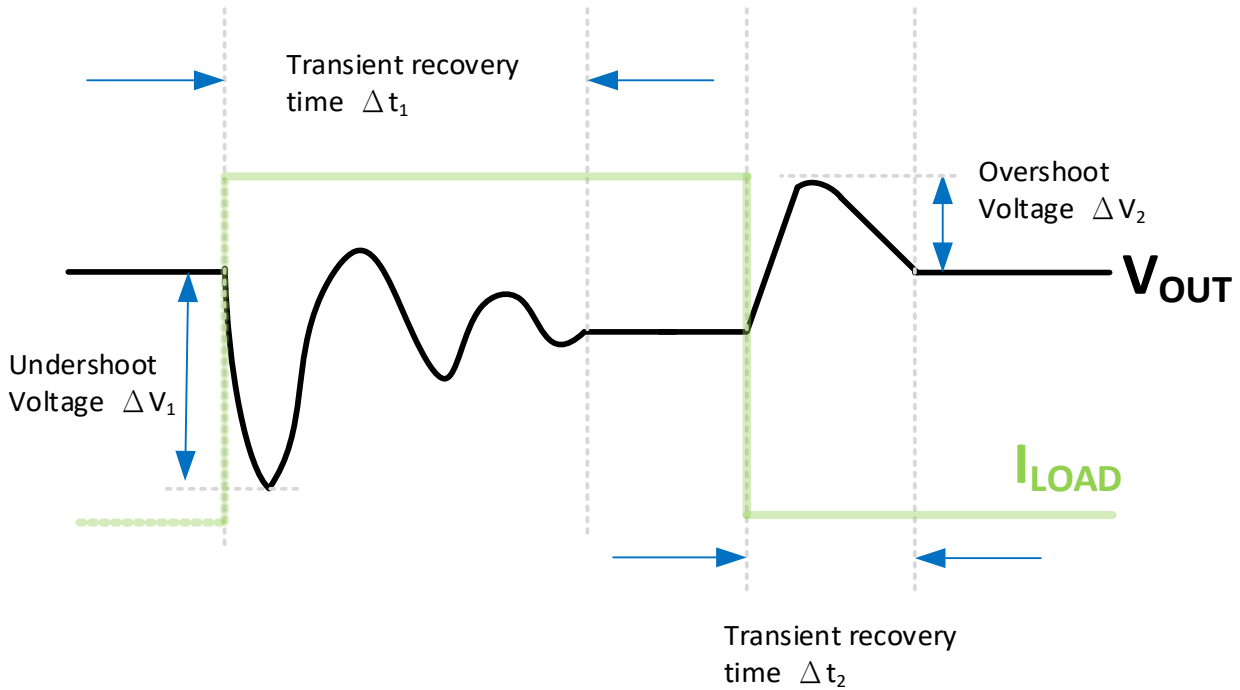

Symbol	Parameter	Condition	Min.	Typ.	Max.	Unit
$\Delta V_1$	Undershoot Voltage	$I_{LOAD}=1mA\sim 250mA$		30		mV
		$I_{LOAD}=1mA\sim 500mA$		40		
		$I_{LOAD}=1mA\sim 1A$		62		
		$I_{LOAD}=0mA\sim 300mA$		50		
		$I_{LOAD}=0mA\sim 1A$		90		
$\Delta V_2$	Overshoot Voltage	$I_{LOAD}=1mA\sim 250mA$		28		mV
		$I_{LOAD}=1mA\sim 500mA$		40		
		$I_{LOAD}=1mA\sim 1A$		60		
		$I_{LOAD}=0mA\sim 300mA$		35		
		$I_{LOAD}=0mA\sim 1A$		65		

Symbol	Parameter	Condition	Min.	Typ.	Max.	Unit
$\Delta t_1$	Transient recovery time	$I_{LOAD}=1mA\sim 250mA$		10		$\mu S$
		$I_{LOAD}=1mA\sim 500mA$		16		
		$I_{LOAD}=1mA\sim 1A$		18		
		$I_{LOAD}=0mA\sim 300mA$		60		
		$I_{LOAD}=0mA\sim 1A$		80		
$\Delta t_2$	Transient recovery time	$I_{LOAD}=1mA\sim 250mA$		12		$\mu S$
		$I_{LOAD}=1mA\sim 500mA$		12		
		$I_{LOAD}=1mA\sim 1A$		16		
		$I_{LOAD}=0mA\sim 300mA$		90		
		$I_{LOAD}=0mA\sim 1A$		300		

\*This table is SUL6001D8-33 measurement data. For detail load regulation information about other SUL6001 series LDOs, please contact SUNTEK.

---

## FUNCTION DESCRIPTION

### A. Short-Circuit Protect and Current Limitation

SUL6001 series LDOs can protect internal circuit under short-circuit condition on the output. When the load current increases above 1.55 A, the current limit and current foldback mechanism starts to restrict the  $I_{LIM}$  value. If the load resistance decreases even more then the foldback, circuit starts limiting the current to 0.2 A when  $V_{OUT} = 0$ .

### B. Over Temperature Protection and Auto Recover

In order to prevent over thermal condition from damaging the device, SUL6001 series LDOs have internal thermal limiting functions designed to protect the device. It will rapidly shut off PMOS pass element during over temperature condition.

### C. Current Foldback

The current limiting/ current foldback circuit plays an important role by controlling any excessive output current. Our SUL6001 series LDOs provide a current foldback circuit that can detect accurately when an over-current condition occurs.

### D. Very Fast Transient Response

In addition to the main feedback loop, SUL6001 series LDOs contain a fast-transient loop that allows the LDO to respond faster to large-output transients. SUL6001 series LDOs that contain this loop are better able to minimize the effects of a load transient even the output capacitance is small. The recommended output capacitance value is 1 $\mu$ F. It's small size greatly reduce the cost and save PCB area.

### E. Ultra High PSRR and Extreme Low Noise

SUNTEK's SUL6001 series high-performance LDO regulators feature remarkable power supply rejection ratio characteristics (up to 104 dB at 10 kHz) and extreme-low noise operation (as low as 6.3  $\mu$ VRMS with A-wt) resulting in cleaner and stable output voltages. Our LDO is very suitable for ultra-sensitive loads like camera module and security monitor, especially in low light condition.

---

## **F. Start-Up at Full Load**

SUL6001 series LDOs can start-up at full load, make it very suitable for heavy load start up condition and severe system timing constraint.

## **G. Auto Discharge Function**

SUL6001 series LDOs have an auto discharge function to quickly force the output voltage to zero. When the LDO is disabled, the auto discharge function quickly discharge the output capacitor, thereby reducing the output voltage to nearly zero. This function is very useful for quickly ON/OFF application.

## **H. Low Quiescent Current**

SUL6001 series LDOs consume only 85 $\mu$ A (typical) while operating with no load condition. By reducing the quiescent current, your application can stay in standby/sleep mode much longer than leading low quiescent current LDOs in the market.

## **I. Under Voltage Lock OUT (UVLO)**

SUL6001 has an undervoltage lockout (UVLO) function to make sure that whole circuit does nothing until the power supply voltage is high enough. When power supply voltage is high enough, reference circuit can generate right voltage ; logic function can generate correct control signals. This UVLO function can guarantee robust system performance.

## TYPICAL CHARACTERISTICS

$V_{IN} = V_{SET}^{(1)} + 1.0\text{ V}$ ,  $I_{OUT} = 1\text{ mA}$ ,  $C_{IN} = C_{OUT} = 1.0\text{ }\mu\text{F}$ ,  $L_{CON}='H'$ , typical values are at  $T_J = 25\text{ }^\circ\text{C}$ ; unless otherwise noted.

### Output Voltage vs. Input Voltage ( $C_{IN} = C_{OUT} = 1.0\text{ }\mu\text{F}$ , $T_a = 25\text{ }^\circ\text{C}$ )

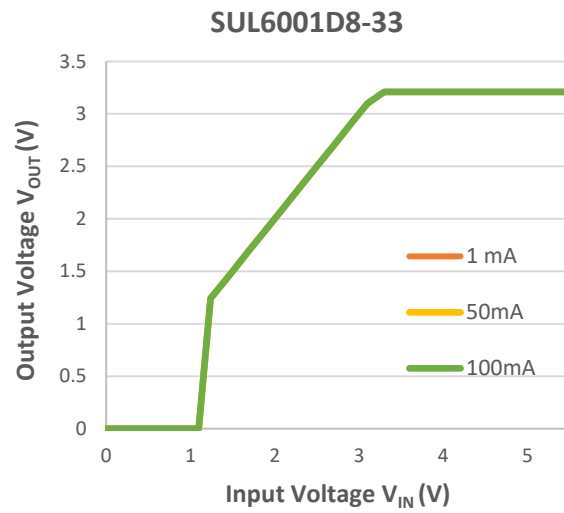
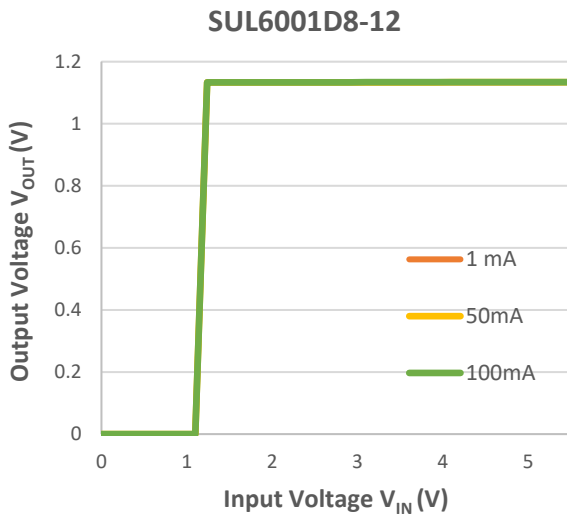

### Supply Current vs. Input Voltage ( $C_{IN} = C_{OUT} = 1.0\text{ }\mu\text{F}$ , $T_a = 25\text{ }^\circ\text{C}$ )

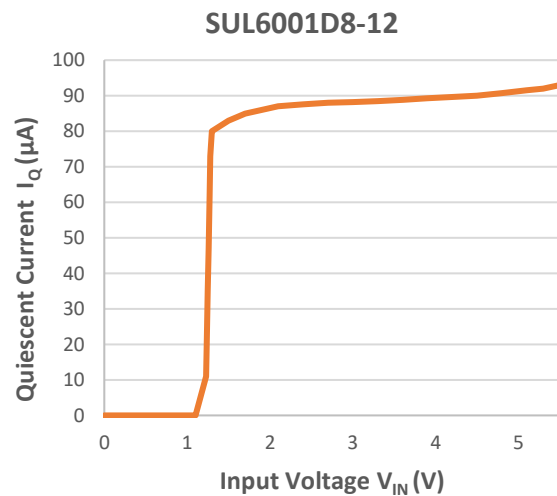
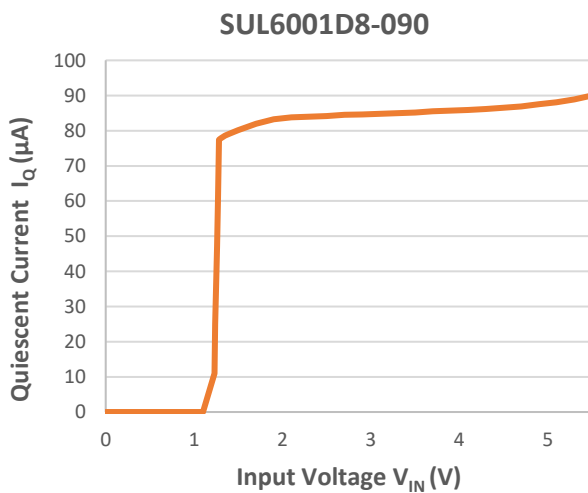



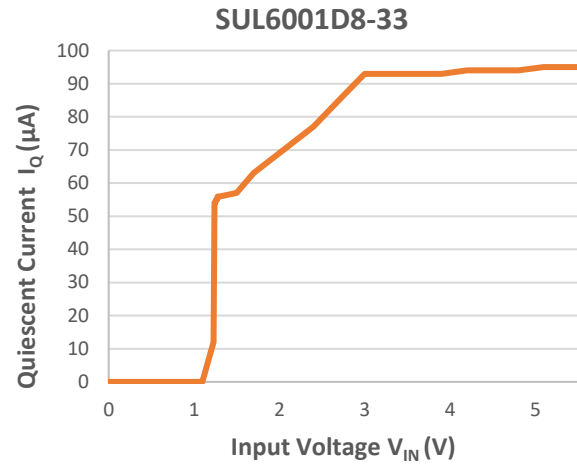
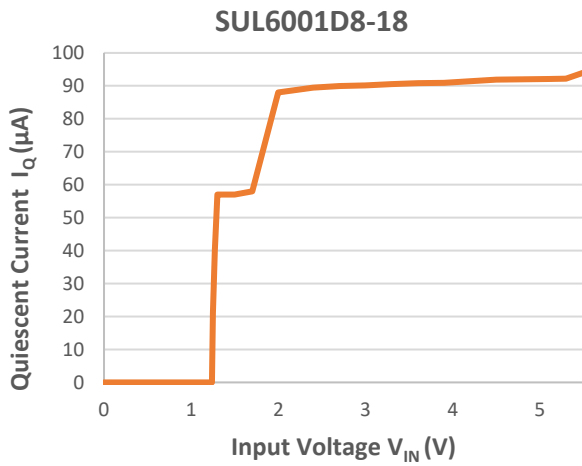

**Supply Current vs. Temperature (CIN = COUT = 1.0 $\mu$ F, IOU= 0 mA )**

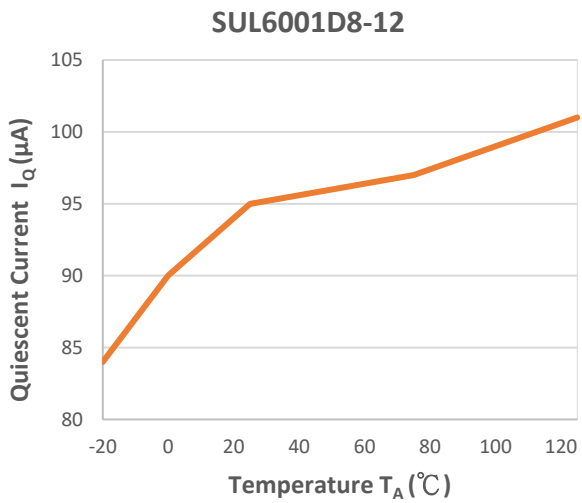

**Over Current Protect Foldback Characteristic (LCON = V<sub>IN</sub>, C<sub>IN</sub> = C<sub>OUT</sub> = 1.0 μF, Ta = 25°C)**

**SUL6001D8-090**

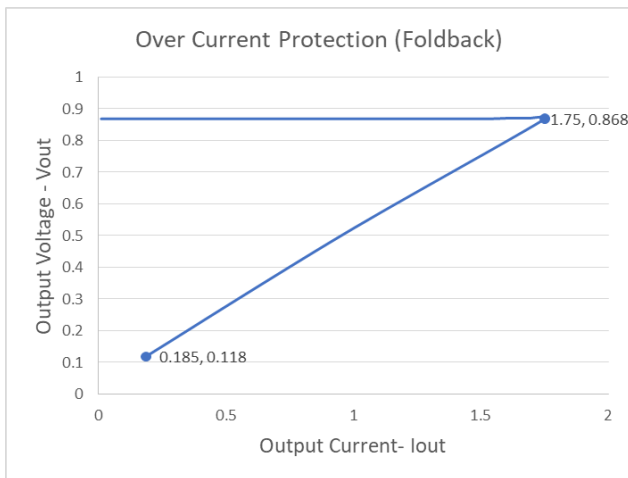

**SUL6001D8-12**

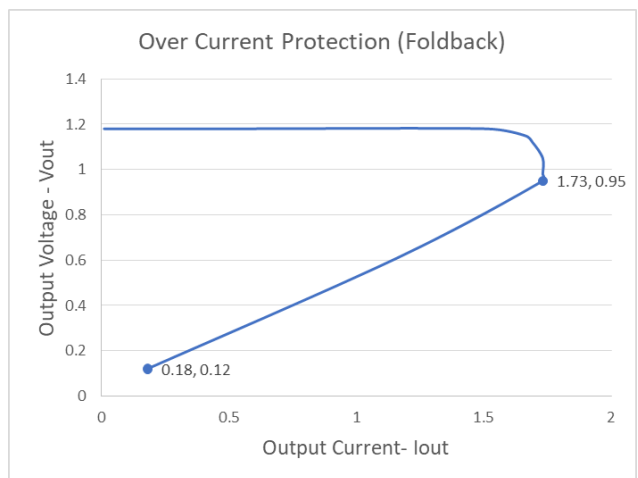

**SUL6001D8-18**

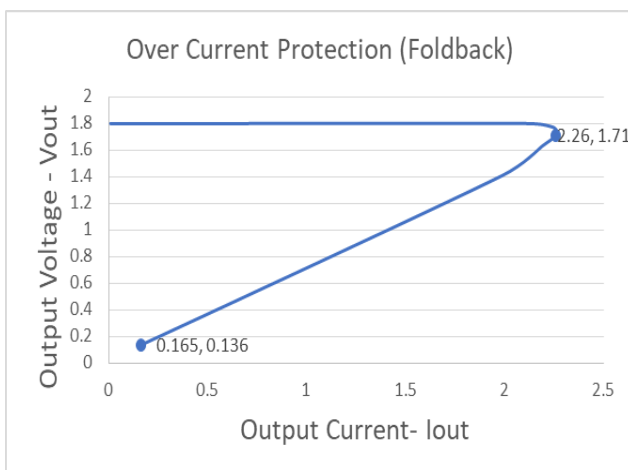

**SUL6001D8-25**

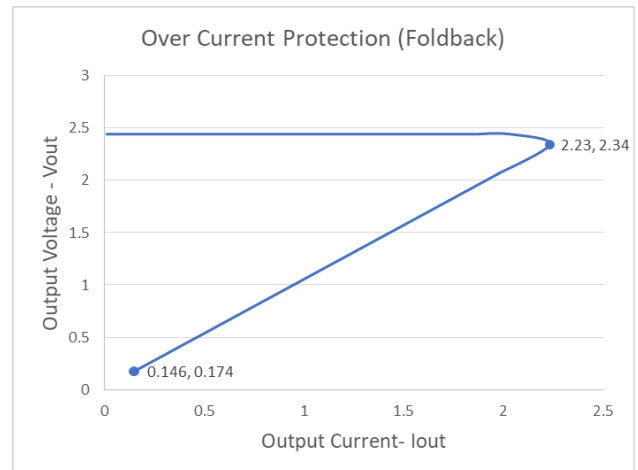

**SUL6001D8-33**

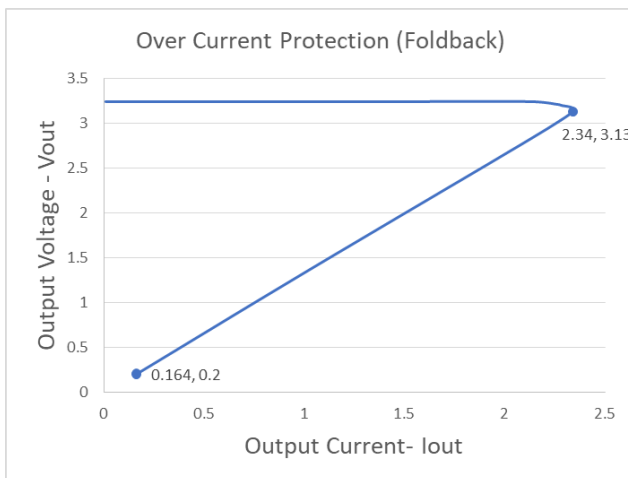

**SUL6001D8-43**

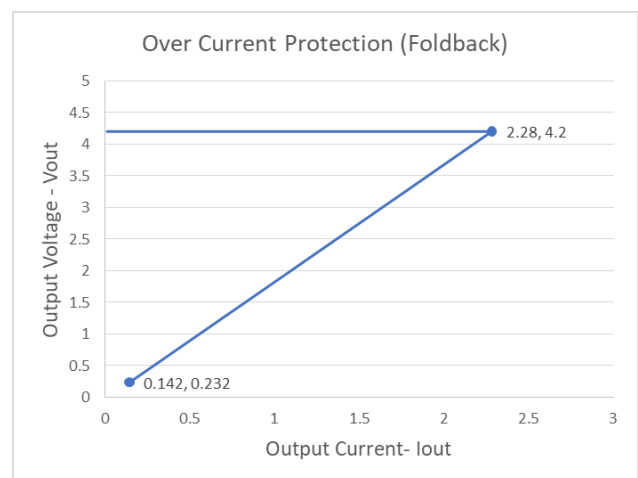

## Output Noise Voltage (10 Hz to 100 kHz, $C_{IN} = C_{OUT} = 1.0 \mu F$ , $T_a = 25^\circ C$ )

**SUL6001D8-090,  $I_{OUT} = 100 \text{ mA}$**

### Amplitude Spectral Density

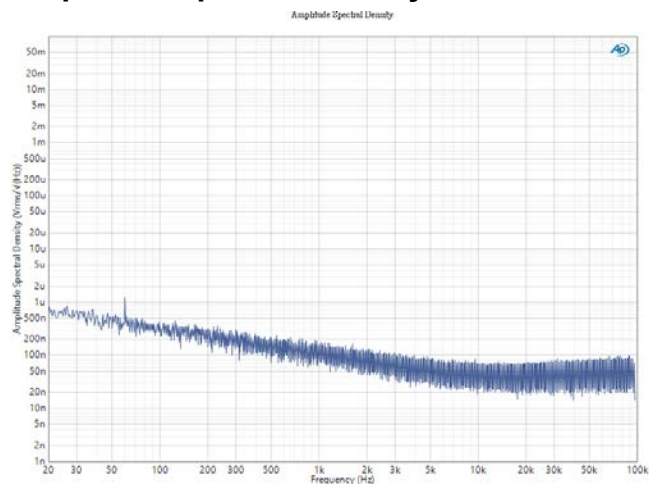

### $V_{RMS}$ from 10 Hz to 100 kHz

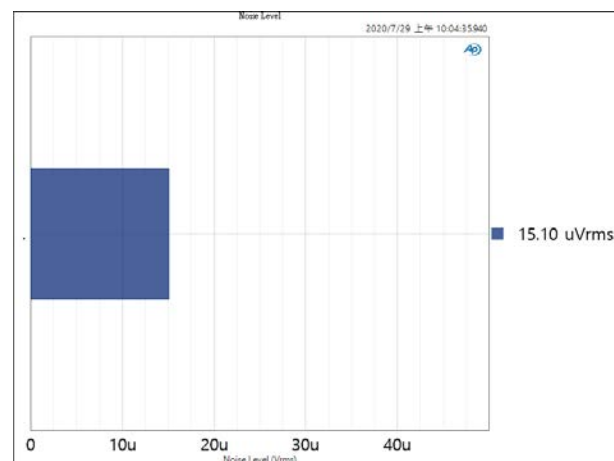

**SUL6001D8-12,  $I_{OUT} = 100 \text{ mA}$**

### Amplitude Spectral Density

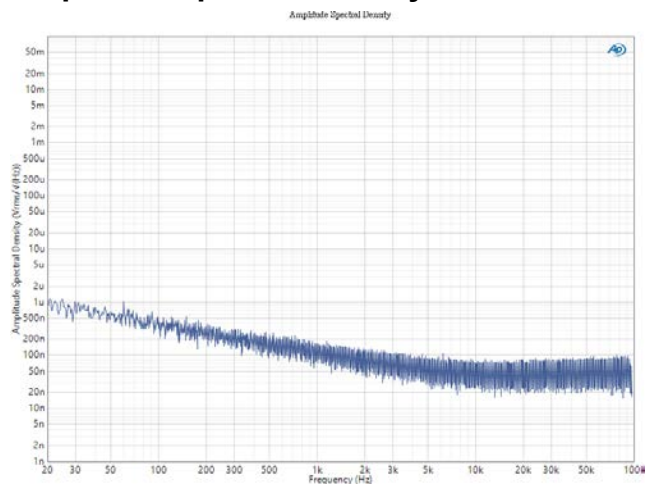

### $V_{RMS}$ from 10 Hz to 100 kHz

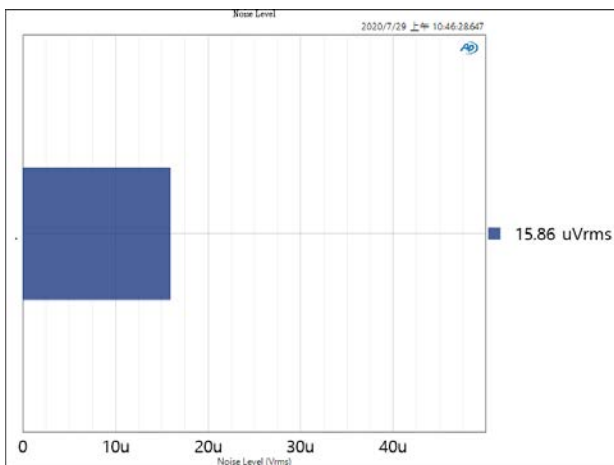

**SUL6001D8-33, I<sub>OUT</sub> = 100 mA**

### Amplitude Spectral Density

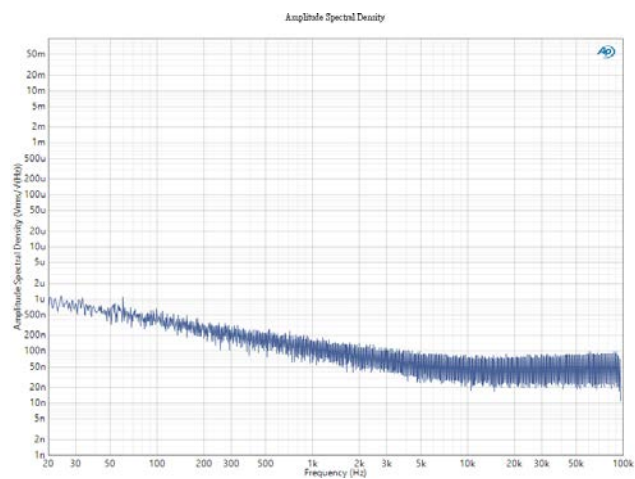

### V<sub>RMS</sub> from 10 Hz to 100 kHz

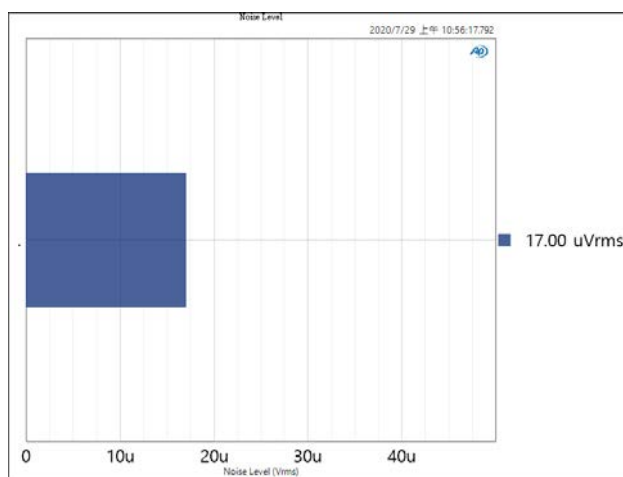

# Power Supply Ripple Rejection vs. Frequency ( $V_{IN}=V_{OUT}+1V$ , $C_{IN} = C_{OUT} = 1.0 \mu F$ , Ripple = 0.2 Vp-p, $T_a = 25^\circ C$ )

## SUL6001D8-090

### $I_{Load}=1mA$

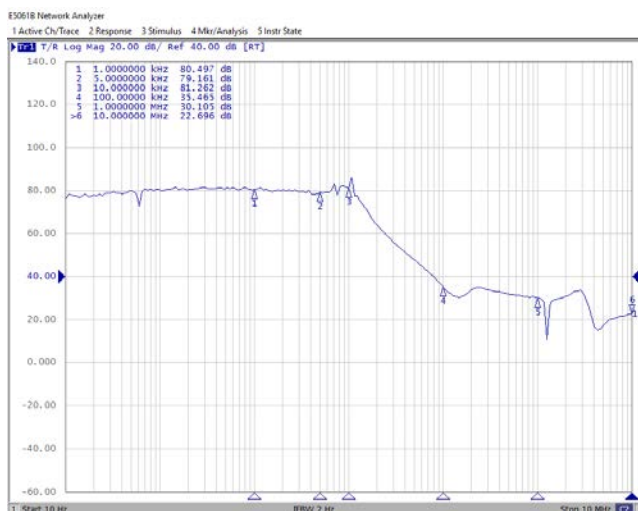

### $I_{Load}=10mA$

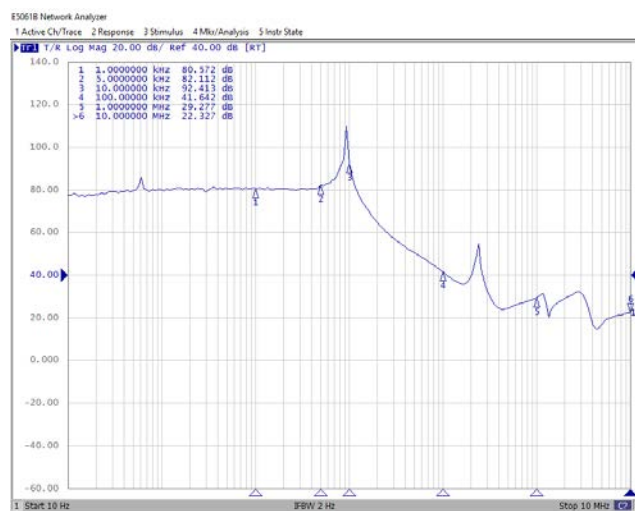

### $I_{Load}=30mA$

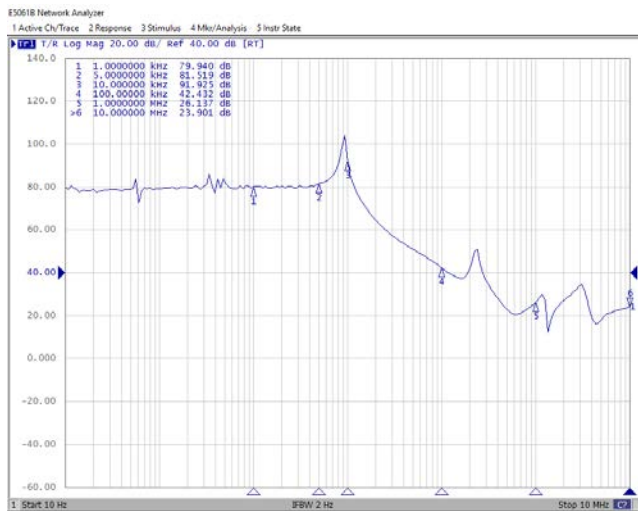

### $I_{Load}=150mA$

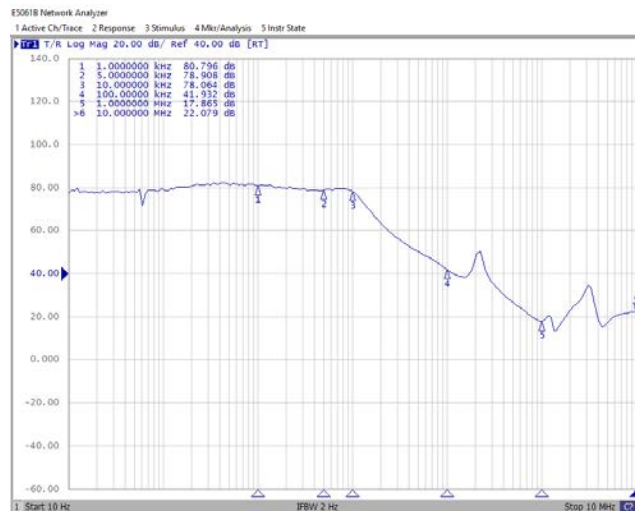

# SUL6001D8-12

## I<sub>Load</sub>=1mA

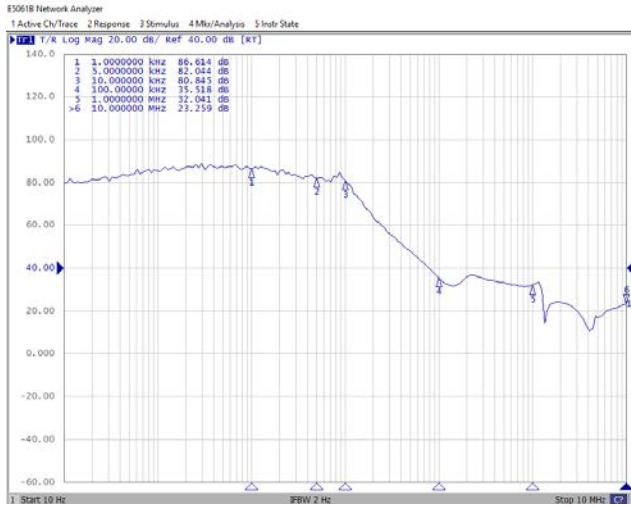

## I<sub>Load</sub>=10mA

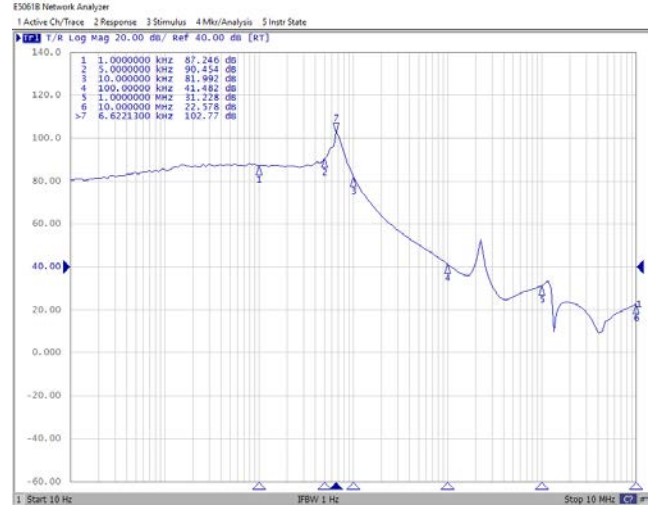

## I<sub>Load</sub>=30mA

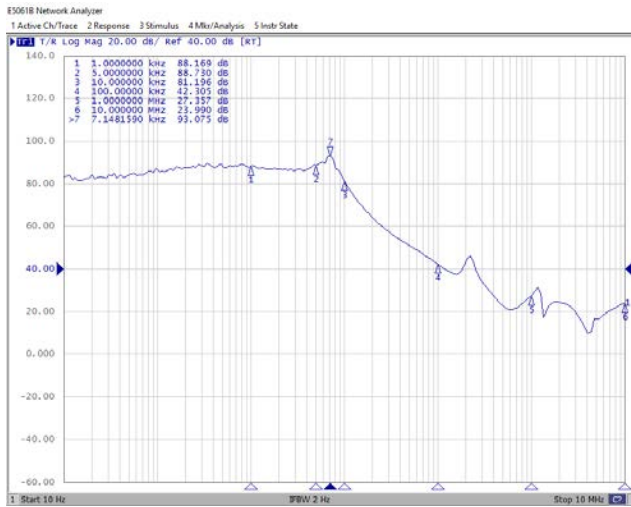

## I<sub>Load</sub>=150mA

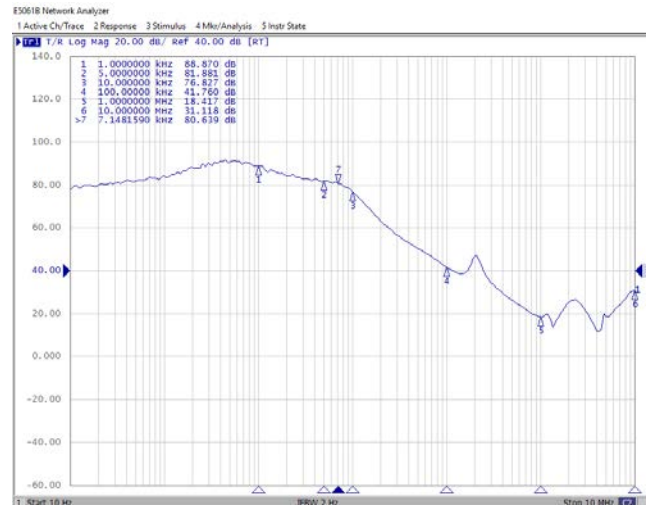

# SUL6001D8-18

## I<sub>Load</sub>=1mA



## I<sub>Load</sub>=10mA

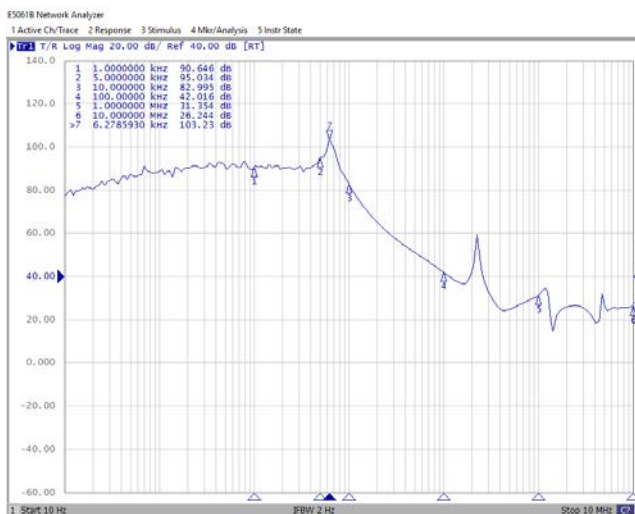

## I<sub>Load</sub>=30mA

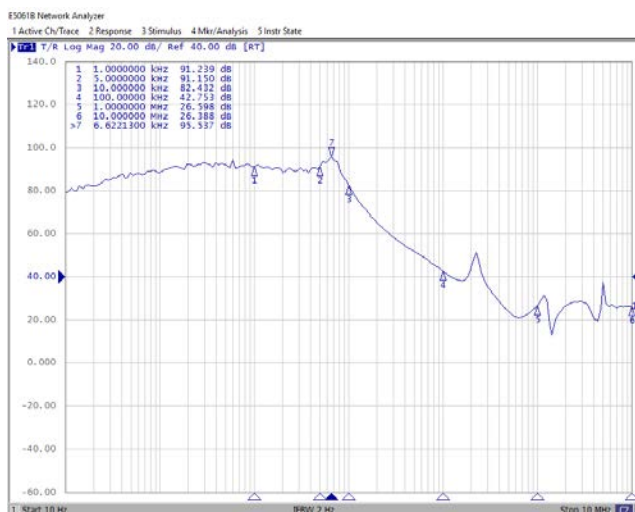

## I<sub>Load</sub>=150mA

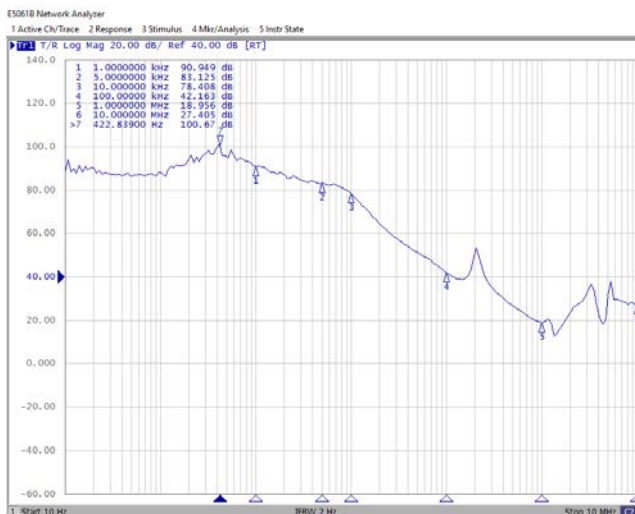

# SUL6001D8-25

## I<sub>Load</sub>=1mA

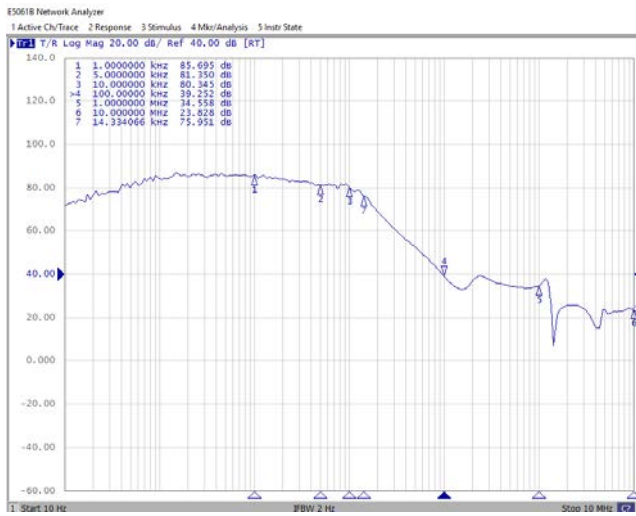

## I<sub>Load</sub>=10mA

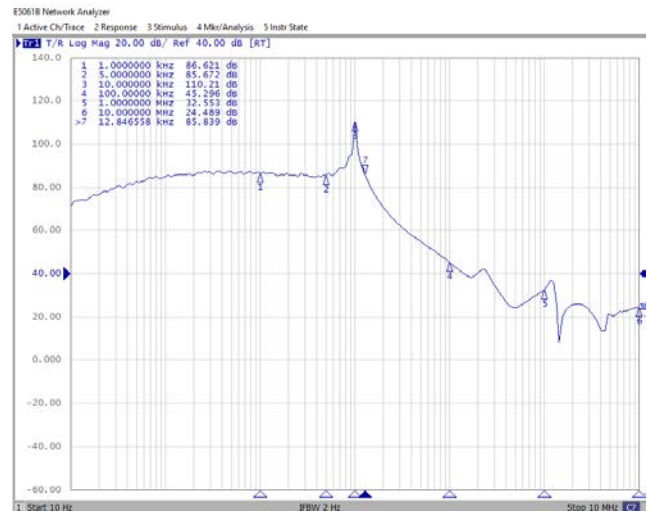

## I<sub>Load</sub>=30mA

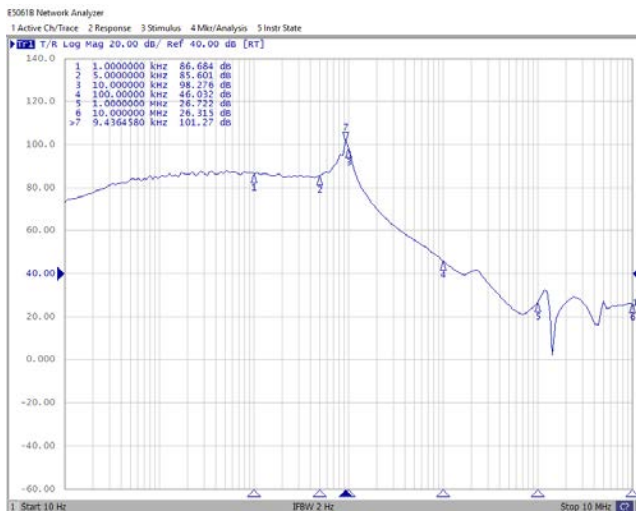

## I<sub>Load</sub>=150mA

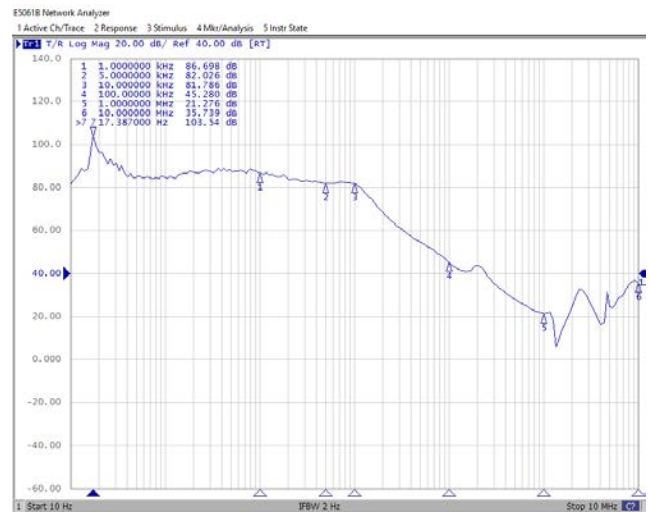



# SUL6001D8-33

## I<sub>Load</sub>=1mA

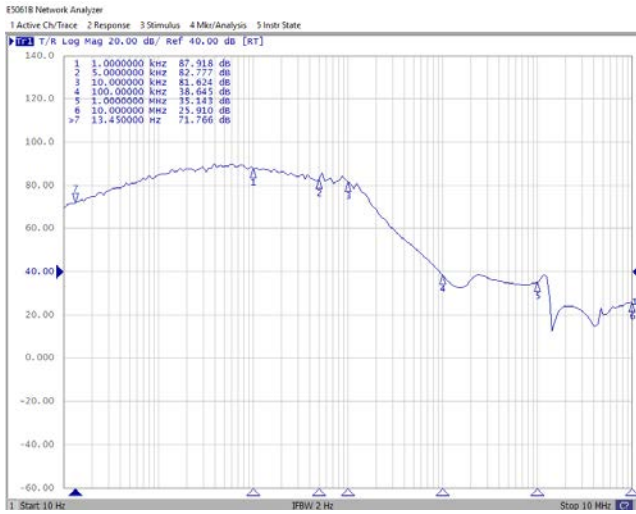

## I<sub>Load</sub>=10mA

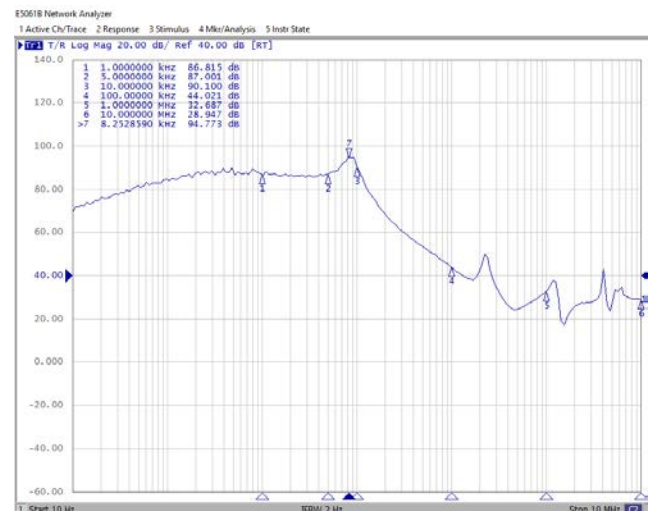

## I<sub>Load</sub>=30mA

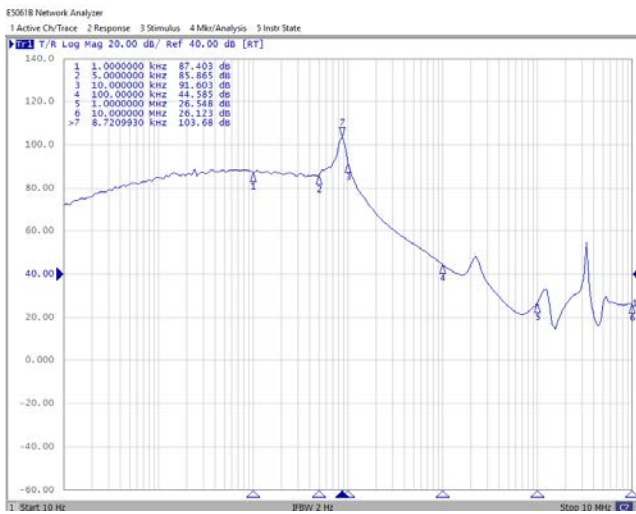

## I<sub>Load</sub>=150mA

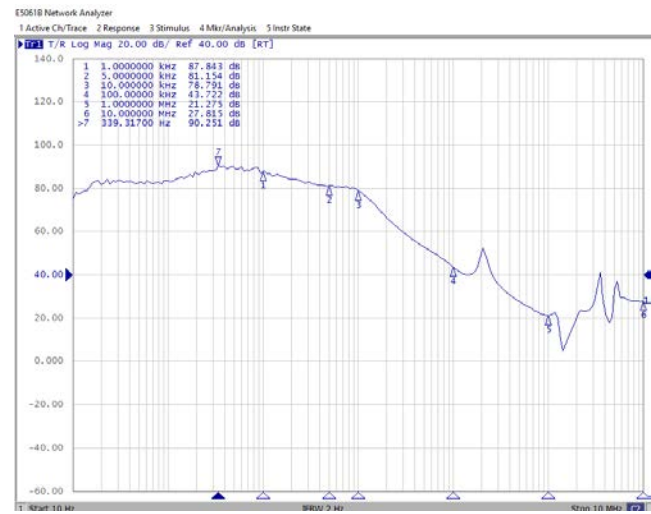

# SUL6001D8-43

## I<sub>Load</sub>=1mA

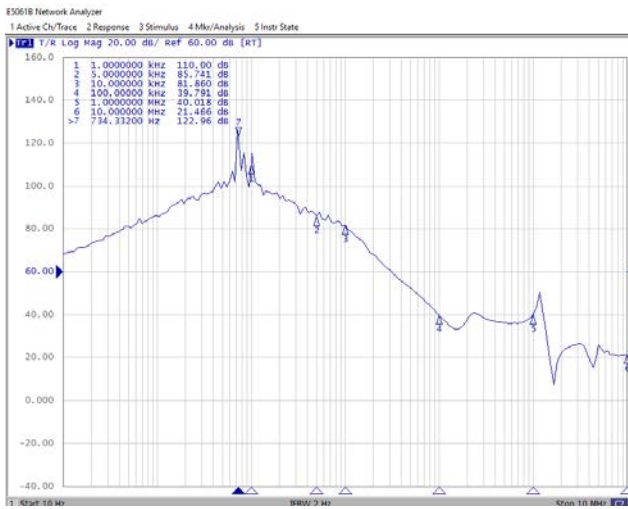

## I<sub>Load</sub>=10mA

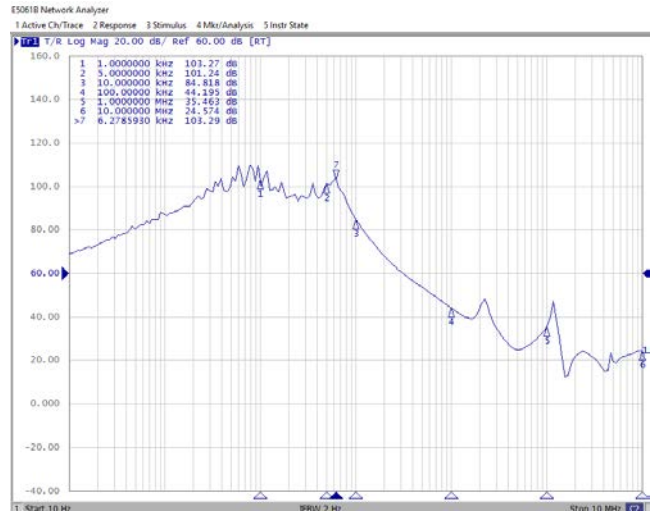

## I<sub>Load</sub>=30mA



## I<sub>Load</sub>=150mA



Load Transient Response ( $V_{IN}=V_{OUT}+1V$ ,  $C_{IN} = C_{OUT} = 1.0 \mu F$ ,  $t_r = t_f = 1 \mu s$ ,  $T_a = 25^\circ C$ )

**SUL6001D8-090**

**1mA -> 250mA**

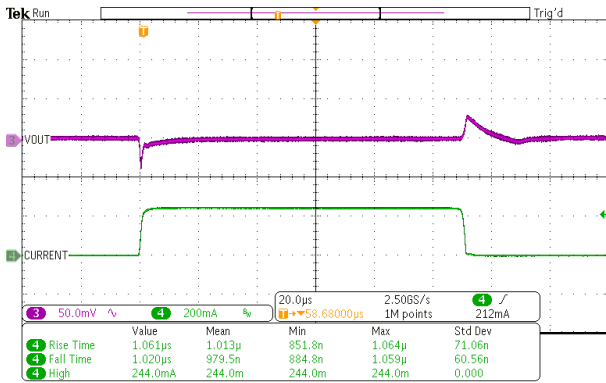

**1mA -> 500mA**

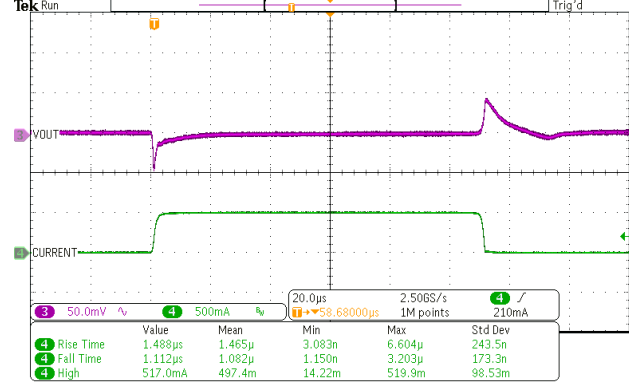

**1mA -> 1000mA**

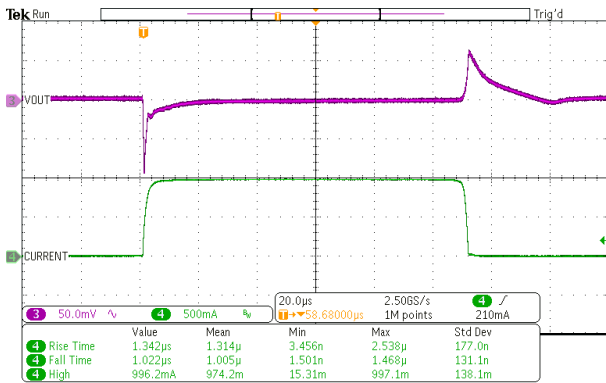

**0mA -> 300mA**

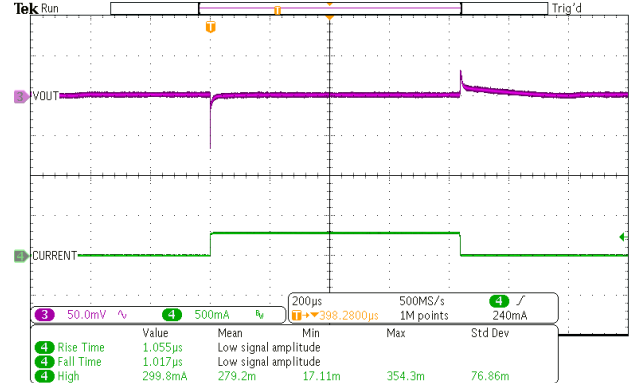

**0mA -> 1000mA**

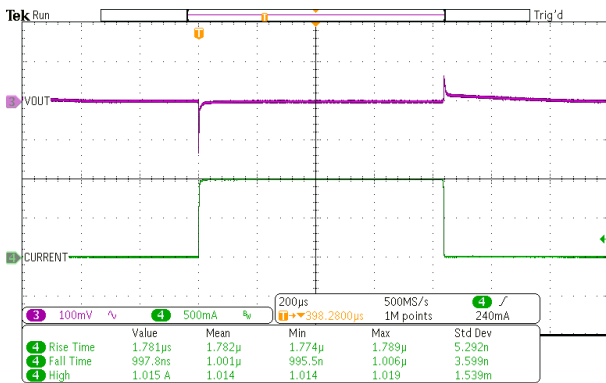

# SUL6001D8-12

## 1mA -> 250mA

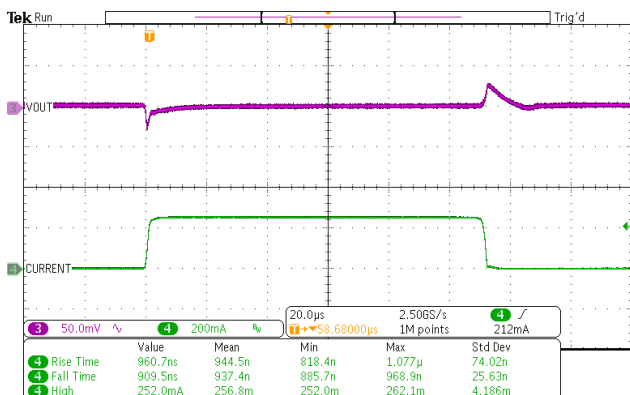

## 1mA -> 500mA

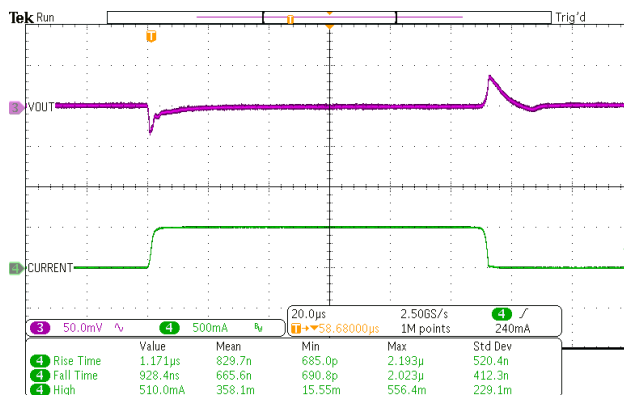

## 1mA -> 1000mA

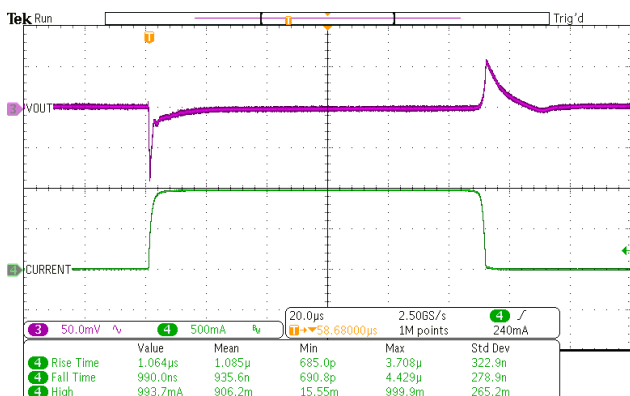

## 0mA -> 300mA

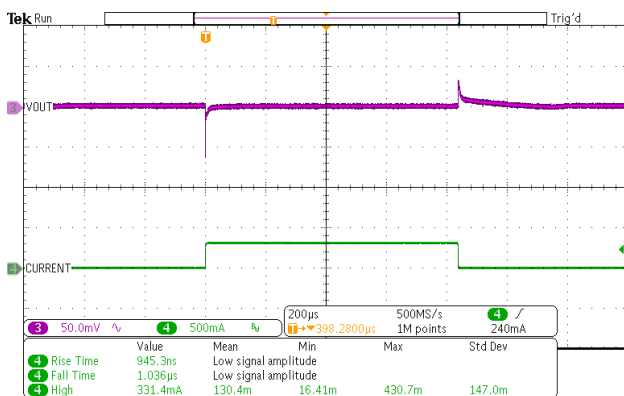

## 0mA -> 1000mA

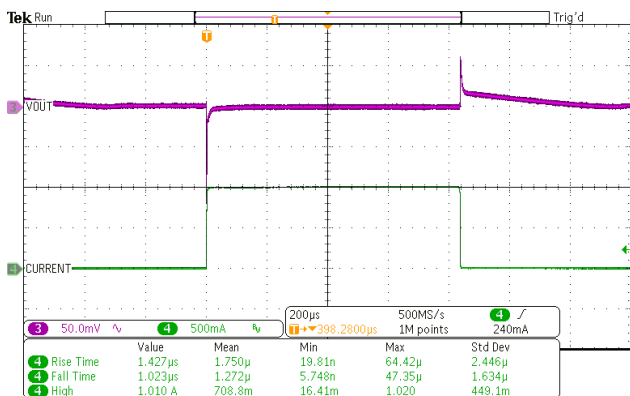

## SUL6001D8-18

### 1mA -> 250mA

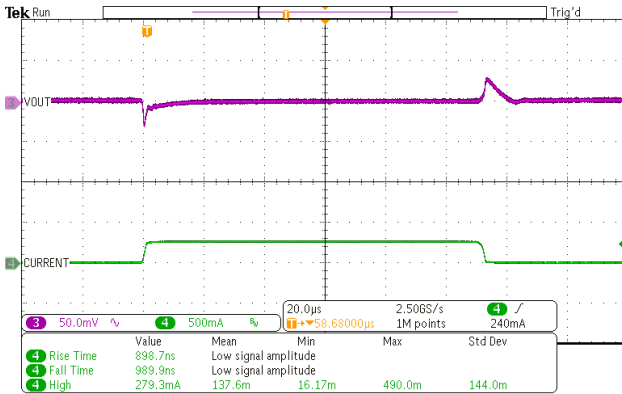

### 1mA -> 500mA

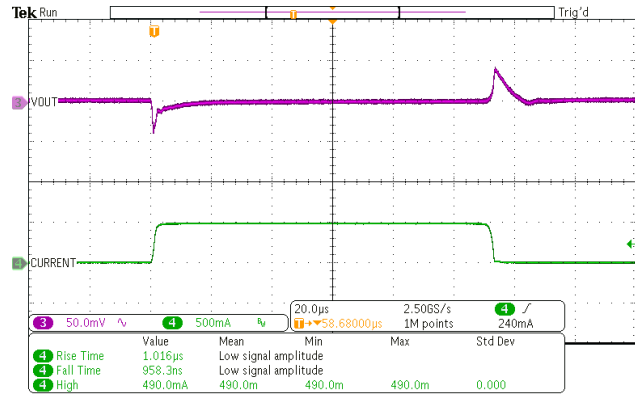

### 1mA -> 1000mA

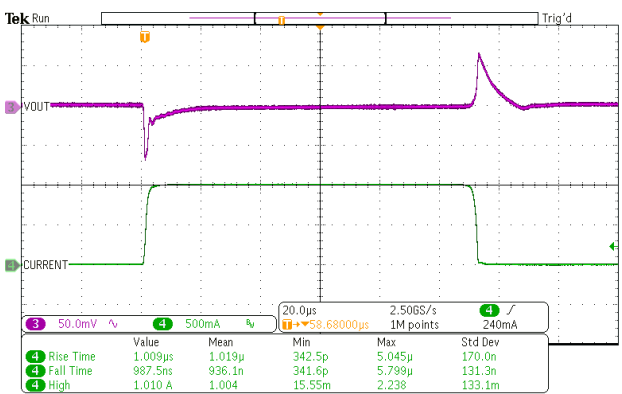

### 0mA -> 300mA

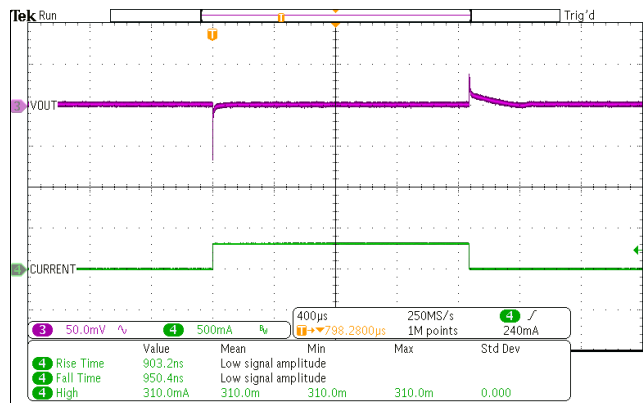

### 0mA -> 1000mA

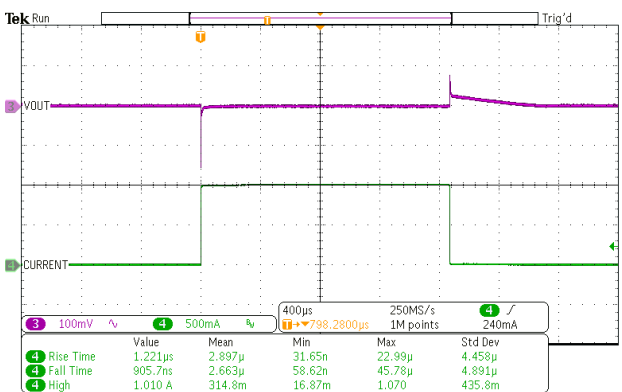

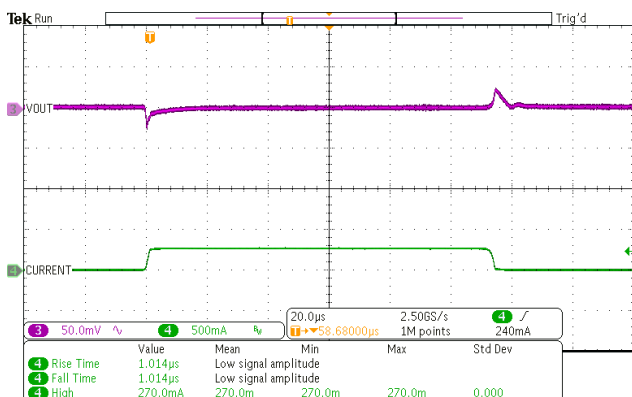
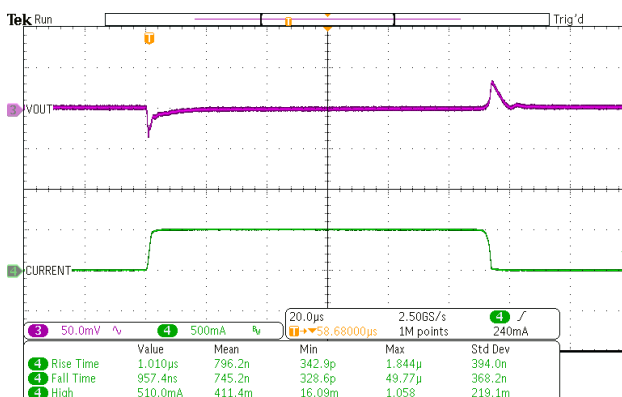
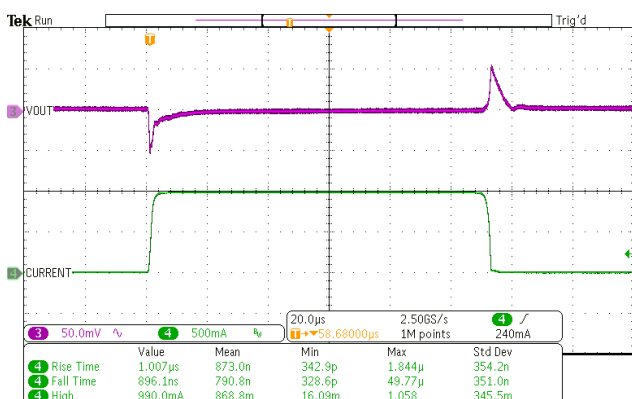
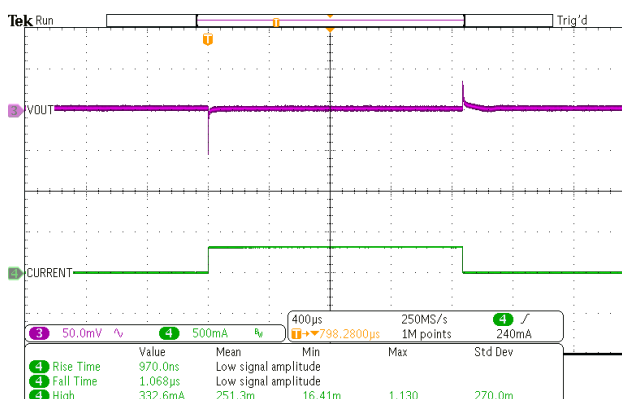
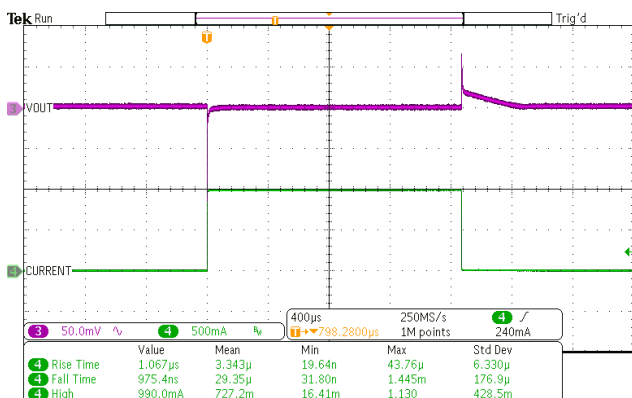
**SUL6001D8-25**
**1mA -> 250mA**

**1mA -> 500mA**

**1mA -> 1000mA**

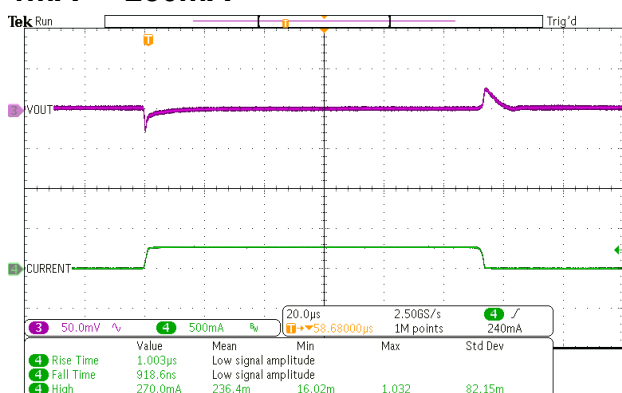
**0mA -> 300mA**

**0mA -> 1000mA**

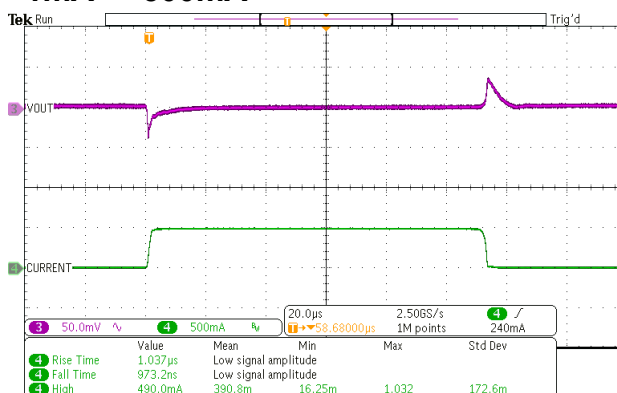
## SUL6001D8-33

### 1mA -> 250mA



### 1mA -> 500mA



### 1mA -> 1000mA

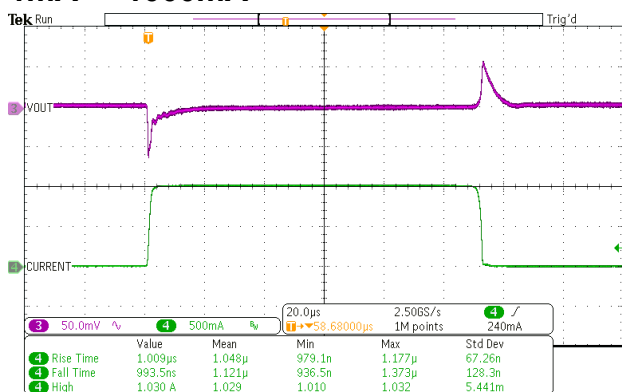

### 0mA -> 300mA

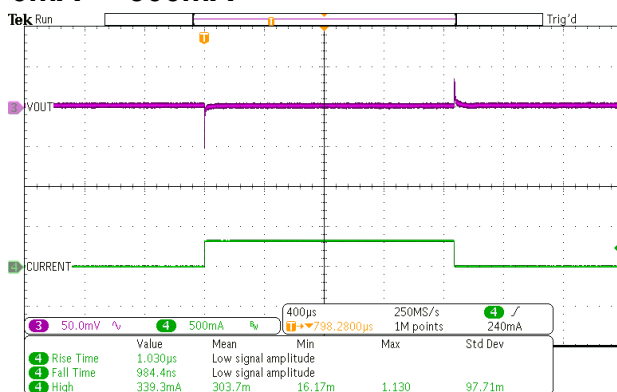

### 0mA -> 1000mA

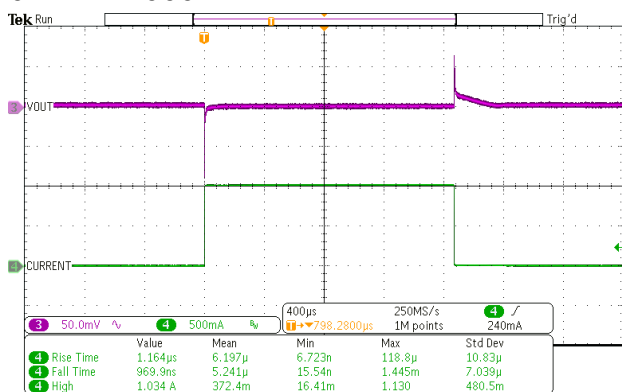

# SUL6001D8-43

## 1mA -> 250mA

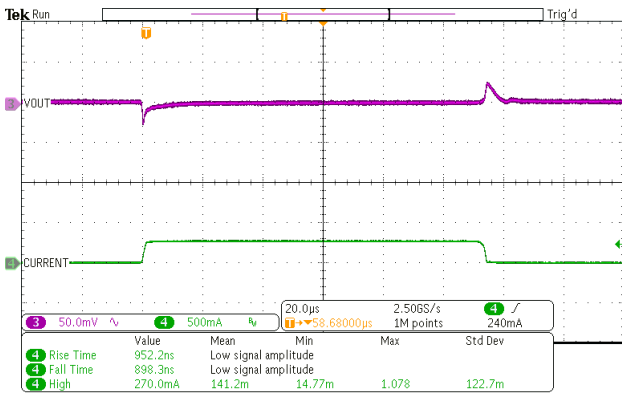

## 1mA -> 500mA

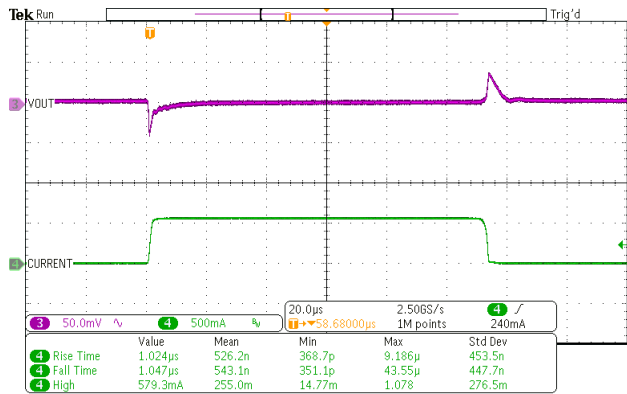

## 1mA -> 1000mA

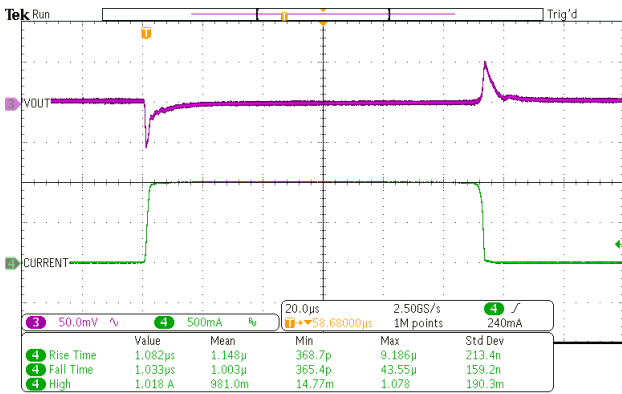

## 0mA -> 300mA

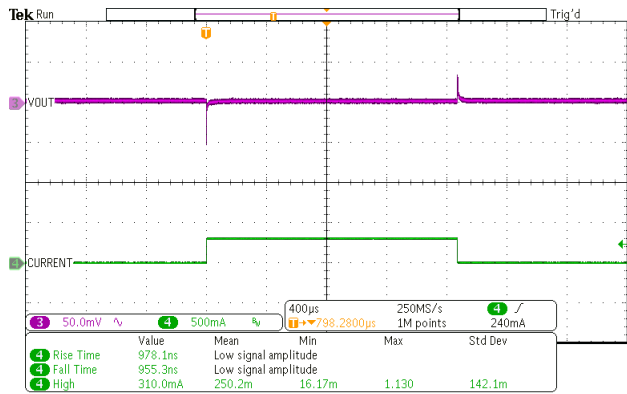

## 0mA -> 1000mA

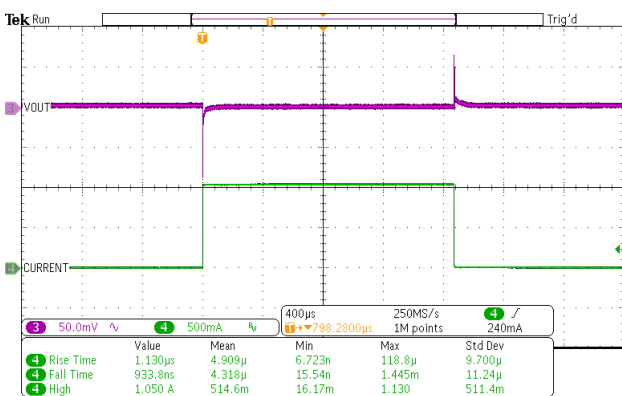



**Turn-on waveform by  $V_{IN}$  &  $CE$  @ light load ( $V_{IN} = CE = 0$  V to  $V_{OUT}+1$ V,  $C_{IN} = C_{OUT} = 1.0$   $\mu$ F,  $T_a = 25^\circ$ C,  $I_{OUT} = 1$  mA)**

**SUL6001D8-090**

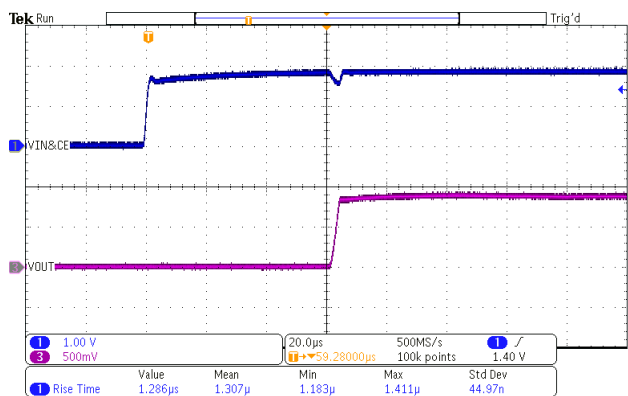

**SUL6001D8-12**

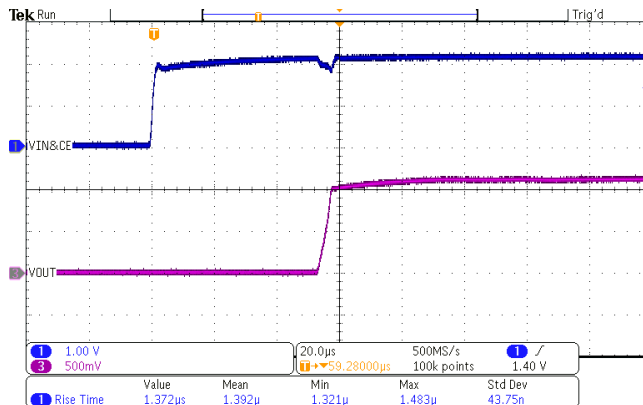

**SUL6001D8-18**

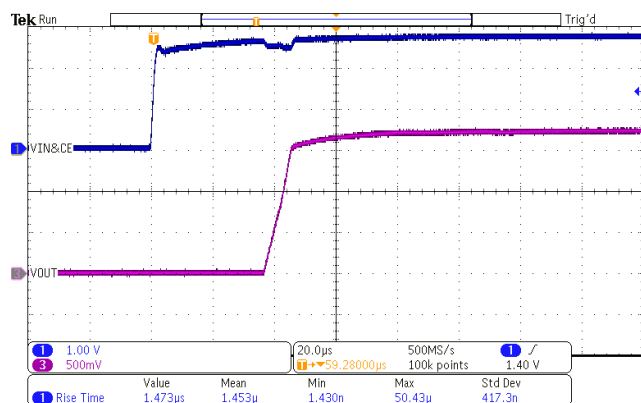

**SUL6001D8-25**

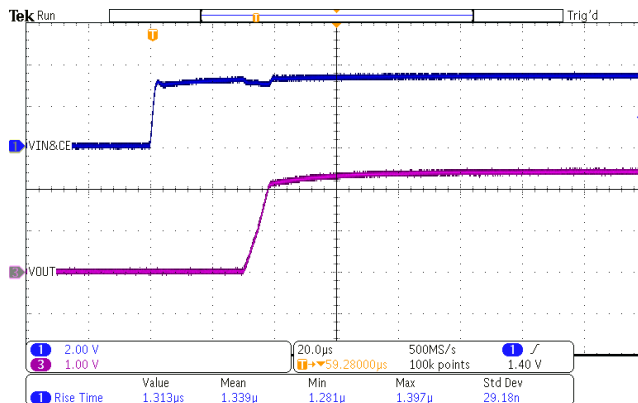

**SUL6001D8-33**

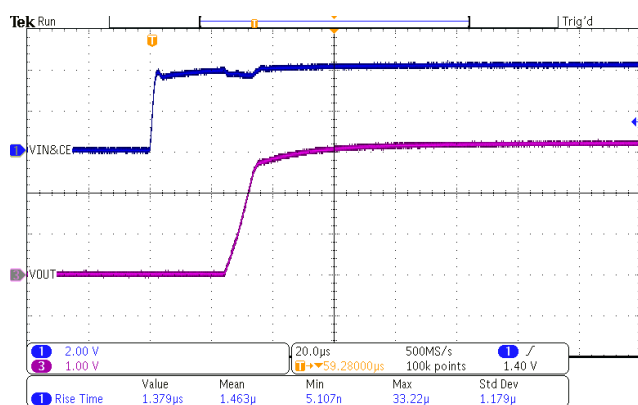

**SUL6001D8-43**

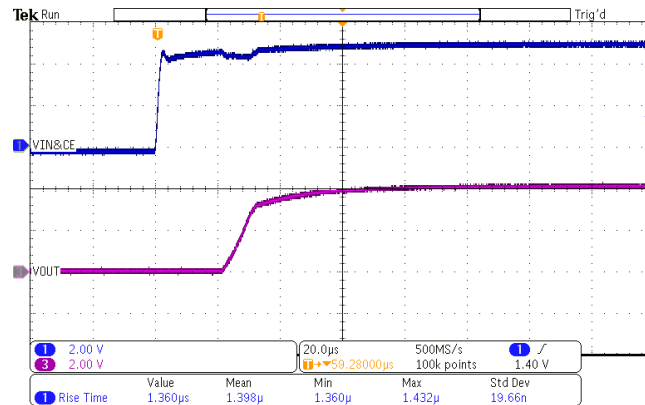

Turn-on waveform by  $V_{IN}$  & CE @ full load ( $V_{IN} = CE = 0\text{ V}$  to  $V_{OUT}+1\text{V}$ ,  $C_{IN} = C_{OUT} = 1.0\ \mu\text{F}$ ,  $T_a = 25^\circ\text{C}$ ,  $I_{OUT}=1\text{A}$ )

**SUL6001D8-09Q**

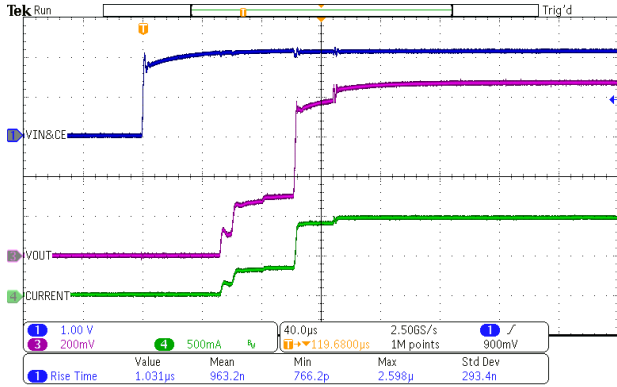

**SUL6001D8-12**

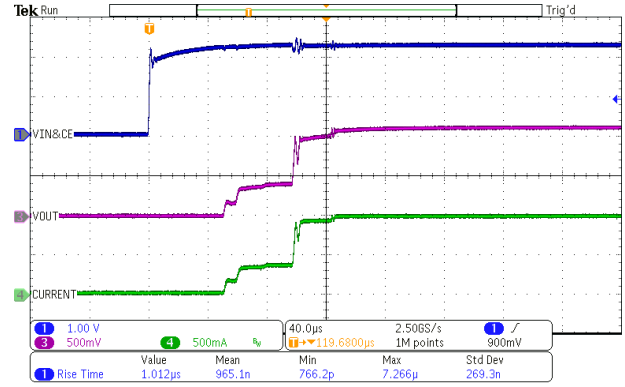

**SUL6001D8-18**

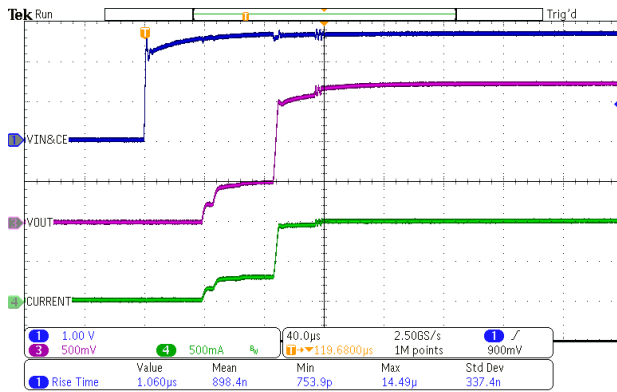

**SUL6001D8-25**

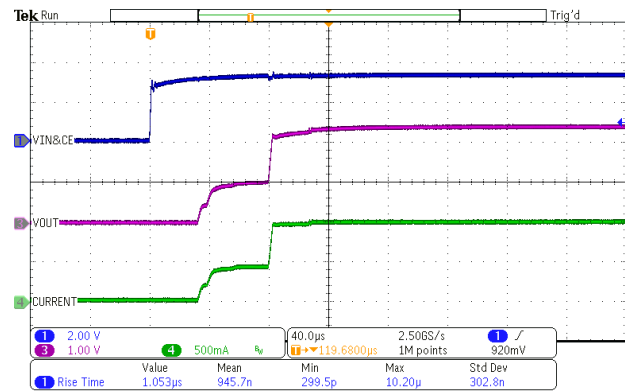

**SUL6001D8-33**

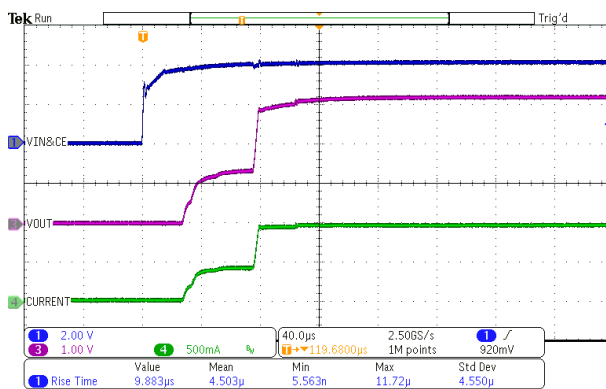

**SUL6001D8-43**

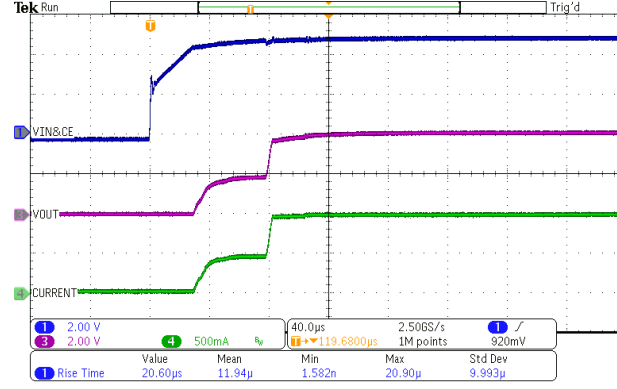

Turn-on by CE pin & Inrush current @ no load ( $V_{IN} = V_{OUT} + 1V$ ,  $CE = 0V$  to  $1V$ ,  $C_{IN} = C_{OUT} = 1.0 \mu F$ ,  $T_a = 25^\circ C$ ,  $I_{OUT} = 0 mA$ )

**SUL6001D8-09**

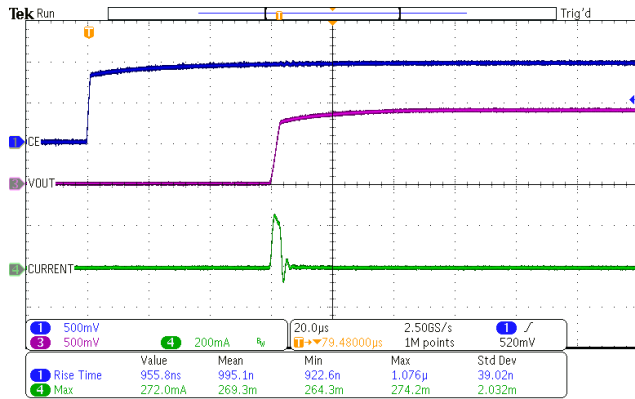

**SUL6001D8-12**

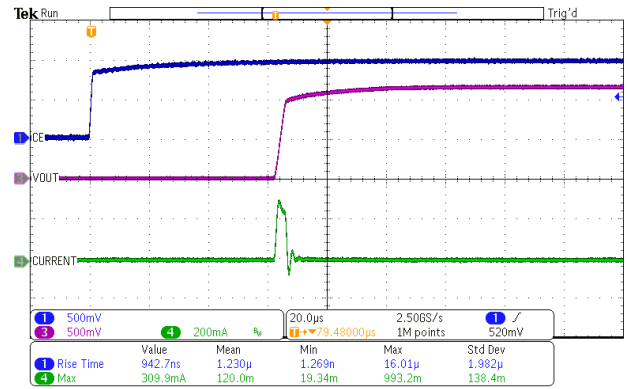

**SUL6001D8-18**

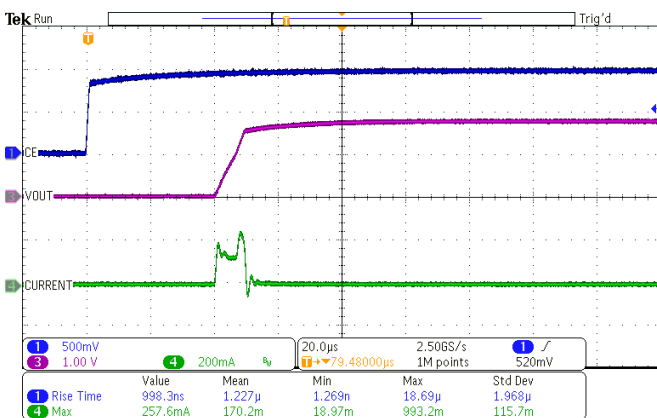

**SUL6001D8-25**

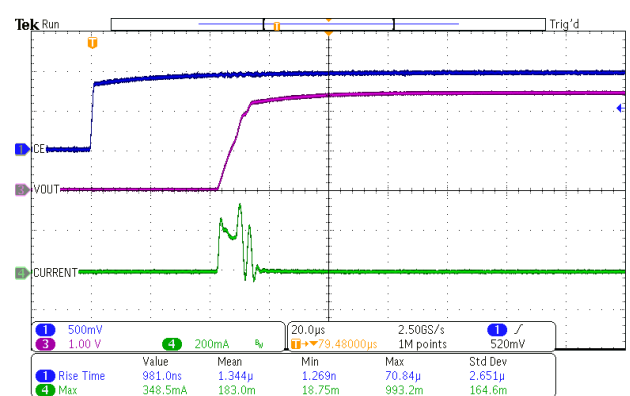

**SUL6001D8-33**

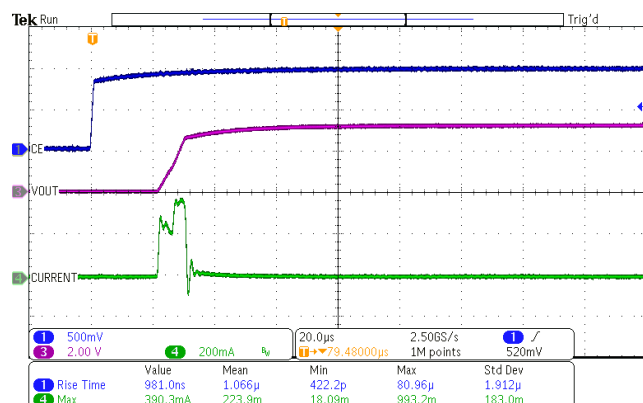

**SUL6001D8-43**

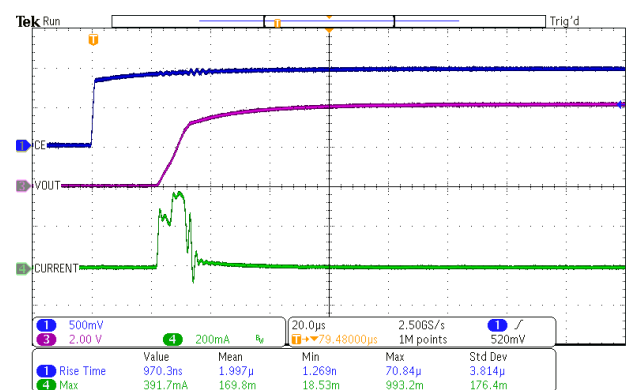

Turn-on by CE pin @ full load ( $V_{IN} = V_{OUT} + 1V$ ,  $CE = 0V$  to  $1V$ ,  $C_{IN} = C_{OUT} = 1.0 \mu F$ ,  $T_a = 25^\circ C$ ,  $I_{OUT} = 1A$ )

**SUL6001D8-090**

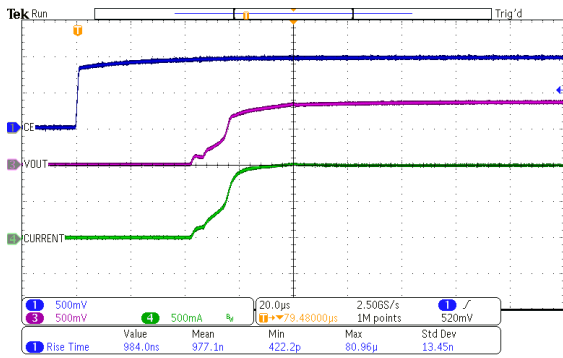

**SUL6001D8-12**

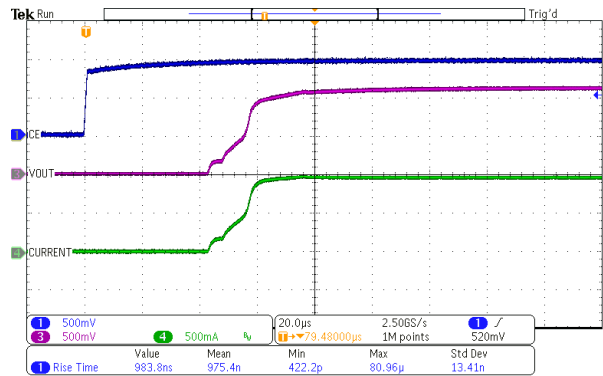

**SUL6001D8-18**

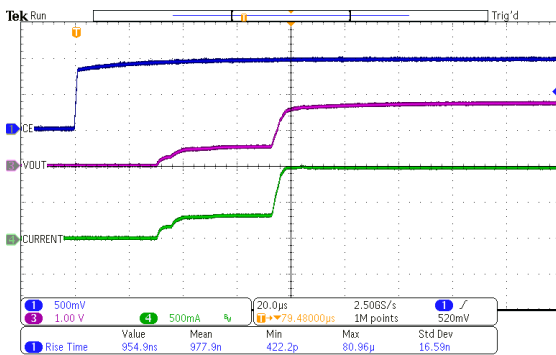

**SUL6001D8-25**

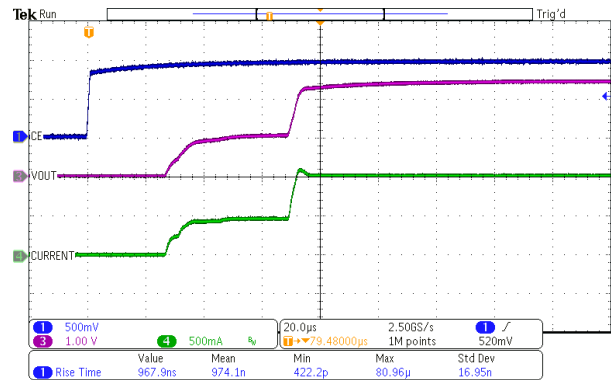

**SUL6001D8-33**

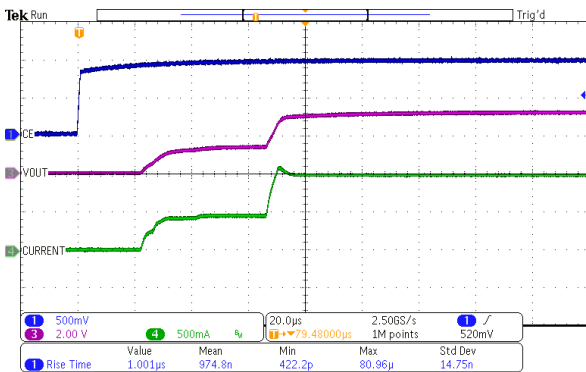

**SUL6001D8-43**

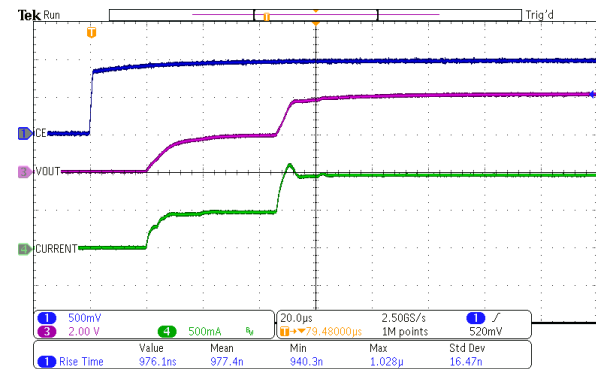

## DFN1216-8 Package Information

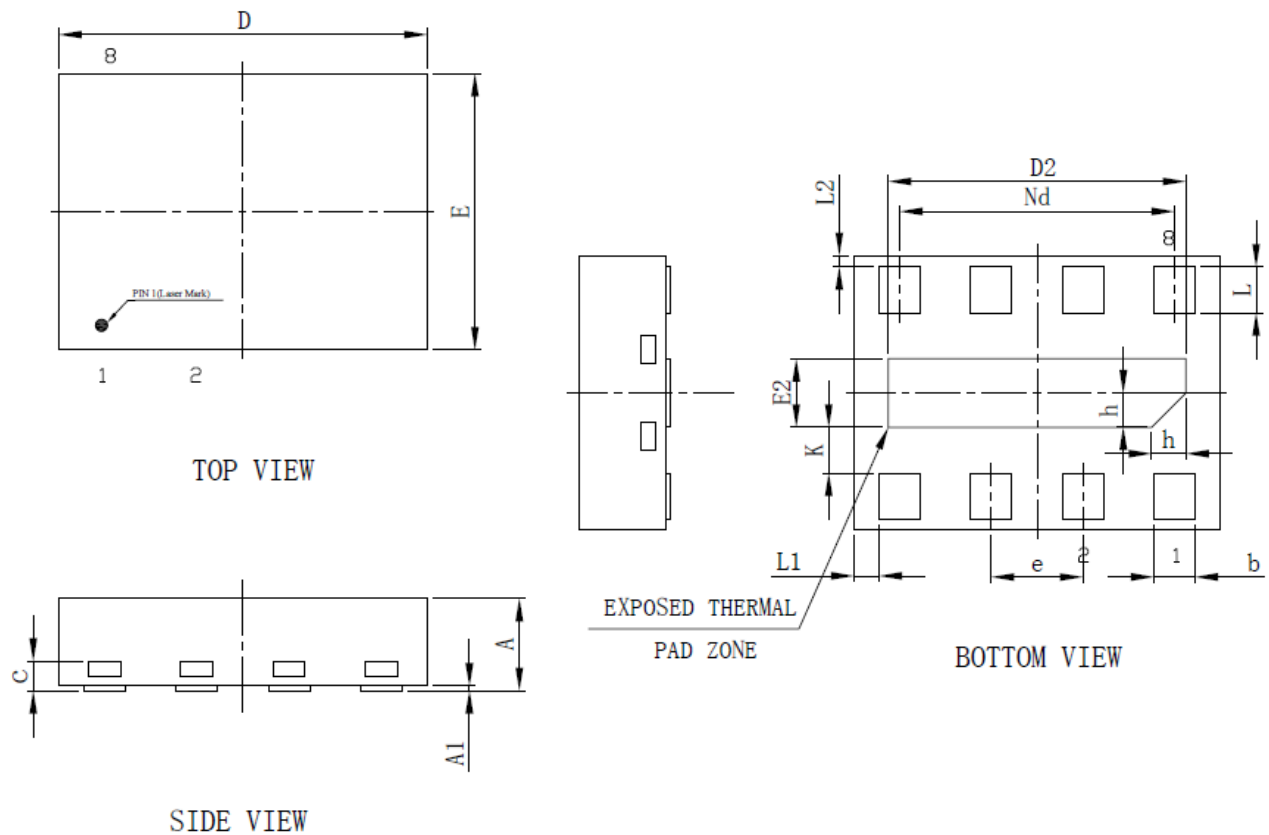

SYMBOL	MILLIMETER		
	MIN	NOM	MAX
A	0.35	-	0.40
A1	0	0.02	0.05
b	0.13	0.18	0.23
c	0.127REF		
D	1.55	1.60	1.65
D2	1.25	1.30	1.35
e	0.40BSC		
Nd	1.20BSC		
E	1.15	1.20	1.25
E2	0.25	0.30	0.35
L	0.15	0.20	0.25
L1	0.06	0.11	0.16
L2	0.05REF		
h	0.10	0.15	0.20
K	0.15	0.20	0.25

## SOT-23-5 Package Information

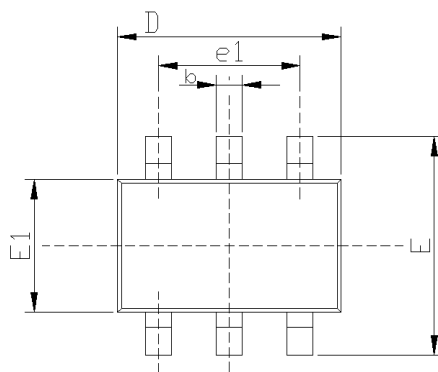
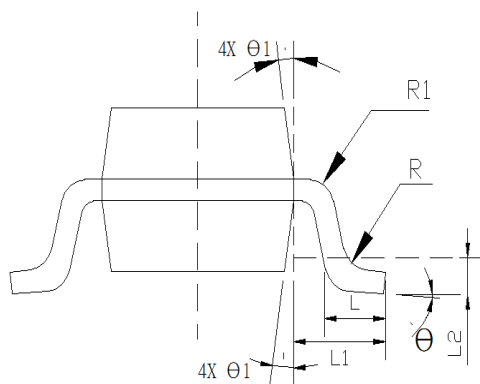
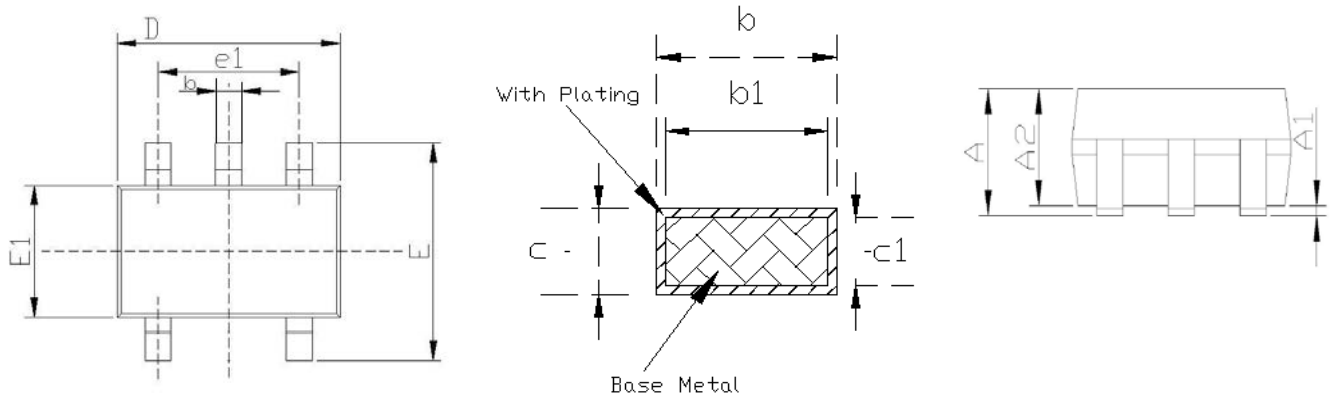

Common Dimensions (Units of Measure=Millimeter)			
SYMBOL	MINIMUM	NOMINAL	MAXIMUM
A	-	-	1.35
A1	0	-	0.15
A2	1.00	1.10	1.20
b	0.35	-	0.45
b1	0.32	-	0.38
c	0.14	-	0.20
c1	0.14	0.15	0.16
D	2.82	2.92	3.02
E	2.60	2.80	3.00
E1	1.526	1.626	1.726
e	0.90	0.95	1.00
e1	1.80	1.90	2.00
L	0.35	0.45	0.60
L1	0.6 REF		
L2	0.25 REF		
R	0.10	-	-
R1	0.10	-	0.25
θ	0°	4°	8°
θ 1	5°	10°	15°

### NOTES:

1. All dimensions refer to standard.
2. Dimensions D does not include mold FLASH.
3. Dimensions E1 does not include mold FLASH.
4. FLASH or protrusion shall not exceed 0.25mm per side.

## SOT-89-5 Package Information

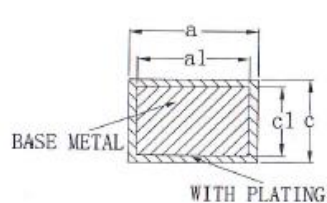
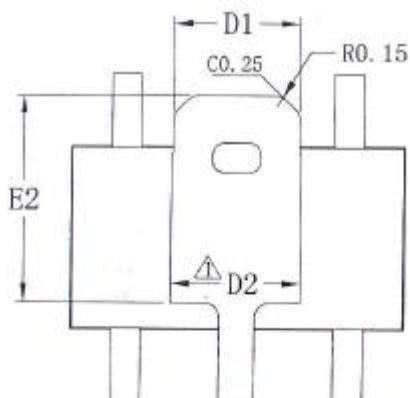

SECTION A-A

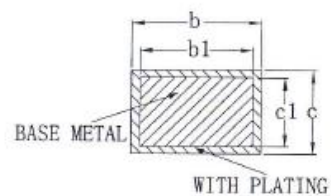

SECTION B-B

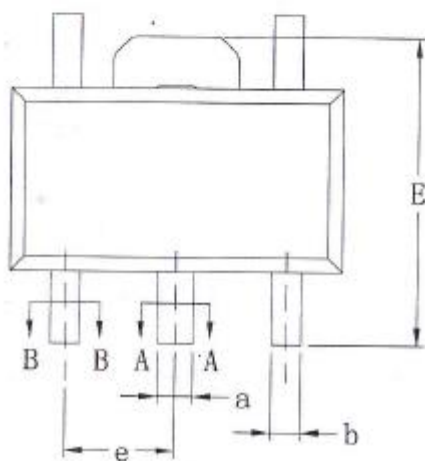
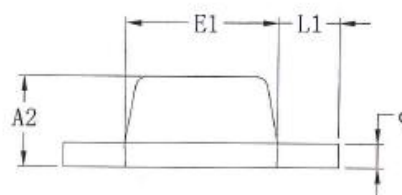
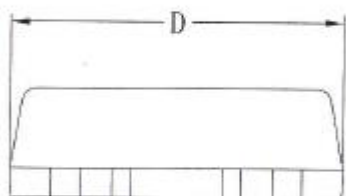

SYMBOL	MILLIMETER		
	MIN	NOM	MAX
A2	1.40	1.50	1.60
b	0.38	—	0.46
b1	0.37	0.40	0.43
c	0.38	—	0.42
c1	0.37	0.38	0.39
a	0.46	—	0.56
a1	0.45	0.48	0.51
D	4.40	4.50	4.60
D1	1.62	—	1.83
E	3.95	—	4.25
E1	2.40	2.50	2.60
e	1.50BSC		
L1	0.89	—	1.20

L/F Size (mil)	Size(mm)	$\triangle$ D2	$\triangle$ E2
85*70		1.75REF	2.84REF

## DFN2020-6 Package Information

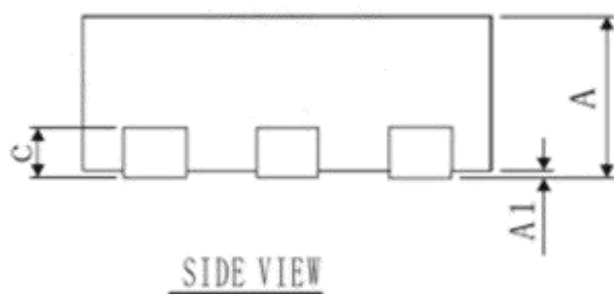
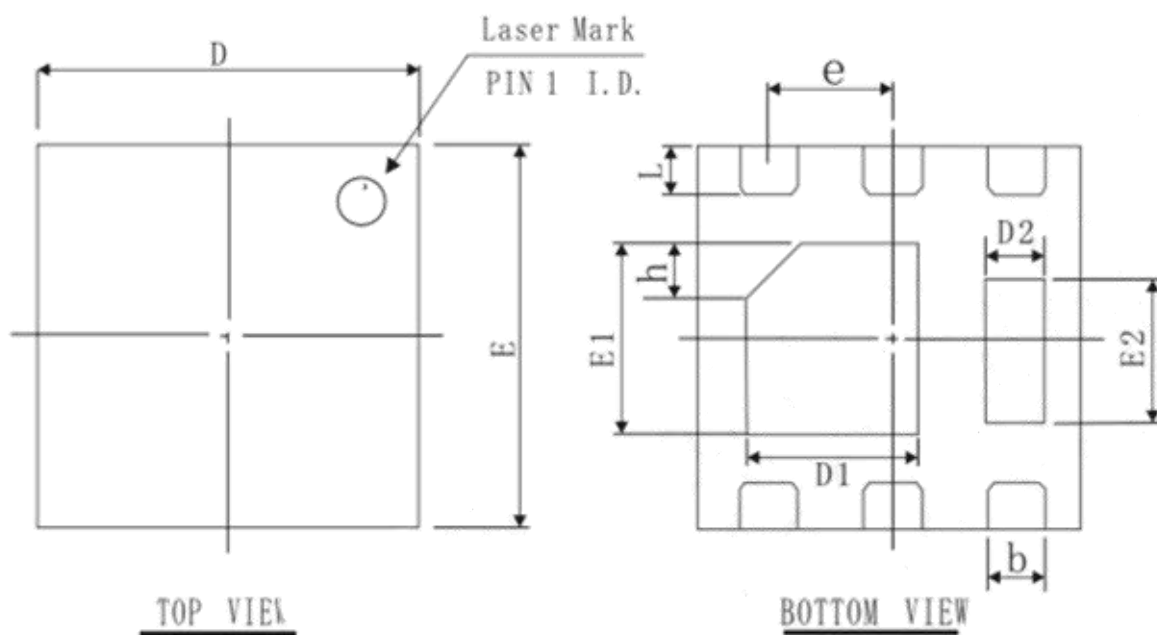

COMMON DIMENSIONS  
(UNITS OF MEASURE=mm)

SYMBOL	MIN	NOM	MAX
A	0.70	0.75	0.80
A1	0.00	0.02	0.05
b	0.20	0.25	0.30
D	1.95	2.00	2.07
E	1.95	2.00	2.07
D1	0.80	0.90	1.00
E1	0.90	1.00	1.10
D2	0.20	0.30	0.40
E2	0.65	0.75	0.85
L	0.20	0.25	0.35
h	0.20	0.25	0.30
c	0.203 REF		
e	0.65 BSC		

其它厚度尺寸如下

A	0.55	0.60	0.65
A	0.50	0.55	0.60



# DFN3030-8 Package Information

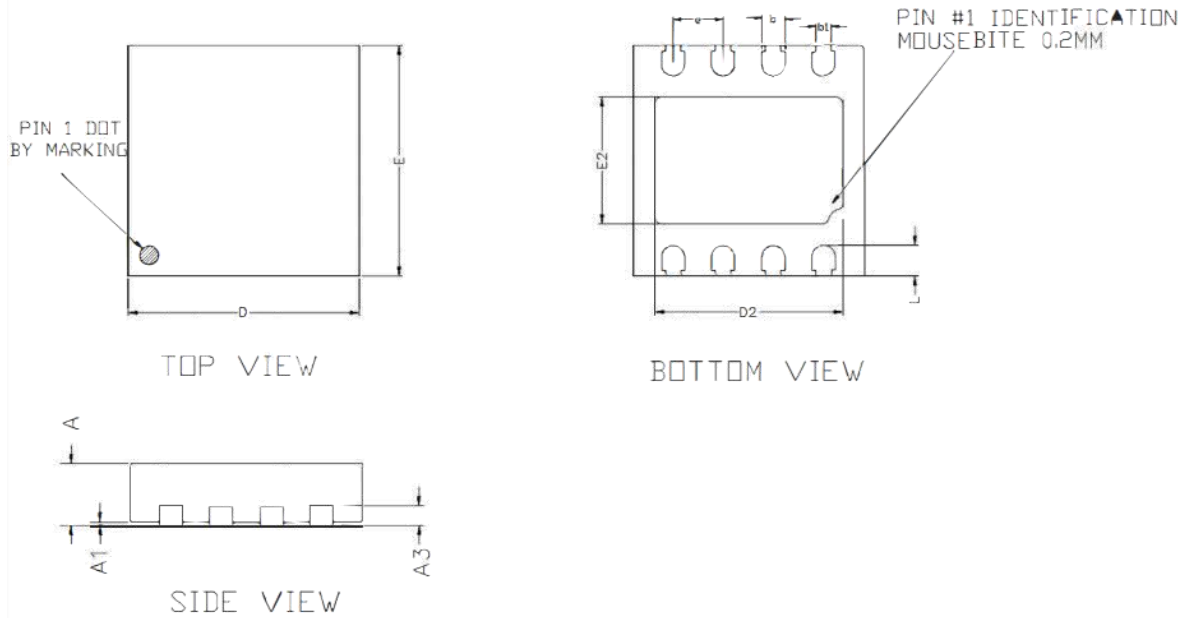

COMMON DIMENSIONS(MM)			
PKG.	W:VERY VERY THIN		
REF.	MIN.	NOM.	MAX
A	0.70	0.75	0.80
A1	0.00	—	0.05
A3	0.2 REF.		
D	2.95	3.00	3.05
E	2.95	3.00	3.05
b	0.25	0.30	0.35
L	0.30	0.40	0.50
D2	2.40	2.45	2.50
E2	1.60	1.65	1.70
e	0.65 BSC		
b1	0.20		

DESIGNED:	DATE: 28/03/09	8L DFN3x3 mm (PACKAGE  OUTLINE)
APPD:	DATE:	
APPD:	DATE:	
APPD:	DATE:	
APPD:	DATE:	
DWG. NO: POD-DFN3030-08L-0.65	REV.: B	SHEET NO : 1 OF 1

啟  
2009

## X-ON Electronics

Largest Supplier of Electrical and Electronic Components

*Click to view similar products for [Linear Voltage Regulators](#) category:*

*Click to view products by [Suntek](#) manufacturer:*

Other Similar products are found below :

[LV5684PVD-XH](#) [MCDTSA6-2R](#) [L7815ACV-DG](#) [714954EB](#) [ZMR500QFTA](#) [BA033LBSG2-TR](#) [LV5680P-E](#) [L79M05T-E](#) [L78LR05D-MA-E](#) [NCV317MBTG](#) [NTE7227](#) [MP2018GZD-33-P](#) [MP2018GZD-5-P](#) [LV5680NPVC-XH](#) [LT1054CN8](#) [ZTS6538SE](#) [UA78L09CLP](#) [UA78L09CLPR](#) [CAT6221-PPTD-GT3](#) [MC78M09CDTRK](#) [NCV51190MNTAG](#) [78M05](#) [HT7150-1](#) [UM1540DB-18](#) [XC6234H281VR-G](#) [WL2834CA-6/TR](#) [TPL730F33-5TR](#) [TLS850F1TA](#) [V50](#) [TPS549B22RVFR](#) [UM1540DB-33](#) [WL9200P3-50B](#) [WL9100P3-33B](#) [WL9005D4-33](#) [XC6219B152MR](#) [WL2855K33-3/TR](#) [PJ54BM33SE](#) [PJ9500M25SA](#) [MD7218E33PC1](#) [H7533-2PR](#) [SK7812AU](#) [SD1A30](#) [78L33](#) [TP78L33T3](#) [L78L33ACUTR](#) [SK6513ST3A-50](#) [SK6054D4-09](#) [SK6054D4-18](#) [SK6054D4-11](#) [SK6054D4-10](#) [LM79L12F](#)