

SUNWAY R CHIP DATASHEET



Thick Film General Purpose SC Series

Tolerance : $\pm 0.1\%$ / $\pm 0.5\%$ / $\pm 1\%$ / $\pm 5\%$

Sizes : 0075 / 01005 / 0201 / 0402 / 0603 / 0805 / 1206 / 1210 / 2010 / 2512

RoHS compliant & Halogen free



CATALOGUE

1. ORDERING INFORMATION.....	1
2. MARKING.....	2
3. CONSTRUCTION AND DIMENSION.....	4
4. ELECTRICAL CHARACTERISTICS.....	5
5. FUNCTIONAL DESCRIPTION.....	7
6. FOOTPRINT AND SOLDERING PROFILES.....	8
7. PACKING STYLE AND PACKAGING QUANTITY.....	12
8. TESTS AND REQUIREMENTS.....	17
9. REVISION HISTORY.....	19
10. SUNWAY CONTACT.....	20

1. ORDERING INFORMATION

SCOPE

This specification describes SC series chip resistors with lead free terminations made by thick film process

APPLICATIONS

All general purpose application

FEATURES

- Halogen Free Epoxy
- RoHS compliant
- Products with lead free terminations meet RoHS requirements
- Pb-glass contained in electrodes, resistors element and glass are exempted by RoHS
- Reducing environmentally hazardous wastes
- High component and equipment reliability Saving of PCB space
- None forbidden-materials used in products/production

NOTE

All our RSMD products meet RoHS compliant and Halogen Free

ORDERING EXAMPLE

The ordering code for a SC0402 0.0625W chip resistor value 100KΩ with ±5% tolerance ,supplied in 7-inch paper tape reel of 10,000 unit per reel is : SC0402J1003F2ANRH

ORDERING INFORMATION-GLOBAL PART NUMBER

Global part numbers are identified by the series, sizes, tolerance ,packing type, temperature coefficient, taping reel and resistance value.

GLOBAL PART NUMBER

SC	XXXX	X	XXXX	X	XX	X	XH
	(1)	(2)	(3)	(4)	(5)	(6)	(7)

(1) SIZE

0075/0100/0201/0402/0603/0805/1206/1210/2010/2512

(2) TOLERANCE

B=±0.1% D=±0.5%
F=±1.0% J=±5.0%

(3) RESISTANCE

There are 2-4digits indicated the resistance value.
Letter R/K/M is decimal point
Example:
9R76 = 9.76 Ω
9761 = 9760 Ω
1004 = 1,000,000 Ω

(4) TEMPERATURE COEFFICIENT OF RESISTANCE

A=±5ppm	B=±10ppm	C=±15ppm
D=±25ppm	E=±50ppm	M=±75ppm
F=±100ppm	L=±150ppm	G=±200ppm
H=±225ppm	I=±300ppm	N=±175ppm
O=±300ppm	J=±350ppm	K=±400ppm
Q=±700ppm		

(5) POWER

1A=1/32W ,1B=1/20W , 1C=1/2W,1D=3/4W,1E=1/50W,
1W=1W,2A=1/16W,2B=1/10W,4A=1/8W,4B=1/5W,8A=1/4W

(6) CONTROL CODE

N:Lead Free, P:Total Lead Free

(7) PACKATING TYPE & PRODUCT CODE

R = 7" Paper tape	P = 10" Paper tape
H = 13" Paper tape	K = 07" Embossed plastic tape
T = 10" Embossed plastic tape	G = 13" Embossed plastic tape
E = ESD safe reel	H = Default code

2. MARKING

Size	Tolerance 1%, 0.5%	Description	Tolerance 5%	Description
SC0075/0100/ 0201/0402		NO marking		NO marking
SC0603		1%, 0.5%, E24 exception values 10/11/13/15/20/75 of E24 series 240=24×10 ⁰ =24		5%, E24 series: 3 digits First two digits for significant figure and 3rd digit for number of zeros 223=22×10 ³ =22K
		1%, 0.5%, E96 refer to EIA-96 marking method ,including values 10/11/13/15/20/75 of E24 series * 29B=196×10=1.96K		
SC0805/1206/ 1210/2010/ 2512		1%, 0.5%, E96 refer to EIA-96 marking method ,including values 10/11/13/15/20/75 of E24 series First three digits for significant figure and 4th digit for number of zeros. 2203=220×10 ³ =220K		5%, E24 series: 3 digits First two digits for significant figure and 3rd digit for number of zeros 223=22×10 ³ =22K

Refer to below table

code	A	B	C	D	E	F	G	H	X	Y	Z
Multiplier	10 ⁰	10 ¹	10 ²	10 ³	10 ⁴	10 ⁵	10 ⁶	10 ⁷	10 ⁻¹	10 ⁻²	10 ⁻³
Value	Code	Value	Code	Value	Code	Value	Code	Value	Code	Value	Code
100	01	147	17	215	33	316	49	464	65	681	81
102	02	150	18	221	34	324	50	475	66	698	82
105	03	154	19	226	35	332	51	487	67	715	83
107	04	158	20	232	36	340	52	499	68	732	84
110	05	162	21	237	37	348	53	511	69	750	85
113	06	165	22	243	38	357	54	523	70	768	86
115	07	169	23	249	39	365	55	536	71	787	87
118	08	174	24	255	40	374	56	549	72	806	88
121	09	178	25	261	41	383	57	562	73	825	89
124	10	182	26	267	42	392	58	576	74	845	90
127	11	187	27	274	43	402	59	590	75	866	91
130	12	191	28	280	44	412	60	604	76	887	92
133	13	196	29	287	45	422	61	619	77	909	93
137	14	200	30	294	46	432	62	634	78	931	94
140	15	205	31	301	47	442	63	649	79	953	95
143	16	210	32	309	48	453	64	665	80	976	96

Values of E3,E6,E12,E24 ,E48& E96

To simplify resistor manufacture, handling, purchase & electronic circuit design, resistor values are arranged into standard resistor values conforming to the E series. The different sets of standard resistor values are known by their E-series numbers: E3 has three resistors in each decade, E6 has six, E12 has twelve, and so forth.

VALUES SERIES

E3	1.0	2.2	4.7												
E6	1.0	1.5	2.2	3.3	4.7	6.8									
E12	1.0	1.2	1.5	1.8	2.2	2.7	3.3	3.9	4.7	5.6	6.8	8.2			
E-24	1.0	1.1	1.2	1.3	1.5	1.6	1.8	2.0	2.2	2.4	2.7	3.0	3.3	3.6	3.9
	4.3	4.7	5.1	5.6	6.2	6.8	7.5	8.2	9.1						
E-48	1.00	1.05	1.10	1.15	1.21	1.27	1.33	1.40	1.47	1.54	1.62	1.69	1.78	1.87	1.96
	2.05	2.15	2.26	2.37	2.49	2.61	2.74	2.87	3.01	3.16	3.32	3.48	3.65	3.83	4.02
	4.22	4.42	4.64	4.87	5.11	5.36	5.62	5.90	6.19	6.49	6.81	7.15	7.50	7.87	8.25
	8.66	9.09	9.53												
E-96	1.00	1.02	1.05	1.07	1.10	1.13	1.15	1.18	1.21	1.24	1.27	1.30	1.33	1.37	1.40
	1.43	1.47	1.50	1.54	1.58	1.62	1.65	1.69	1.74	1.78	1.82	1.87	1.91	1.96	2.00
	2.05	2.10	2.15	2.21	2.26	2.32	2.37	2.43	2.49	2.55	2.61	2.67	2.74	2.80	2.87
	2.94	3.01	3.09	3.16	3.24	3.32	3.40	3.48	3.57	3.65	3.74	3.83	3.92	4.02	4.12
	4.22	4.32	4.42	4.53	4.64	4.75	4.87	4.99	5.11	5.23	5.36	5.49	5.62	5.76	5.90
	6.04	6.19	6.34	6.49	6.65	6.81	6.98	7.15	7.32	7.50	7.68	7.87	8.06	8.25	8.45
	8.66	8.87	9.09	9.31	9.53	9.76									

Preferred value of resistance shall be composed by significant figures shown in the above table and multipliers including: "X10 ohm , X10² ohm , X10³ ohm , X10⁴ ohm , X10⁵ ohm ."

3. CONSTRUCTION AND DIMENSION

CONSTRUCTION

The resistor is constructed on top of a high-grade ceramic body .Internal metal electrodes are added on each end to make the contacts to the thick film resistive element .The composition of the resistive element is a noble metal imbedded into a glass and covered by a second glass to prevent environmental influences .The resistor is laser trimmed to the rated resistance value .The resistor is covered with a protective epoxy coat, finally the two external termination (matte tin on Ni -barrier) are added , as shown in Fig 1 .



Fig1: Chip resistor outlines

DIMENSION

Table 1

TYPE	L(mm)	W(mm)	H(mm)	l1(mm)	l2(mm)
SC0075	0.30±0.01	0.15±0.01	0.13±0.01	0.08±0.03	0.08±0.03
SC0100	0.40±0.02	0.20±0.02	0.13±0.02	0.10±0.03	0.10±0.03
SC0201	0.60±0.03	0.30±0.03	0.23±0.03	0.10±0.05	0.15±0.05
SC0402	1.00±0.05	0.50±0.05	0.35±0.05	0.20±0.10	0.25±0.10
SC0603	1.60±0.10	0.80±0.10	0.45±0.10	0.25±0.15	0.25±0.15
SC0805	2.00±0.10	1.25±0.10	0.50±0.10	0.35±0.20	0.35±0.20
SC1206	3.10±0.10	1.60±0.10	0.55±0.10	0.45±0.20	0.40±0.20
SC1210	3.10±0.10	2.60±0.15	0.55±0.10	0.45±0.15	0.50±0.20
SC2010	5.00±0.10	2.50±0.15	0.55±0.10	0.60±0.20	0.50±0.20
SC2512	6.35±0.10	3.10±0.15	0.55±0.10	0.60±0.20	0.50±0.20

4. ELECTRICAL CHARACTERISTICS

ELECTRICAL CHARACTERISTICS

Table 1

CHARACTERISTICS	POWER	OPERATING TEMPERATURE RANGE	MAXIMUM WORKING VOLTAGE	MAXIMUM OVERLOAD VOLTAGE	DIELECTRIC WITHSTANDING VOLTAGE	RESISTANCE RANGE	TEMPERATURE COEFFICIENT	JUMPER CRITERIA
SC0075	1/50W	-55°C to 125°C	10V	25V	25V	5% (E24) 10Ω≤R≤1MΩ 1% (E24/E96) 10Ω≤R≤1MΩ Jumper≤50mΩ	10Ω≤R≤100Ω ±300ppm°C 100Ω<R≤1MΩ ±200ppm°C	Rated Current 0.5A Maximum Current 1.0A
SC0100	1/32W	-55°C to 125°C	15V	30V	30V	5% (E24) 1Ω≤R≤22MΩ 1% (E24/E96) 1Ω≤R≤10MΩ 0.5% (E24/E96) 10Ω≤R≤1MΩ Jumper≤50mΩ	1Ω≤R≤100Ω ±300ppm°C 100Ω<R≤22MΩ ±200ppm°C	Rated Current 0.5A Maximum Current 1.0A
SC0201	1/20W	-55°C to 125°C	25V	50V	50V	5% (E24) 1Ω≤R≤10MΩ 1% (E24/E96) 1Ω≤R≤10MΩ 0.5% (E24/E96) 1Ω≤R≤1MΩ 0.1% (E24/E96) 10Ω≤R≤1MΩ Jumper≤50mΩ	1Ω≤R≤10Ω ±300ppm°C 10Ω<R≤10MΩ ±200ppm°C	Rated Current 0.5A Maximum Current 1.0A
SC0402	1/16W	-55°C to 155°C	50V	100V	100V	5% (E24) 1Ω≤R≤22MΩ 1% (E24/E96) 1Ω≤R≤10MΩ 0.5% (E24/E96) 1Ω≤R≤1MΩ 0.1% (E24/E96) 10Ω≤R≤1MΩ Jumper≤50mΩ	1Ω≤R≤10Ω ±200ppm°C 10Ω<R≤10MΩ ±100ppm°C 10MΩ<R≤22MΩ ±200ppm°C	Rated Current 1.0A Maximum Current 2.0A
	1/8W	-55°C to 155°C	50V	100V	100V	5% (E24) 1Ω≤R≤1MΩ 1% (E24/E96) 1Ω≤R≤1MΩ	1Ω≤R≤1MΩ ±200ppm°C	
SC0603	1/10W	-55°C to 155°C	75V	150V	150V	5% (E24) 1Ω≤R≤22MΩ 1% (E24/E96) 1Ω≤R≤10MΩ 0.5% (E24/E96) 1Ω≤R≤1MΩ 0.1% (E24/E96) 10Ω≤R≤1MΩ Jumper≤50mΩ	1Ω≤R≤10Ω ±200ppm°C 10Ω<R≤10MΩ ±100ppm°C 10MΩ<R≤22MΩ ±200ppm°C	Rated Current 1.0A Maximum Current 2.0A
	1/5W	-55°C to 155°C	75V	150V	150V	5% (E24) 1Ω≤R≤1MΩ 1% (E24/E96) 1Ω≤R≤1MΩ	1Ω≤R≤1MΩ ±200ppm°C	

ELECTRICAL CHARACTERISTICS

Table 2

CHARACTERISTICS	POWER	OPERATING TEMPERATURE RANGE	MAXIMUM WORKING VOLTAGE	MAXIMUM OVERLOAD VOLTAGE	DIELECTRIC WITHSTANDING VOLTAGE	RESISTANCE RANGE	TEMPERATURE COEFFICIENT	JUMPER CRITERIA
SC0805	1/8W	-55°C to 155°C	150V	300V	300V	5% (E24) 1Ω≤R≤100MΩ 1% (E24/E96) 1Ω≤R≤10MΩ 0.5% (E24/E96) 1Ω≤R≤1MΩ 0.1% (E24/E96) 10Ω≤R≤1MΩ 10%, 20% 24MΩ≤R≤100MΩ Jumper≤50mΩ	1Ω≤R≤10Ω ±200ppm°C 10Ω<R≤10MΩ ±100ppm°C 10MΩ<R≤22MΩ ±200ppm°C 24MΩ≤R≤100MΩ ±300ppm°C	Rated Current 2.0A Maximum Current 5.0A
	1/4W	-55°C to 155°C	150V	300V	300V	5% (E24) 1Ω≤R≤1MΩ 1% (E24/E96) 1Ω≤R≤1MΩ	1Ω≤R≤1MΩ ±200ppm°C	
SC1206	1/4W	-55°C to 155°C	200V	400V	500V	5% (E24) 1Ω≤R≤100MΩ 1% (E24/E96) 1Ω≤R≤10MΩ 0.5% (E24/E96) 1Ω≤R≤1MΩ 0.1% (E24/E96) 10Ω≤R≤1MΩ 10%, 20% 24MΩ≤R≤100MΩ Jumper≤50mΩ	1Ω≤R≤10Ω ±200ppm°C 10Ω<R≤10MΩ ±100ppm°C 10MΩ<R≤22MΩ ±200ppm°C 24MΩ≤R≤100MΩ ±300ppm°C	Rated Current 2.0A Maximum Current 10.0A
	1/2W	-55°C to 155°C	200V	400V	500V	5% (E24) 1Ω≤R≤1MΩ 1% (E24/E96) 1Ω≤R≤1MΩ	1Ω≤R≤1MΩ ±200ppm°C	
SC1210	1/2W	-55°C to 155°C	200V	500V	500V	5% (E24) 1Ω≤R≤22MΩ 1% (E24/E96) 1Ω≤R≤10MΩ 0.1%,0.5% (E24/E96) 10Ω≤R≤1MΩ Jumper≤50mΩ	1Ω≤R≤10Ω ±200ppm°C 10Ω<R≤10MΩ ±100ppm°C 10MΩ<R≤22MΩ ±200ppm°C	Rated Current 2.0A Maximum Current 10.0A
SC2010	3/4W	-55°C to 155°C	200V	500V	500V	5% (E24) 1Ω≤R≤22MΩ 1% (E24/E96) 1Ω≤R≤10MΩ 0.1%,0.5% (E24/E96) 10Ω≤R≤1MΩ Jumper≤50mΩ	1Ω≤R≤10Ω ±200ppm°C 10Ω<R≤10MΩ ±100ppm°C 10MΩ<R≤22MΩ ±200ppm°C	Rated Current 2.0A Maximum Current 10.0A
SC2512	1W	-55°C to 155°C	200V	500V	500V	5% (E24) 1Ω≤R≤22MΩ 1% (E24/E96) 1Ω≤R≤10MΩ 0.1%,0.5% (E24/E96) 10Ω≤R≤1MΩ Jumper≤50mΩ	1Ω≤R≤10Ω ±200ppm°C 10Ω<R≤10MΩ ±100ppm°C 10MΩ<R≤22MΩ ±200ppm°C	Rated Current 2.0A Maximum Current 10.0A
	2W	-55°C to 155°C	200V	400V	500V	5% (E24) 1Ω≤R≤1MΩ 1% (E24/E96) 1Ω≤R≤1MΩ	1Ω≤R≤1MΩ ±200ppm°C	

5. FUNCTIONAL DESCRIPTION

FUNCTIONAL DESCRIPTION

OPERATING TEMPERATURE RANGE

SC0402 to SC2512 Range:-55°C to +155°C

(Fig.2)

SC0075 to SC0201 Range:-55°C to +125°C

(Fig.3)

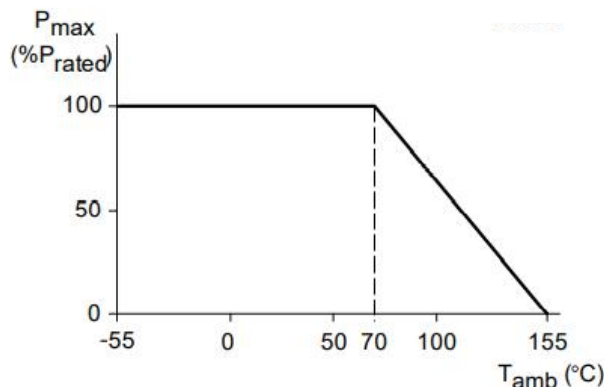

Fig2: Maximum dissipation (P) in percentage of rated power as a function of the operating ambient temperature

FUNCTIONAL DESCRIPTION

Each type rated power at 70 ±2°C:

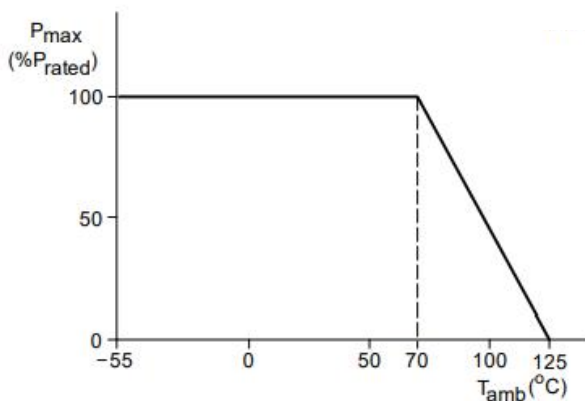

Fig3: Maximum dissipation (P) in percentage of rated power as a function of the operating ambient temperature

RATED VOLTAGE

The DC or AC (rms) continuous working voltage corresponding to the rated power is determined by the following formula:

$$V = (P \cdot R)^{1/2}$$

or max. working voltage whichever is less

Where

V=Continuous rated DC or AC

(rms)working voltage (V)

P= Rated power (W)

R = Resistance value (Ω)

6. FOOTPRINT AND SOLDERING PROFILES

FOOTPRINT DIMENSIONS



Fig4: Single resistor chips recommended dimensions of footprints

Table 3 Reflow soldering footprint dimensions for relevant chip resistors size ,see Fig 4.

Unit: mm					
PRODUCT SIZE CODE	FOOTPRINT DIMENSIONS				Placement accuracy
	A	B	C	D	
SC0075	0.34	0.14	0.10	0.15	N/A
SC0100	0.48	0.12	0.18	0.18~0.23	N/A
SC0201	1.00	0.30	0.35	0.40	N/A
SC0402	1.50	0.50	0.50	0.60	±0.15
SC0603	2.60	0.80	0.90	0.80	±0.25
SC0805	3.00	1.20	0.90	1.20	±0.25
SC1206	4.20	2.20	1.00	1.50	±0.25
SC1210	4.20	2.20	1.00	2.40	±0.25
SC2010	6.10	3.30	1.40	2.40	±0.25
SC2512	8.00	4.40	1.80	4.00	±0.25

Table 4 Wave soldering footprint dimensions for relevant chip resistors size ,see Fig 4.

Unit: mm					
PRODUCT SIZE CODE	FOOTPRINT DIMENSIONS				Placement accuracy
	A	B	C	D	
SC0603	2.70	0.90	0.90	0.80	±0.25
SC0805	3.30	1.30	1.00	1.30	±0.25
SC1206	4.70	2.50	1.10	1.70	±0.25
SC1210	4.70	2.50	1.10	2.50	±0.25
SC2010	6.40	4.20	1.10	2.50	±0.25
SC2512	8.20	5.50	1.35	3.20	±0.25

MOUNTING

Due to their rectangular shape and small dimensional tolerances, Surface Mounted Resistors are suitable for handling by automatic placement systems. Chip placement can be on ceramic substrates and printed-circuit boards (PCBs). Electrical connection to the circuit is by wave, vapour phase or infrared soldering. The end terminations guarantee a reliable contact and the protective coating enables 'face down' mounting.

The laws of heat conduction, convection and radiation determine the temperature rise in a resistor owing to power dissipation. The maximum body temperature usually occurs in the middle of the resistor and is called the hot-spot temperature. The hot-spot temperature depends on the ambient temperature and the dissipated power. This is described in the data sheet under the chapter heading "Functional description".

The hot-spot temperature is important for mounting because the connections to the chip resistors will reach a temperature close to the hot-spot temperature. Heat conducted by the connections must not reach the melting point of the solder at the

junctions. Therefore a maximum solder joint temperature of 110°C is advised.

The ambient temperature on large or very dense printed-circuit boards (PCBs) is influenced by the dissipated power. The ambient temperature will again influence the hot-spot temperature. Therefore, the packing density that is allowed on the PCB is influenced by the dissipated power.

EXAMPLE OF MOUNTING EFFECTS

Assume that the maximum temperature of a PCB is 95°C and the ambient temperature is 50°C. In this case the maximum temperature rise that may be allowed is 45°C.

In the graph (see Fig.5), this point is found by drawing the line from point A (PCB = 95°C) to point B (T_{amb} = 50°C) and from here to the left axis.

To find the maximum packing density, this horizontal line is extended until it intersects with the curve 0.125 W (point C). The maximum packing density, 19 units/50 × 50 mm² (point D), is found on the horizontal axis.

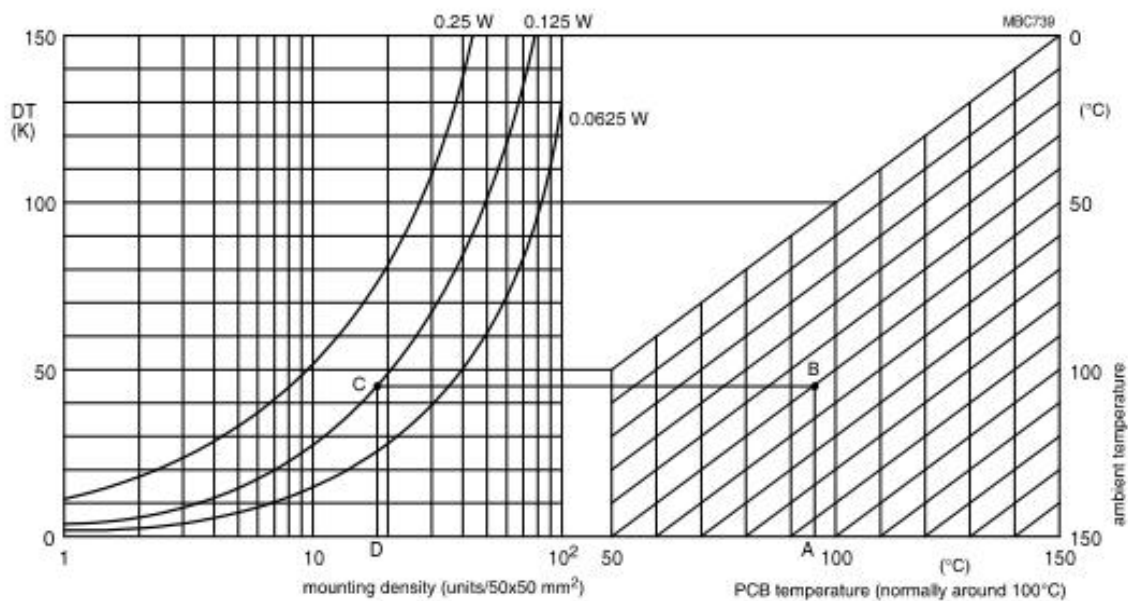

Fig5: PCB temperature as a function of applied power, mounting density ambient temperature

SOLDERING CONDITIONS

The lead free Surface Mount Resistors are able to stand the reflow soldering conditions as below:

- Temperature: above 220 °C
- Endurance: 95 to 120 seconds
- Cycles: 3 times The test of "soldering heat resistance" is carried out in

accordance with the schedule of "MIL-STD-202G-method 210F", "The robust construction of chip resistors allows them to be completely immersed in a solder bath of 260 °C for 10 seconds". Therefore, it is possible to mount Surface Mount Resistors on one side of a PCB and other discrete components on the reverse (mixed PCBs).

Surface Mount Resistors are tested for solder ability at 245 °C during 2 seconds. The test condition for no leaching is 260 °C for 30 seconds. Typical examples of soldering processes that provide reliable joints without any damage, the recommended soldering profiles referring to "IEC 61760-1" are given in Figs 6, 7 and 8.

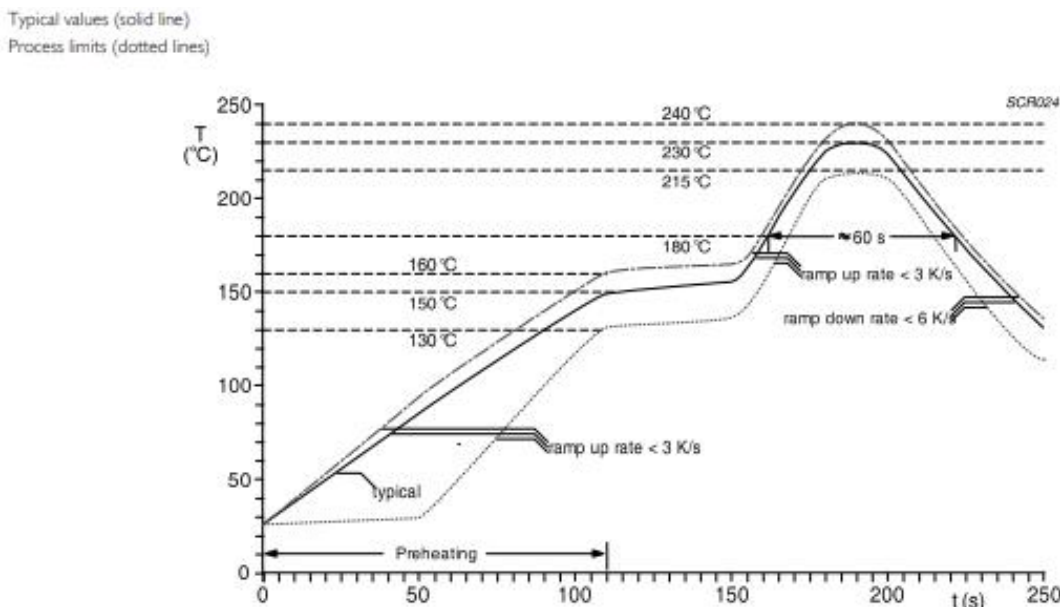

Fig6: Infrared soldering forced air convection reflow soldering-temperature/time profile for SnPb solders

SOLDERING CONDITION

Typical values (solid line)
Process limits (dotted lines)



Fig7: Infrared soldering forced air convection reflow soldering-temperature/time profile for **SnAgCu** solders

Typical values (solid line)
Process limits (dotted lines)

The resistors may be soldered twice in accordance with this method if desired



Fig8: Double wave soldering for SnPb and leadfree SnAgCu solder-temperature/time profile (terminal temperature)

7. PACKING STYLE & PACKAGING QUANTITY

PACKING STYLE AND PACKAGING QUANTITY

Table 3 Packing style and packaging quantity

PACKING STYLE	PAPER TAPING REEL(R)				
	EMBOSSSED TAPING REEL				
ESD SAFE REEL(S) 4MM WIDTH,1MM PITCH PLASTIC EMBOSSSED					
REEL DIMENSION	7"(178mm)	10"(254mm)	13"(330mm)	7"(178mm)	7"(178mm)
SC0075	---	---	---	20000	---
SC0100	20000	---	80000	40000	---
SC0201	10000	20000	50000	---	---
SC0402	10000	20000	50000	---	---
SC0603	5000	10000	20000	---	---
SC0805	5000	10000	20000	---	---
SC1206	5000	10000	20000	---	---
SC1210	5000	10000	20000	---	---
SC2010	---	---	---	---	4000
SC2512	---	---	---	---	4000

NOTE

For tape and reel specification / dimensions ,please refer to data sheet "Chip resistors packing" .

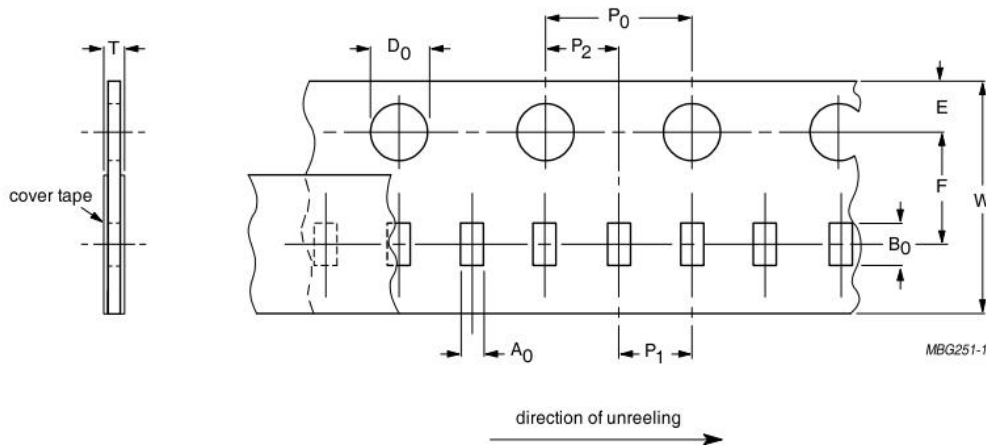

Fig9: Paper/PE tape

Table 5 Dimensions of paper/PE tape for relevant chip resistors size; see Fig.9

PRODUCT SIZE	SYMBOL										Unit: mm
CODE	A0	B0	W	E	F	P0	P1	P2	Ø D0	T	
SC0075	0.18± 0.03	0.33± 0.03	4.0± 0.05	0.90± 0.03	1.88± 0.02	2.0± 0.04	1.0± 0.02	1.0± 0.02	0.8± 0.04	0.20± 0.03	
SC0100	0.25± 0.05	0.45± 0.05	8.0± 0.02	1.75± 0.10	3.50± 0.05	4.0± 0.10	2.0± 0.05	2.0± 0.05	1.5+0.1/-0	0.31± 0.03	
SC0201	0.40± 0.05	0.70± 0.05	8.0± 0.02	1.75± 0.10	3.50± 0.05	4.0± 0.10	2.0± 0.05	2.0± 0.05	1.5+0.1/-0	0.42± 0.03	
SC0402	0.67± 0.03	1.17± 0.03	8.0± 0.10	1.75± 0.10	3.50± 0.05	4.0± 0.10	2.0± 0.05	2.0± 0.05	1.5+0.1/-0	0.42± 0.05	
SC0603	1.09± 0.05	1.86± 0.05	8.0± 0.10	1.75± 0.10	3.50± 0.05	4.0± 0.10	4.0± 0.05	2.0± 0.05	1.5+0.1/-0	0.60± 0.03	
SC0805	1.64± 0.05	2.37± 0.05	8.0± 0.10	1.75± 0.10	3.50± 0.05	4.0± 0.10	4.0± 0.05	2.0± 0.05	1.5+0.1/-0	0.75± 0.05	
SC1206	1.89± 0.05	3.37± 0.05	8.0± 0.10	1.75± 0.10	3.50± 0.05	4.0± 0.10	4.0± 0.05	2.0± 0.05	1.5+0.1/-0	0.75± 0.05	
SC1210	2.85± 0.10	3.50± 0.05	8.0± 0.10	1.75± 0.10	3.50± 0.05	4.0± 0.10	4.0± 0.05	2.0± 0.05	1.5+0.1/-0	0.75± 0.05	

NOTE

1. For size 0201, the typical value of thickness (excluding cover tape) is 0.42 mm for paper tape and 0.33 mm for PE tape.
2. M is reversed type.
3. For size 1206, the typical value of thickness (excluding cover tape) is 0.75±0.1.

TESTS AND REQUIREMENTS

ENVIRONMENTAL CONSIDERATIONS

- Cover tape, carrier tape and reel do not contain environmentally harmful PVC materials.
- Cover tape and reel are antistatic.
- Because the carrier tape is made of polycarbonate, a homogeneous material (mono-plastic), it is ideally suited for recycling
- Compared to other PVC-free materials polycarbonate shows excellent stiffness and very little deformation with temperature.

EMBOSSED/BLISTER TAPE

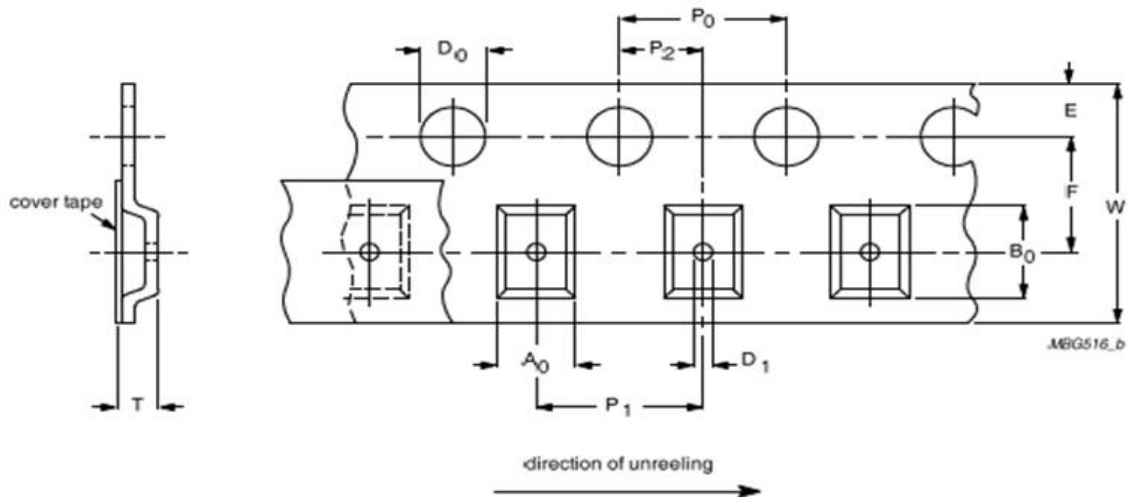

Fig10: Embossed/blister tape

PRODUCT SIZE	SYMBOL										Unit: mm
CODE	A0	B0	W	E	F	P0	P1	P2	$\varnothing D0$	T	
SC2010	2.77 ± 0.10	5.45 ± 0.10	12.0 ± 0.20	1.75 ± 0.10	5.50 ± 0.05	4.0 ± 0.10	4.0 ± 0.10	2.0 ± 0.05	$1.5 + 0.1 / - 0$	1.10 ± 0.10	
SC2512	3.40 ± 0.10	6.37 ± 0.10	12.0 ± 0.20	1.75 ± 0.10	5.50 ± 0.05	4.0 ± 0.10	4.0 ± 0.10	2.0 ± 0.05	$1.5 + 0.1 / - 0$	1.10 ± 0.10	

LEADER/TRAILER TAPE SPECIFICATION

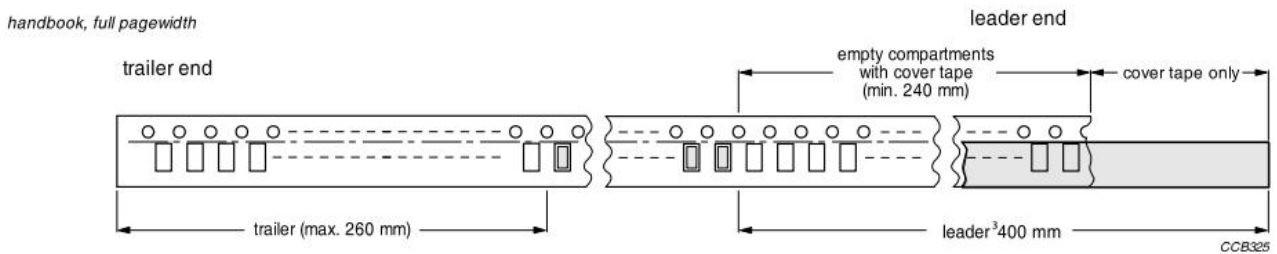

Fig11: Leader/trailer tape

TAPING REQUIREMENTS

- Resistance side faces up.
- Component is free and not sticking to top and/or bottom tape.
- Component should be easy to remove from carrier tape and the chip cavity should have no mechanical damage

PEEL-OFF FORCE

- Peel-off forces of both paper/PE and embossed/blister tapes are in accordance with "IEC 60286-3" ; that is, at a peel-off speed of 300 ± 10 mm/minute, 0.1 N to 1.0 N for 8 mm tape and 0.1 N to 1.3 N for tape larger than 8 mm. The peel-off angle should be between 165° and 180° .



handbook, full pagewidth



Fig12: Peel-off force

REEL SPECIFICATION



Fig13: Reel

PRODUCT SIZE	QUANTITY	REEL SIZE		Unit: mm					
		8 mm tape width	12 mm tape width	A	N	C	D	W1	W2max.
SC0075	20,000	---	---	---	---	---	---	---	---
	20,000	7" (Ø 178 mm)	---	180 +0/-3	60 +1/-0	13.0 ± 0.2	---	9.0 ± 0.2	12.0 ± 0.2
SC0100	40,000	---	---	---	---	---	---	---	---
	80,000	13" (Ø 330 mm)	---	330 +0/-3	100 ± 0.5	13.5 ± 0.5	---	10.0 ± 0.5	14.0 ± 0.5
	10,000	---	---	---	---	---	---	---	---
SC0201	15,000	7" (Ø 178 mm)	---	180 +0/-3	60 +1/-0	13.0 ± 0.2	---	9.0 ± 0.2	12.0 ± 0.2
	20,000	---	---	---	---	---	---	---	---
	50,000	13" (Ø 330 mm)	---	330 +0/-3	100 ± 0.5	13.5 ± 0.5	---	10.0 ± 0.5	14.0 ± 0.5
	10,000	---	---	---	---	---	---	---	---
SC0402	20,000	7" (Ø 178 mm)	---	180 +0/-3	60 +1/-0	13.0 ± 0.2	21.0 ± 0.8	9.0 ± 0.2	12.0 ± 0.2
	20,000	10" (Ø 254 mm)	---	254 +0/-3	100 ± 0.5	13.0 ± 0.2	---	9.8 ± 0.5	13.0 ± 0.5
	50,000	13" (Ø 330 mm)	---	330 +0/-3	100 ± 0.5	13.5 ± 0.5	---	10.0 ± 0.5	14.0 ± 0.5
SC0603/SC0805/	5,000	7" (Ø 178 mm)	---	180 +0/-3	60 +1/-0	13.0 ± 0.2	---	9.0 ± 0.2	12.0 ± 0.2
	10,000	10" (Ø 254 mm)	---	254 +0/-3	100 ± 0.5	13.0 ± 0.2	---	9.8 ± 0.5	13.0 ± 0.5
SC1206	20,000	13" (Ø 330 mm)	---	330 +0/-3	100 ± 0.5	13.5 ± 0.5	---	10.0 ± 0.5	14.0 ± 0.5
	5,000	7" (Ø 178 mm)	---	180 +0/-3	60 +1/-0	13.0 ± 0.2	---	9.0 ± 0.2	12.0 ± 0.2
SC1210	20,000	13" (Ø 330 mm)	---	330 +0/-3	100 ± 0.5	13.5 ± 0.5	---	10.0 ± 0.5	14.0 ± 0.5
SC2010	4,000	---	7" (Ø 178 mm)	180 +0/-3	60 +1/-0	13.0 ± 0.2	---	13.6 ± 0.5	16.5 ± 0.5
SC2512	4,000	---	7" (Ø 178 mm)	180 +0/-3	60 +1/-0	13.0 ± 0.2	---	13.6 ± 0.5	16.5 ± 0.5

TAPE AND REEL SPECIFICATIONS

All tape and reel specifications are in accordance with "IEC 60286-3". Basic dimensions are given in Figs 1, 2 and 5, and Tables 1, 2 and 3.

PAPER/PE TAPE

ADVANTAGE - PE TAP

- Better anti-moisture
- Less fiber
- Meet "ISO 14000" environmental regulation

MATERIAL CHARACTERISTIC - PE TAPE

- PE is a polymer material commonly used for food containers, plastic bags and toys, so is safe for human beings. In addition, it is recyclable.
- Conform to "ISO14000" environmental packing and American F.D.A restraint regulations

8. TESTS AND REQUIREMENTS

TESTS AND REQUIREMENTS

TEST	TEST METHOD	PROCEDURE	REQUIREMENTS
Temperature Coefficient of Resistance (T.C.R.)	MIL-STD-202 Method 304	At +25/-55°C and +25/+125°C Formula: $T.C.R = \frac{R2 - R1}{R1 \times (t2 - t1)} \times 10^6 \text{ (ppm/C)}$ Where t1=+25 °C or specified room temperature t2=-55 °C or +125 °C test temperature R1=resistance at reference temperature in ohms R2=resistance at test temperature in ohms	Refer to table 2
Life/ Endurance	MIL-STD-202 Method 108A IEC 60115-1 4.25.1	At 70± 2°C for 1,000 hours; RCWV applied for 1.5 hours on and 0.5 hour off, s till air required	0075: ± (5%+100mΩ) <100mΩ for jumper 0100: ±(3% +50mΩ) <100mΩf or jumper Others: ± (1%+50mΩ) for B/D/F tol ± (3%+50mΩ) for J tol <100mR for jumper
High Temperature Exposure	MIL-STD-202 Method 108A IEC 60068-2-2	1,000 hours at maximum operating temperature depending on specification, unpowered.	0075: ± (5%+100mΩ) <100mΩ for jumper 0100: ±(1% +50mΩ) < 50mΩf or jumper Others: ± (1%+50mΩ) for B/D/F tol ± (2%+50mΩ) for J tol <50mR for jumper
Moisture Resistance	MIL-STD-202 Method 106G	Each temperature / humidity cycle is defined at 8 hours (method 106F), 3 cycles / 24 hours for 10d with 25°C / 65°C 95% R.H, without steps 7a&7b, unpowered Parts mounted on test-boards, without condensation on parts	0075: ± (2%+100mΩ) <100mΩ for jumper 0100: ±(2% +50mΩ) < 100mΩf or jumper Others: ± (0.5%+50mΩ) for B/ D/F tol ± (2%+50mΩ) for J tol <100mR for jumper
Humidity	IEC 60115-1 4.24.2	Steady state for 1000 hours at 40°C / 95% R.H. RCWV applied for 1.5 hours on and 0.5 hour off	0075: ± (5%+100mΩ) no visible damage 0100: ±(3% +50mΩ) < 100mΩf or jumper Others: ± (1%+50mΩ) for B/D/F tol ± (2%+50mΩ) for J tol <100mR for jumper
Thermal Shock	MIL-STD-202 Method 107G	-55/+125°C Note Number of cycles required is 300. Devices mounted Maximum transfer time is 20 seconds. Dwell time is 15 minutes. Air - Air	0075/0100: ± (1% +50mΩ) < 50mΩf or jumper Others: ± (0.5%+50mΩ) for B/D/F tol ± (1%+50mΩ) for J tol < 50mR for jumper

TESTS AND REQUIREMENTS

TEST	TEST METHOD	PROCEDURE	REQUIREMENTS
Short Time Overload	IEC 60115-1 4.13	2.5 times RCWV or maximum overload voltage which is less for 5 seconds at room temperature	0075/0100: $\pm (2\% + 50m\Omega)$ < 50m Ω f or jumper Others: $\pm (1\% + 50m\Omega)$ for B/D/F tol $\pm (2\% + 50m\Omega)$ for J tol <50mR for jumper No visible damage
Board Flex/Bending	IEC 60115-1 4.33	Device mounted or as described only 1 board bending required bending time: 60 \pm 5 seconds 0075/0100/0201/0402:5mm; 0603/0805:3mm; 1206 and above:2mm	0075/0100: $\pm (1\% + 50m\Omega)$ < 50m Ω f or jumper Others: $\pm (1\% + 50m\Omega)$ for B/D/F/J tol <50mR for jumper No visible damage
Solderability - Wetting	J-STD-002 test B	Electrical Test not required Magnification 50X SMD conditions: 1st step: method B, aging 4 hours at 155°C dry heat 2nd step: leadfree solder bath at 245 \pm 3°C Dipping time: 3 \pm 0.5 seconds	Well tinned (>95% covered) No visible damage
-Leaching	J-STD-002 test D	Leadfree solder ,260°C, 30 seconds immersion time	No visible damage
-Resistance to Soldering Heat	MIL-STD-202 Method 210F IEC 60115-1 4.18	Condition B, no pre-heat of samples Leadfree solder, 260°C \pm 5°C, 10 \pm 1 seconds immersion time Procedure 2 for SMD: devices fluxed And cleaned with isopropanol	0075: $\pm (3\% + 50m\Omega)$ <50m Ω for jumper 0100: $\pm (1\% + 50m\Omega)$ < 50m Ω f or jumper Others: $\pm (0.5\% + 50m\Omega)$ for B/D/F tol. $\pm (1\% + 50m\Omega)$ for J tol. <50mR for jumper No visible damage

9. REVISION HISTORY

REVISION HISTORY

REVISION	DATE	CHANGE NOTIFICATION	DESCRIPTIONN
Version 1	24-03-2022	-	-First issue of this specification

10. SUNWAY CONTACT

Asia

HQ Shenzhen China

No. 1013, Xihuan Road, Shajing Town,
Bao'an District, Shenzhen, China
Tel:+86-755-81773388
E-mail:Sales-south@sz-sunway.com

Shenzhen China

North third floor, block A, Tefa
information port, No. 2 Kefeng Road,
Science Park, Nanshan District,
Shenzhen,China
E-mail:Sales-south@sz-sunway.com

Beijing china

No.14, Jinxiu Street, Business
Development Area, Beijing, China
E-mail:Sales-east@sz-sunway.com

Shanghai China

Floor 1, Building 1, No. 2653 Hunan
Road, Pudong New Area, Shanghai,
China
E-mail:Sales-east@sz-sunway.com

Changzhou China

No.369 Jinlong Road, Jintan District,
Changzhou, China
E-mail:Sales-east@sz-sunway.com

Yiyang China

Yiyang High-tech Zone East Industrial
Park Standardized Plant, Yiyang,China
E-mail:Sales-east@sz-sunway.com

Mianyang china

No.268 Binhe North Road West Section,
High-tech Zone, Mianyang, China

Taiwan China

Floor 2, NO 637 Ruiguang Road, Neihu
District, Taipei City 114, Taiwan

Shin-Yokohama Japan

3rd floor-A, INTELLEX-Shin-Yokohama
building 1-17-12, Shin-yokohama,
Kohoku-ku, Yokohama-shi, Kanagawa,
Janpan

Suwon South Korea

101-801, Digital Empire 2,#88
Sinwon-road,Yeongtong-gu,Suwon-Si,
Gyeonggi-do, Korea

Vinh Phuc Vietnam

CNO8-2, Binh Xuyen 2 IP, Ba Hien, Binh
Xuyen,Vinh Phuc,Vietnam

Northern America

Cupertino USA

20040 Stevens Creek Blvd, Suite 100,
Cupertino, CA95014,USA

San Diego USA

10180Telesis Ct Suite165/220,San
Diego, CA 92121,USA

Europe

Stockholm Sweden

Kistagangen 20BS-164 40 Kista, Sweden
Email:europe@sz-sunway.com

Bettlach Switzerland

Bischmattstrasse 7 CH-2544 Bettlach,
Switzerland
Email:europe@sz-sunway.com

X-ON Electronics

Largest Supplier of Electrical and Electronic Components

Click to view similar products for [Thick Film Resistors - SMD category](#):

Click to view products by [Sunway manufacturer](#):

Other Similar products are found below :

[CR-05FL7--150R](#) [CR-05FL7--19K6](#) [CR-05FL7--243R](#) [CR-05FL7--40K2](#) [CR-05FL7--698K](#) [CR-12FP4--324R](#) [CR-12JP4--680R](#)
[M55342K06B1E78RS3](#) [M55342K06B6E19RWL](#) [M55342K06B6E81RS3](#) [M55342M05B200DRWB](#) [M55342M06B4K70MS3](#) [MC0603-511-](#)
[JTW](#) [742C083750JTR](#) [MCR01MZPF1202](#) [MCR01MZPF1601](#) [MCR01MZPF1800](#) [MCR01MZPF6201](#) [MCR01MZPF9102](#) [MCR01MZPJ113](#)
[MCR01MZPJ121](#) [MCR01MZPJ125](#) [MCR01MZPJ751](#) [MCR03EZHJ103](#) [MCR03EZPFX2004](#) [MCR03EZPJ270](#) [MCR03EZPJ821](#)
[MCR10EZPF1102](#) [MCR18EZPJ330](#) [RC0603F1473CS](#) [RC0603F150CS](#) [RC1005F1152CS](#) [RC1005F1182CS](#) [RC1005F1372CS](#)
[RC1005F183CS](#) [RC1005F1911CS](#) [RC1005F1912CS](#) [RC1005F203CS](#) [RC1005F2052CS](#) [RC1005F241CS](#) [RC1005F2431CS](#)
[RC1005F3011CS](#) [RC1005F303CS](#) [RC1005F4321CS](#) [RC1005F4642CS](#) [RC1005F471CS](#) [RC1005F4751CS](#) [RC1005F5621CS](#)
[RC1005F6041CS](#) [RC1005J106CS](#)