

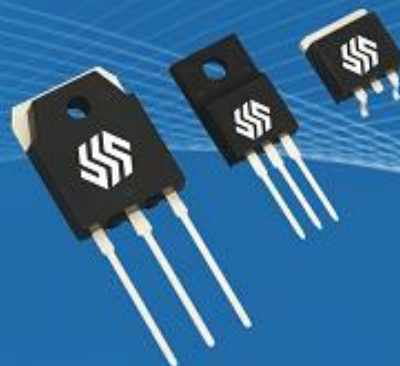

SUPER-SEMI



SUPER-MOSFET

Super Junction Metal Oxide Semiconductor Field Effect Transistor

650V Super Junction Power MOSFET Gen- II
SS*65R260S2

Rev. 1.1
Sep. 2019

www.supersemi.com.cn



SSF65R260S2/SSP65R260S2

650V N-Channel Super-Junction MOSFET Gen-II

Description

SJ-FET is new generation of high voltage MOSFET family that is utilizing an advanced charge balance mechanism for outstanding low on-resistance and lower gate charge performance. This advanced technology has been tailored to minimize conduction loss, provide superior switching performance, and withstand extreme dv/dt rate and higher avalanche energy. SJ-FET is suitable for various AC/DC power conversion in switching mode operation for higher efficiency.

Features

- Multi-Epi process SJ-FET
- 700V @T_J = 150 °C
- Typ. RDS(on) = 0.22Ω
- Ultra Low Gate Charge (typ. Q_g = 28nC)
- 100% avalanche tested

SSF65R260S2



SSP65R260S2

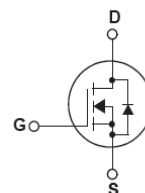

Absolute Maximum Ratings

Symbol	Parameter	SSP65R260S2	SSF65R260S2	Unit
V _{DSS}	Drain-Source Voltage	650		V
I _D	Drain Current -Continuous (TC = 25°C) -Continuous (TC = 100°C)	16* 10*		A
I _{DM}	Drain Current - Pulsed (Note 1)	60		A
V _{GSS}	Gate-Source voltage	±30		V
E _{AS}	Single Pulsed Avalanche Energy (Note 2)	235		mJ
I _{AS}	Avalanche current, repetitive or not-repetitive (pulse width limited by T _J max)	2.8		A
dv/dt	Peak Diode Recovery dv/dt (Note 3)	15		V/ns
dVds/dt	Drain Source voltage slope (V _{ds} =480V)	50		V/ns
P _D	Power Dissipation (TC = 25°C)	120	32	W
T _J , T _{STG}	Operating and Storage Temperature Range	-55 to +150		°C
T _L	Maximum Lead Temperature for Soldering Purpose, 1/16" from Case for 10 Seconds	260		°C

* Drain current limited by maximum junction temperature. Maximum duty cycle D=0.75

Thermal Characteristics

Symbol	Parameter	SSP65R260S2	SSF65R260S2	Unit
R _{θJC}	Thermal Resistance, Junction-to-Case	1	3.9	°C/W
R _{θCS}	Thermal Resistance, Case-to-Sink Typ.	0.5	-	°C/W
R _{θJA}	Thermal Resistance, Junction-to-Ambient	62	80	°C/W



Electrical Characteristics TC = 25°C unless otherwise noted

SSF65R260S2/SSP65R260S2 650V N-Channel Super-Junction MOSFET Gen-II

Symbol	Parameter	Conditions	Min	Typ	Max	Unit
Off Characteristics						
BV _{DSS}	Drain-Source Breakdown Voltage	V _{GS} = 0V, I _D = 250μA, T _J = 25°C	650	-	-	V
		V _{GS} = 0V, I _D = 250μA, T _J = 150°C	-	700	-	V
ΔBV _{DSS} /ΔT _J	Breakdown Voltage Temperature Coefficient	I _D = 250μA, Referenced to 25°C	-	0.6	-	V/°C
I _{DSS}	Zero Gate Voltage Drain Current	V _{DS} = 650V, V _{GS} = 0V -T _C = 125°C	-	-	1 100	μA μA
I _{GSSF}	Gate-Body Leakage Current, Forward	V _{GS} = 30V, V _{DS} = 0V	-	-	100	nA
I _{GSSR}	Gate-Body Leakage Current, Reverse	V _{GS} = -30V, V _{DS} = 0V	-	-	-100	nA
On Characteristics						
V _{GS(th)}	Gate Threshold Voltage	V _{DS} = V _{GS} , I _D = 250μA	2.0	3.0	4.0	V
R _{DS(on)}	Static Drain-Source On-Resistance	V _{GS} = 10V, I _D = 8A	-	0.22	0.26	Ω
Dynamic Characteristics						
C _{iss}	Input Capacitance	V _{DS} = 100V, V _{GS} = 0V, f = 1.0MHz	-	1050	-	pF
C _{oss}	Output Capacitance		-	37	-	pF
C _{rss}	Reverse Transfer Capacitance		-	1.1	-	pF
Q _g	Total Gate Charge	V _{DS} = 400V, I _D = 8A, V _{GS} = 10V (Note 4)	-	28	-	nC
Q _{gs}	Gate-Source Charge		-	6.2	-	nC
Q _{gd}	Gate-Drain Charge		-	9.8	-	nC
R _g	Gate resistance	f=1 MHz, open drain	-	13	-	Ω
Switching Characteristics						
t _{d(on)}	Turn-On Delay Time	V _{DS} = 400V, I _D = 8A R _G = 15Ω, V _{GS} = 12V (Note 4)	-	17	-	ns
t _r	Turn-On Rise Time		-	18	-	ns
t _{d(off)}	Turn-Off Delay Time		-	89	-	ns
t _f	Turn-Off Fall Time		-	20	-	ns
Drain-Source Diode Characteristics and Maximum Ratings						
I _S	Maximum Continuous Drain-Source Diode Forward Current		-	-	16	A
I _{SM}	Maximum Pulsed Drain-Source Diode Forward Current		-	-	60	A
V _{SD}	Drain-Source Diode Forward Voltage	V _{GS} = 0V, I _S = 16A	-	0.9	1.4	V
t _{rr}	Reverse Recovery Time	V _{GS} = 0V, V _{DS} = 400V, I _S = 8A, di _f /dt = 100A/μs	-	285	-	ns
Q _{rr}	Reverse Recovery Charge		-	3.1	-	μC
I _{rrm}	Peak Reverse Recovery Current		-	22	-	A

NOTES:

1. Repetitive Rating: Pulse width limited by maximum junction temperature
2. I_D = I_{AS}, V_{DD} = 50V, Starting T_J = 25 °C
3. I_{SD} ≤ I_D, di/dt ≤ 200A/μs, V_{DP} ≤ BV_{DSS}, Starting T_J = 25 °C
4. Essentially Independent of Operating Temperature Typical Characteristics



Typical Performance Characteristics

Safe operating area TC=25 °C
Non FullPAK

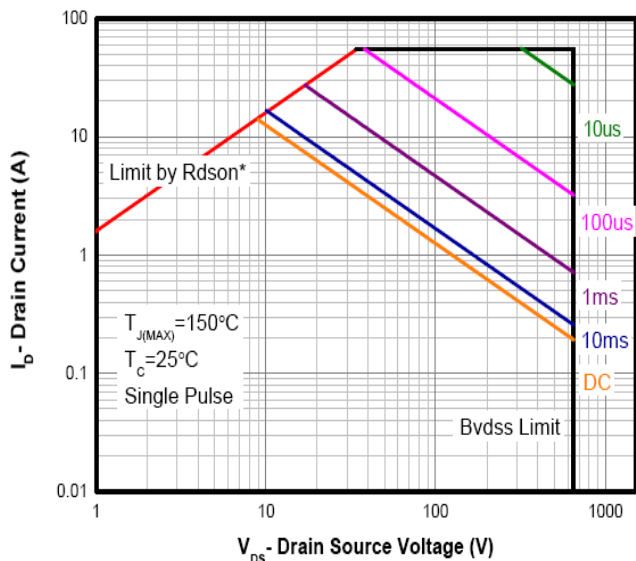

Safe operating area TC=25 °C
TO-220FullPAK

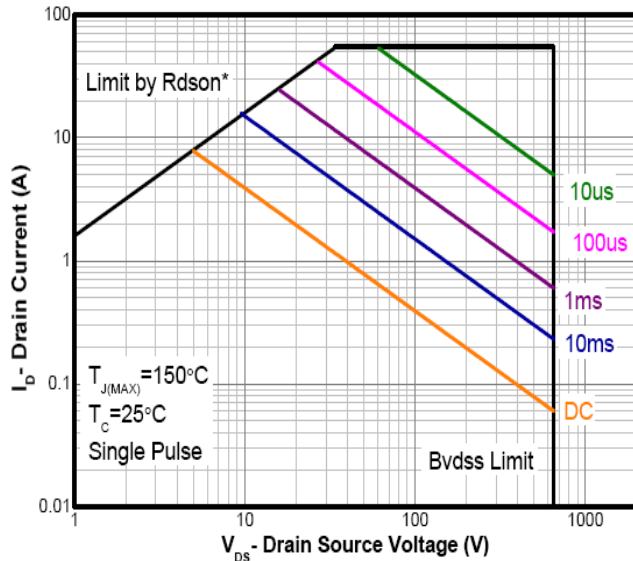

Typ. output characteristics $T_j=25\text{ }^{\circ}\text{C}$

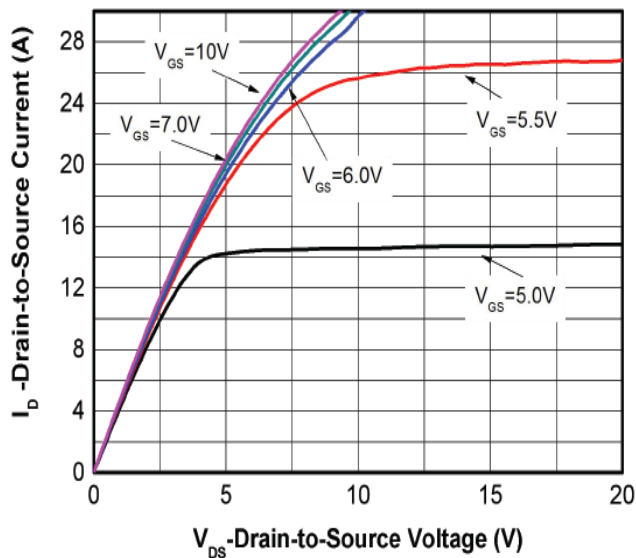

Typ. transfer characteristics

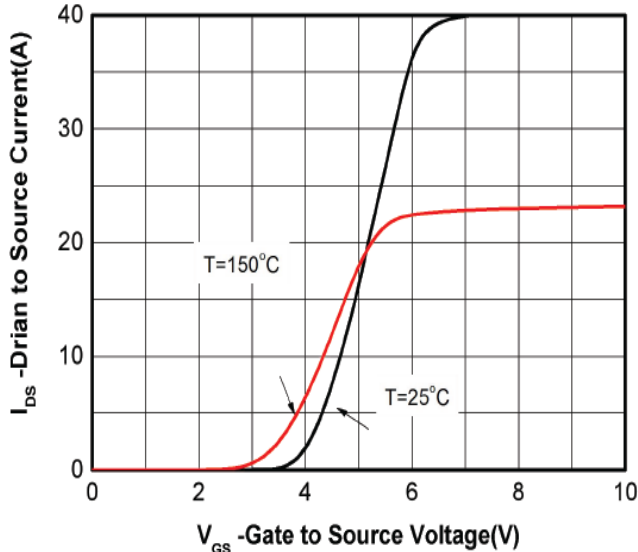

SSF65R260S2/SSP65R260S2 650V N-Channel Super-Junction MOSFET Gen-II



Typical Performance Characteristics

Typ. drain-source on-state resistance

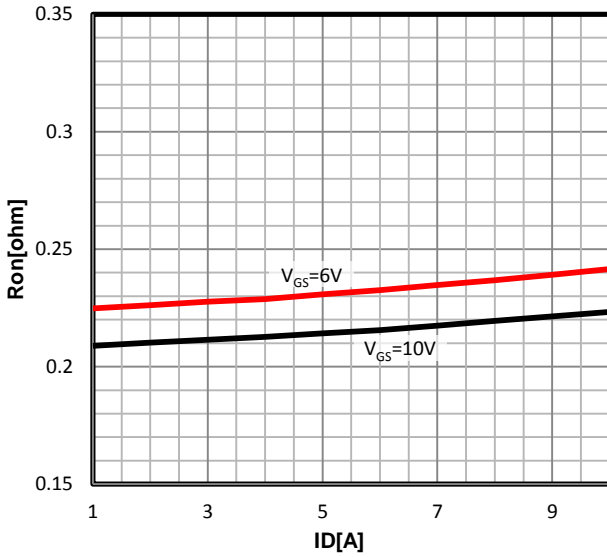

Normalized on resistance vs temperature

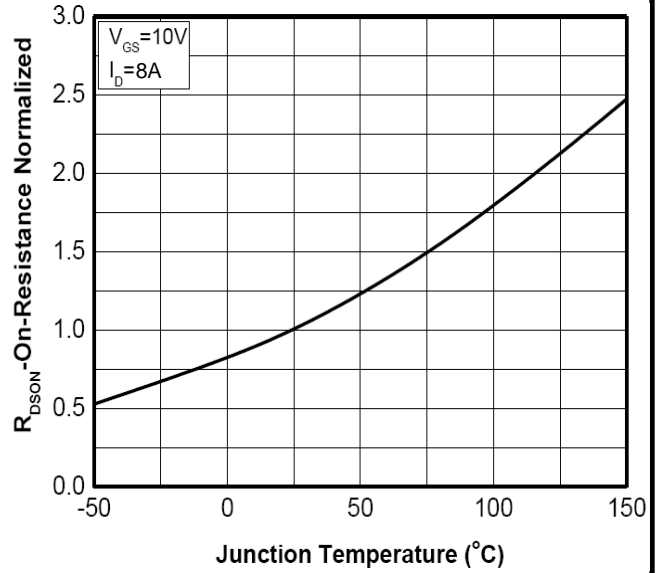

Typ. capacitances

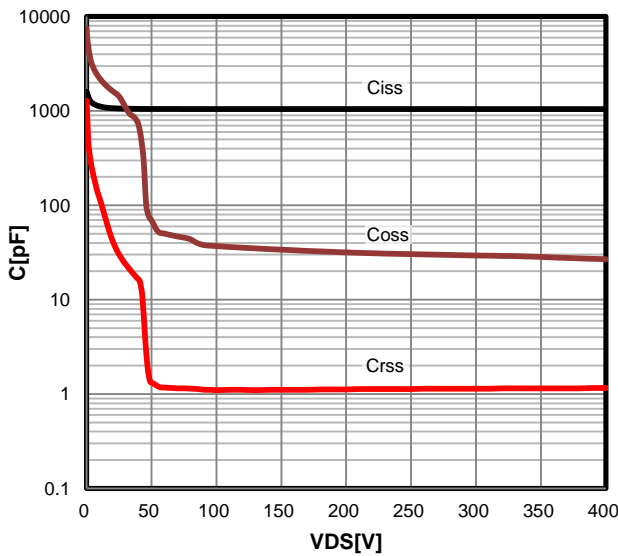

Typ. gate charge characteristics

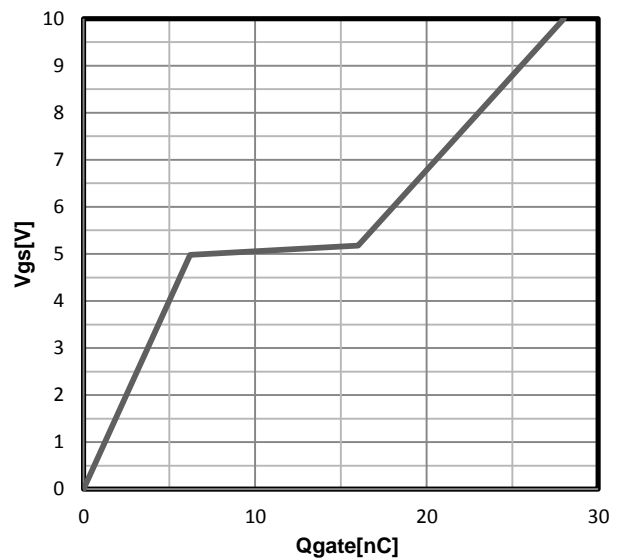



Typical Performance Characteristics

Power dissipation

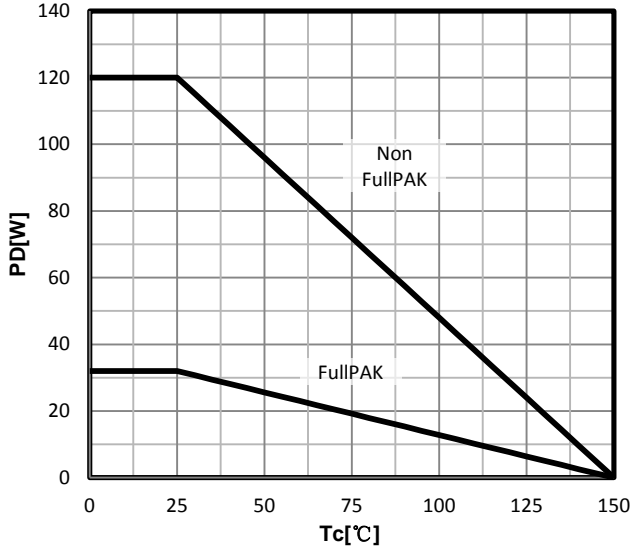

Forward characteristics of reverse diode

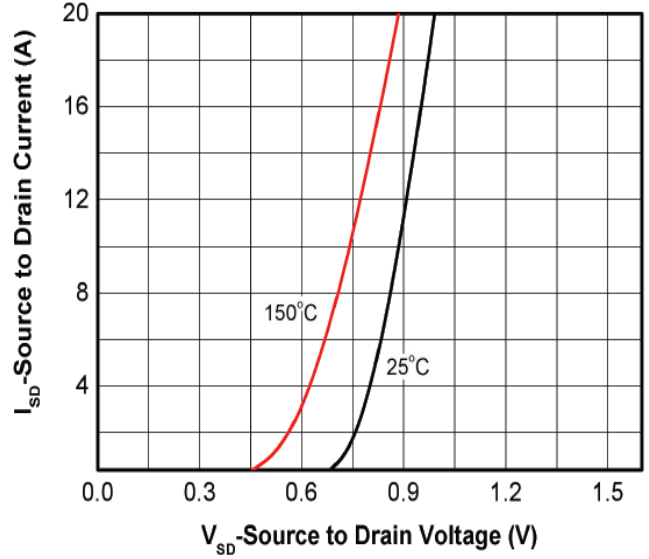

Drain-source breakdown voltage

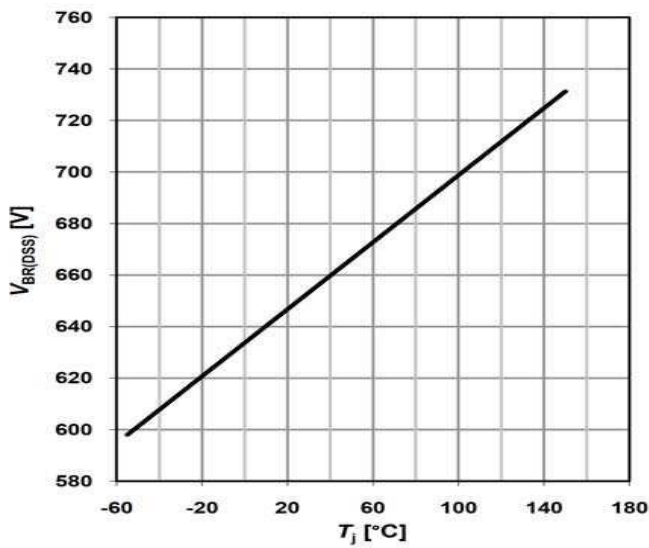

Normalized VGS(th) characteristics

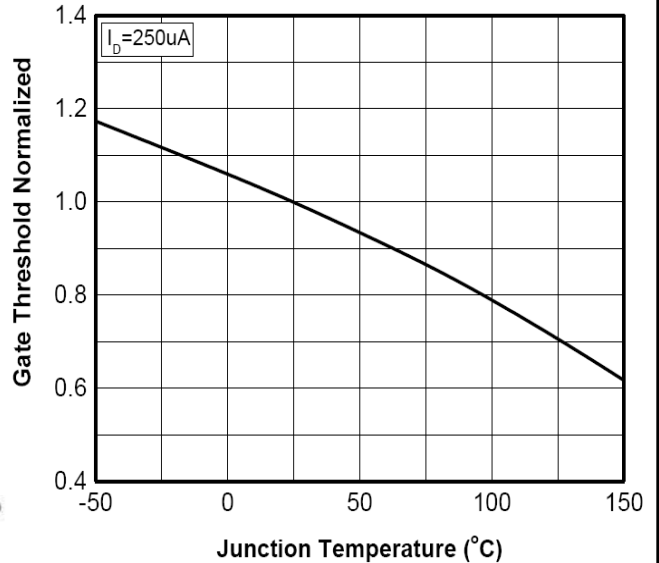



Typical Performance Characteristics

Max. transient thermal impedance Non FullPAK

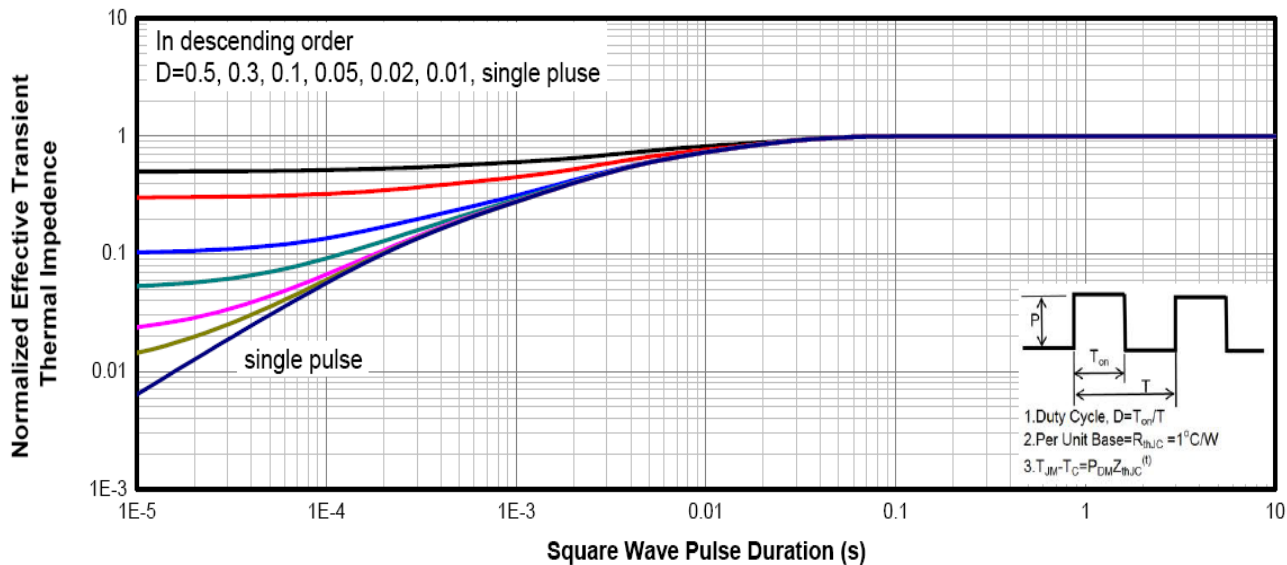

Max. transient thermal impedance TO-220FullPAK

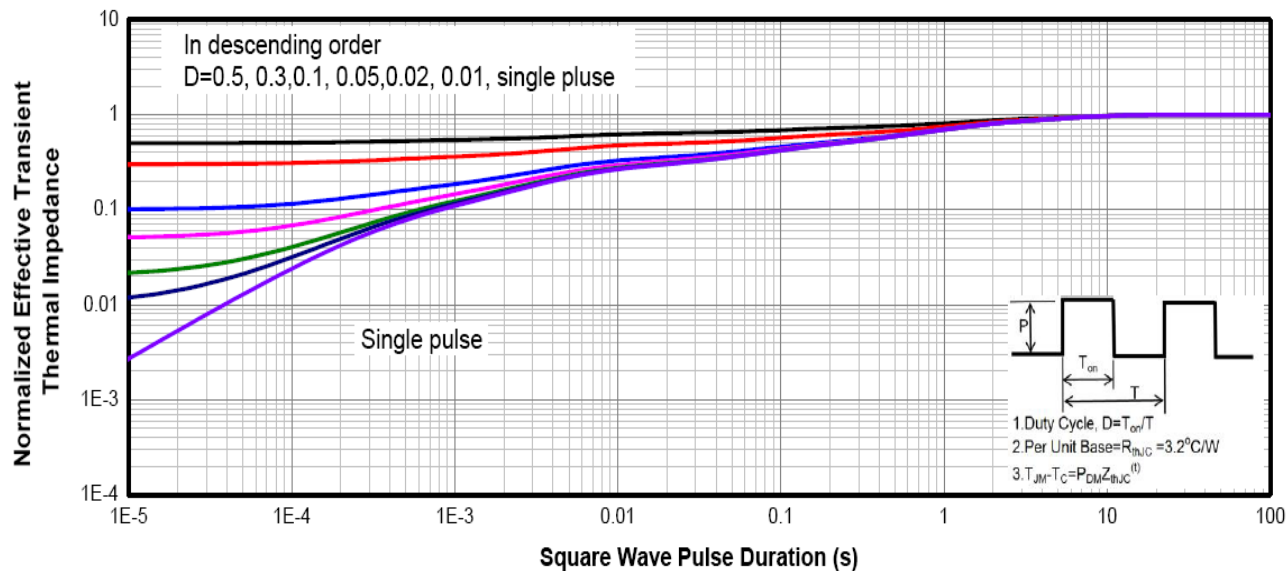

Switching times test circuit and waveform for inductive load

Switching times test circuit for inductive load

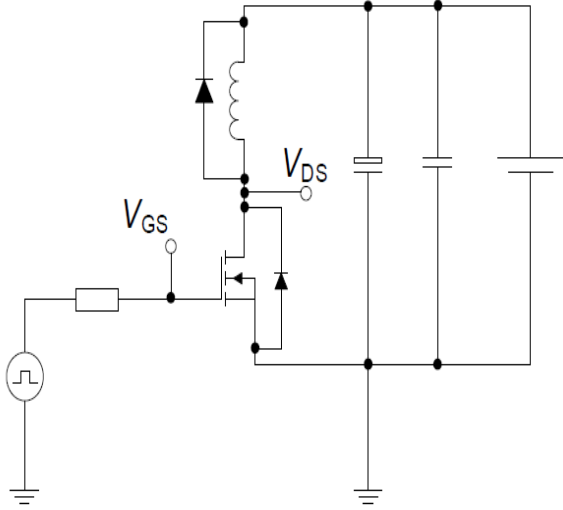

Switching time waveform

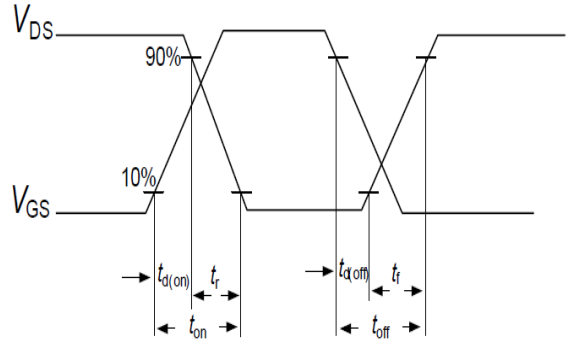

Unclamped inductive load test circuit and waveform

Unclamped inductive load test circuit

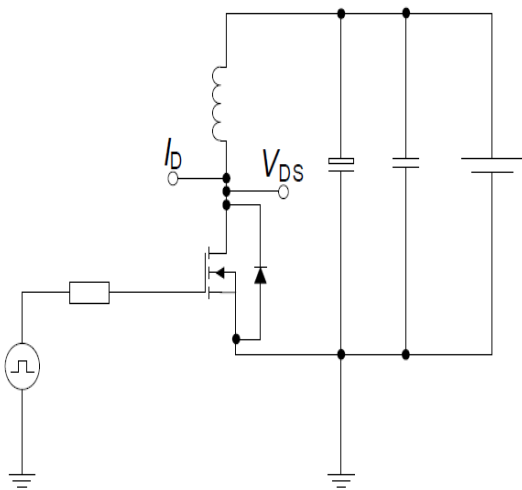

Unclamped inductive waveform

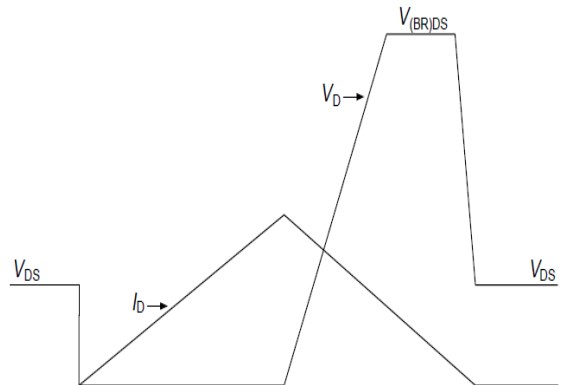

Test circuit and waveform for diode characteristics

Test circuit for diode characteristics

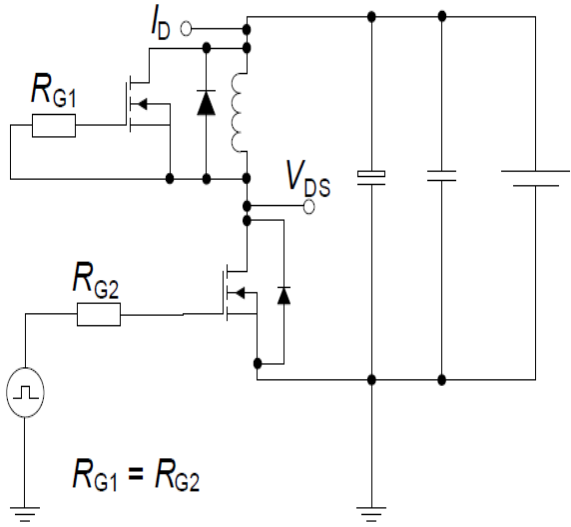

Diode recovery waveform

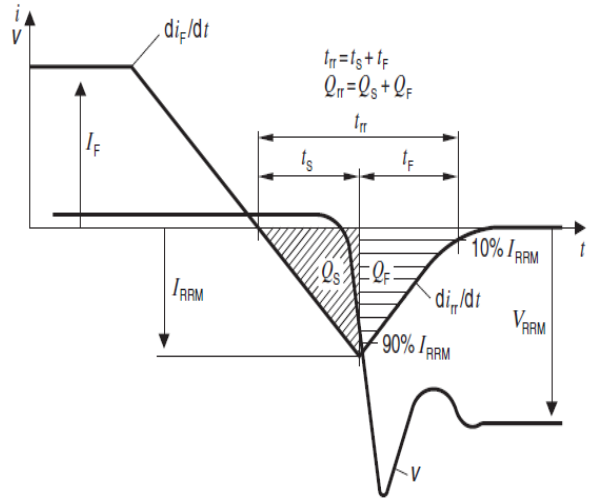

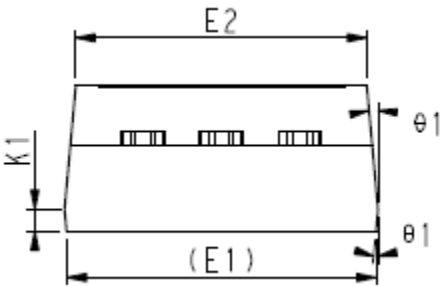
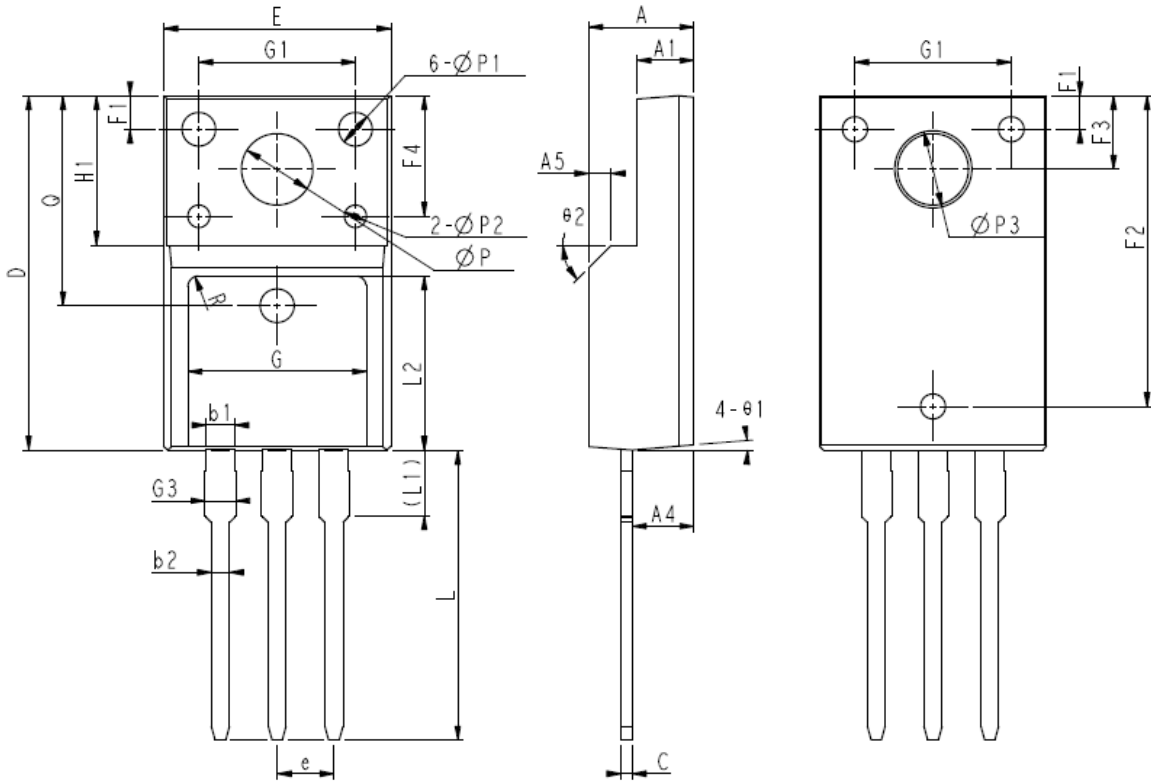

COMMON DIMENSIONS

SYMBOL	MM		
	MIN	NOM	MAX
E	10.00	10.16	10.32
E1	9.94	10.04	10.14
E2	9.36	9.46	9.56
A	4.50	4.70	4.90
A1	2.34	2.54	2.74
A4	2.66	2.76	2.86
A5	1.00REF		
c	0.45	0.50	0.60
D	15.67	15.87	16.07
Q	9.40REF		
H1	6.70REF		
e	2.54BSC		
Φ P	3.18REF		
L	12.78	12.98	13.18
L1	2.83	2.93	3.03
L2	7.70	7.80	7.90
Φ P1	1.40	1.50	1.60
Φ P2	0.95	1.00	1.05
Φ P3	3.45REF		
θ 1	3°	5°	7°
θ 2	-	45°	-
F1	1.00	1.50	2.00
F2	13.80	13.90	14.00
F3	3.20	3.30	3.40
F4	5.30	5.40	5.50
G	7.80	8.00	8.20
G1	6.90	7.00	7.10
G3	1.25	1.35	1.45
b1	1.23	1.28	1.38
b2	0.75	0.80	0.90
K1	0.65	0.70	0.75
R	0.50REF		

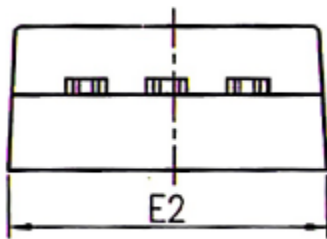
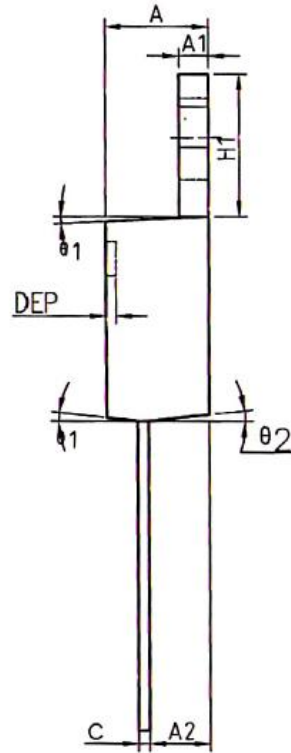
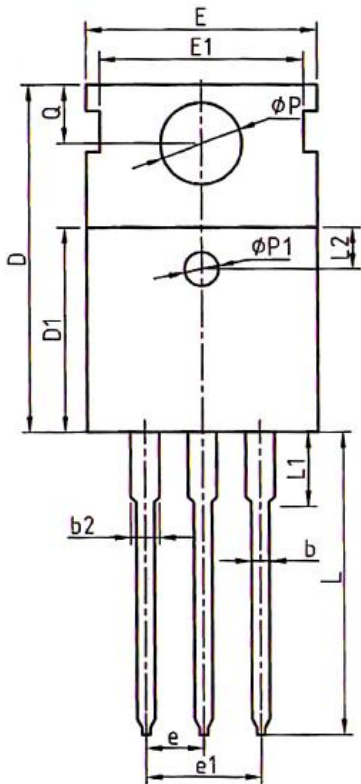

COMMON DIMENSIONS

SYMBOL	MM		
	MIN	NDM	MAX
A	4.40	4.57	4.70
A1	1.27	1.30	1.37
A2	2.35	2.40	2.50
b	0.77	0.80	0.90
b2	1.17	1.27	1.36
c	0.48	0.50	0.56
D	15.40	15.60	15.80
D1	9.00	9.10	9.20
DEP	0.05	0.10	0.20
E	9.80	10.00	10.20
E1	-	8.70	-
E2	9.80	10.00	10.20
$\phi P1$	1.40	1.50	1.60
e	2.54BSC		
e1	5.08BSC		
H1	6.40	6.50	6.60
L	12.75	13.50	13.65
L1	-	3.10	3.30
L2	2.50REF		
ϕP	3.50	3.60	3.63
Q	2.73	2.80	2.87
$\theta 1$	5°	7°	9°
$\theta 2$	1°	3°	5°
$\theta 3$	1°	3°	5°



DISCLAIMER

SUPER SEMICONDUCTOR reserves the right to make changes WITHOUT further notice to any products herein to improve reliability, function, or design.

For documents and material available from this datasheet, SUPER SEMICONDUCTOR does not warrant or assume any legal liability or responsibility for the accuracy, completeness of any product or technology disclosed hereunder.

The information given in this document shall in no event be regarded as a guarantee of conditions or characteristics. With respect to any examples or hints given herein, any typical values stated herein and/or any information regarding the application of the device, SUPER SEMICONDUCTOR hereby disclaims any and all warranties and liabilities of any kind, including without limitation, warranties of non-infringement of intellectual property rights of any third party.

The products shown herein are not designed for use as critical components in medical, life-saving, or life-sustaining applications, whose failure to perform can be reasonably expected to cause the failure of the life support device or system, or to affect its safety or effectiveness. Customers using or selling SUPER SEMICONDUCTOR products not expressly indicated for use in such applications do so entirely at their own risk and agree to fully indemnify SUPER SEMICONDUCTOR for any damages arising or resulting from such use or sale.

INFORMATION

For further information on technology, delivery terms and conditions and prices, please contact SUPER SEMICONDUCTOR office or website (www.supersemi.com.cn).

X-ON Electronics

Largest Supplier of Electrical and Electronic Components

Click to view similar products for [MOSFET](#) category:

Click to view products by [Super Semiconductor](#) manufacturer:

Other Similar products are found below :

[614233C](#) [648584F](#) [MCH3443-TL-E](#) [MCH6422-TL-E](#) [FDPF9N50NZ](#) [FW216A-TL-2W](#) [FW231A-TL-E](#) [APT5010JVR](#) [NTNS3A92PZT5G](#)
[IRF100S201](#) [JANTX2N5237](#) [2SK2464-TL-E](#) [2SK3818-DL-E](#) [FCA20N60_F109](#) [FDZ595PZ](#) [STD6600NT4G](#) [FSS804-TL-E](#) [2SJ277-DL-E](#)
[2SK1691-DL-E](#) [2SK2545\(Q,T\)](#) [D2294UK](#) [405094E](#) [423220D](#) [MCH6646-TL-E](#) [TPCC8103,L1Q\(CM](#) [367-8430-0972-503](#) [VN1206L](#)
[424134F](#) [026935X](#) [051075F](#) [SBVS138LT1G](#) [614234A](#) [715780A](#) [NTNS3166NZT5G](#) [751625C](#) [873612G](#) [IRF7380TRHR](#)
[IPS70R2K0CEAKMA1](#) [RJK60S3DPP-E0#T2](#) [RJK60S5DPK-M0#T0](#) [APT5010JVFR](#) [APT12031JFLL](#) [APT12040JVR](#) [DMN3404LQ-7](#)
[NTE6400](#) [JANTX2N6796U](#) [JANTX2N6784U](#) [JANTXV2N5416U4](#) [SQM110N05-06L-GE3](#) [SIHF35N60E-GE3](#)