

TAPA

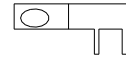
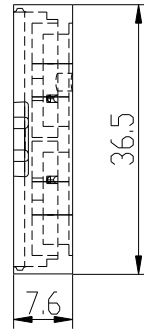

2 terminales

2 battery contacts

BOTON

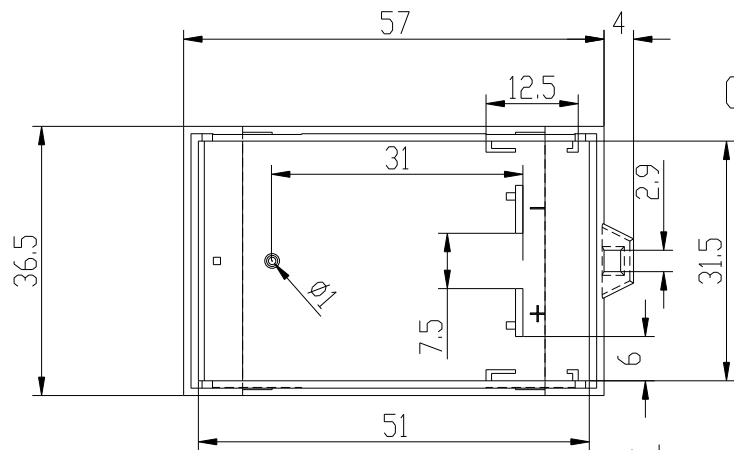
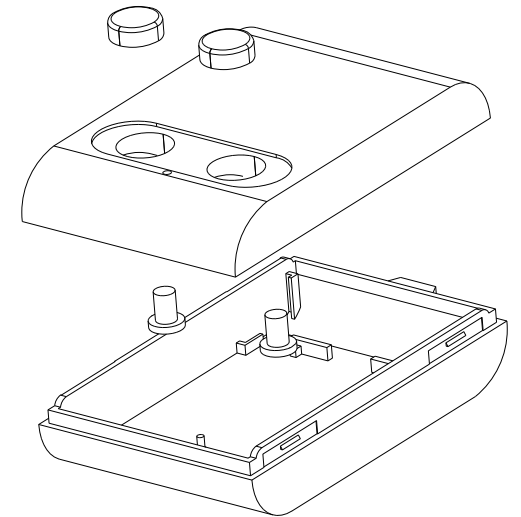
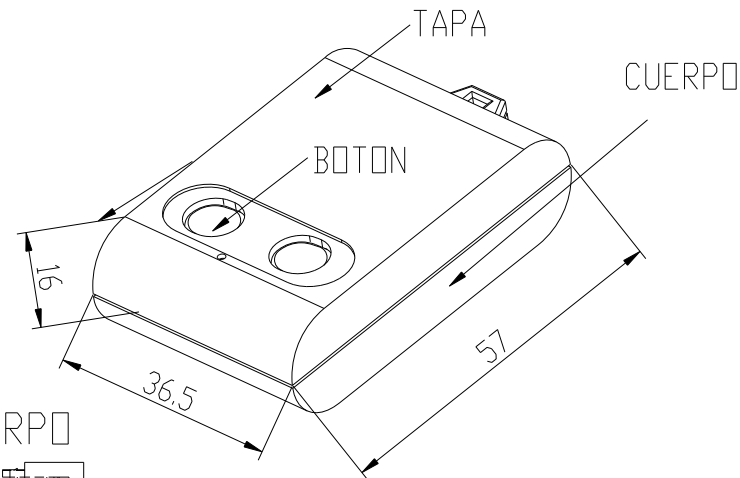
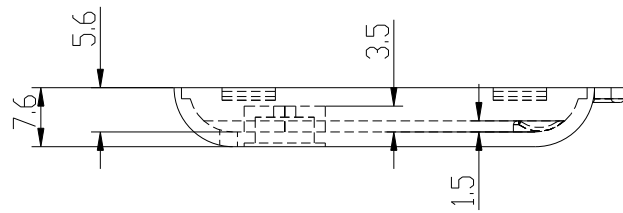
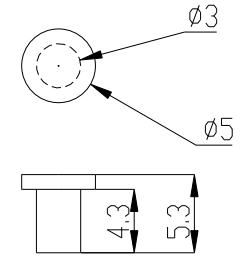

CUERPO

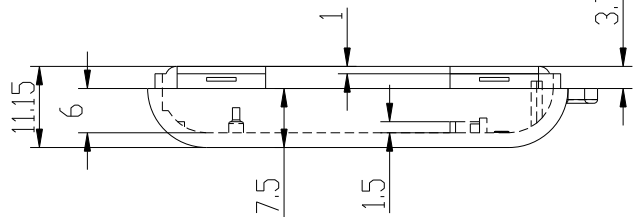
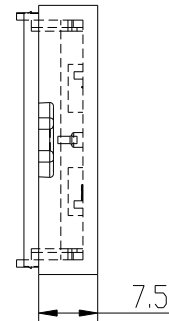

		Proprietary and confidential of Supertronic		
		Plano	Formato DIN A4	
Dibujado	D.R.	Fecha 2007	Peso (gr) 11.8	Dimensiones 56x36x16
Revisado	J.R.	Fecha 2008	Escala 1/1	Material ABS
		Código	Dimensions are in millimeters Tolerance $\pm 0.2\text{mm}$	
Referencia cliente		Modelo PP24		

X-ON Electronics

Largest Supplier of Electrical and Electronic Components

Click to view similar products for [Control Switches](#) category:

Click to view products by [Supertronic](#) manufacturer:

Other Similar products are found below :

[80887-99](#) [80932-99](#) [86855-00](#) [88814-30](#) [1424293-1](#) [HW4S-2TC10](#) [89721-12](#) [89804-08](#) [SSN](#) [RL01801](#) [ASD2L20N-LVO](#) [50051857-17](#)
[50099156-001-05](#) [51.155R-15200](#) [50058920-26](#) [CP-FA51](#) [CP-FA49](#) [ACCU-SC/L-3000](#) [PP9M](#) [PP87G](#) [PP86GA](#) [PP71G](#) [PP70G](#) [PP6G](#)
[PP62G](#) [PP58BL](#) [PP56G](#) [PP86GB](#) [PP77GA](#) [PP76G](#) [PP4M](#) [PP47G](#) [PP46G](#) [PP41M](#) [PP40G](#) [PP32G](#) [RD-20](#) [PP23M](#) [PP12G](#) [PORTAPRO](#)
[POM-2708](#) [PNB-2005](#) [3057.0012](#) [CV-075](#) [CV-140SB](#) [CV-150](#) [CV-150S](#) [214X20XK](#) [CV-180](#) [CV-200MB](#)