



Function

1. High-speed switching

Since release time is 0.1 ms, the MOSFET or other load can be turned off quickly in urgent situations.

2. Space saving

With a built-in control circuit, an external resistor is not needed. This contributes to making substrates more compact.

Applications

These advantages make APSEI Photorelays the ideal choice for:

MOSFET driver

Power supply (Vcc) for electronic circuits



SOP-4

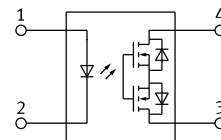

1. LED Anode
2. LED Cathode
- 3, 4. Drain (MOS FET)

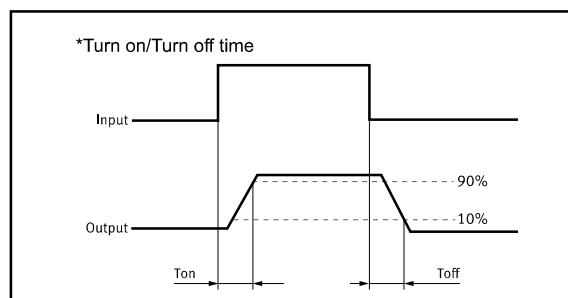

TYPES

Category	Output Rating		Package	Part No.	Packing Quantity
	Drop-out voltage (Typ.)	Short circuit current (Typ.)			
Driver	8V	8uA	SOP-4	GAQV1122S	2000pcs /reel

Absolute Maximum Ratings (Ambient Temperature: 25°C)

Item	Symbol	Value	Units	Note
Input	Continuous LED Current	I _F	50	mA
	Peak LED Current	I _{FP}	1000	mA f=100Hz, duty=1%
	LED Reverse Voltage	V _R	5	V
	Input Power Dissipation	P _{In}	75	mW
I/O Breakdown Voltage	V _{I/O}	2500	V _{Rms}	RH=60%, 1min
Operating Temperature	T _{Opr}	-40 to +85	°C	
Storage Temperature	T _{Stg}	-40 to +100	°C	

Electrical Specifications (Ambient Temperature: 25°C)

Item	Symbol	MIN.	TYP.	MAX.	Units	Conditions
Input	LED Forward Voltage	V _F	1.2	1.4	V	I _F =10mA
	Operation LED Current	I _{F On}	0.5	3.0	mA	V _{oc} =5V
	Recovery LED Current	I _{F Off}	0.35	0.5	mA	V _{oc} =1V
Output	Drop-out Voltage	V _{cc}	6	8	V	I _F =10mA
	Short Circuit Current	I _{sc}	3	8	uA	I _F =10mA
Transmis sion	Turn-On Time	T _{On}	0.23		ms	I _F =10mA
	Turn-Off Time	T _{Of}	0.03		ms	C _L =1000pF
Coupled	I/O Isolation Resistance	R _{I/O}	10 ¹⁰		Ω	DC500V
	I/O Capacitance	C _{I/O}	0.8	1.5	pF	f=1MHz

Reference Data

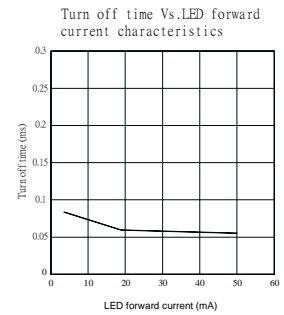
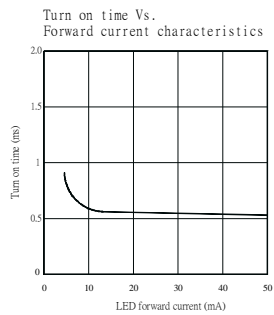
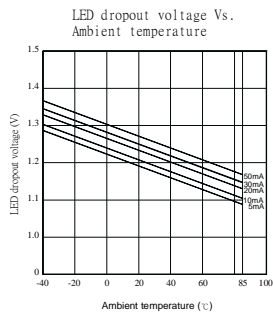
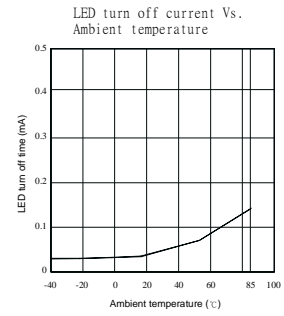
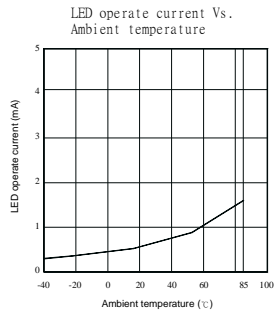
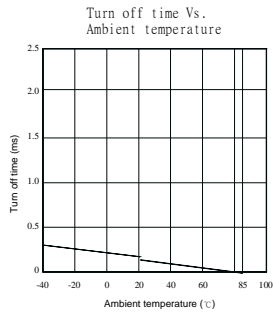
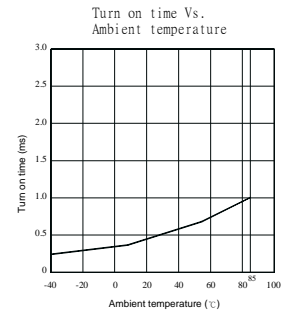
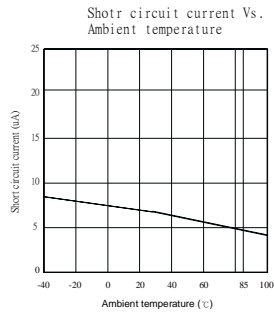
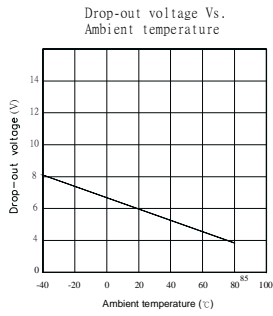

Dimensions

4-SOP

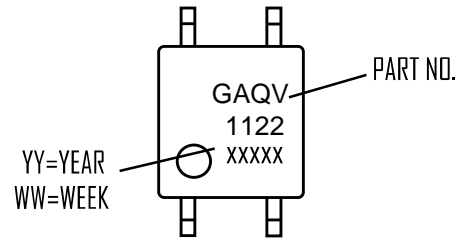

Surface mount terminal type

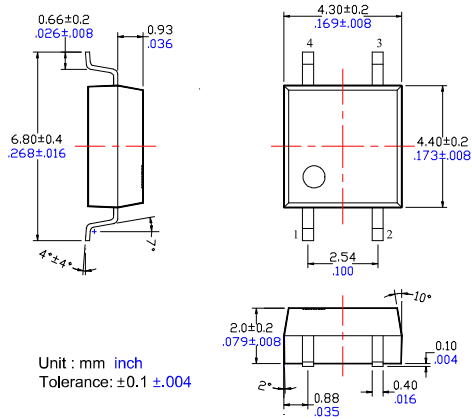

Recommended mounting pad (Top view)

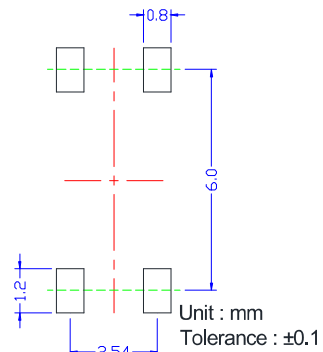

Tape dimensions

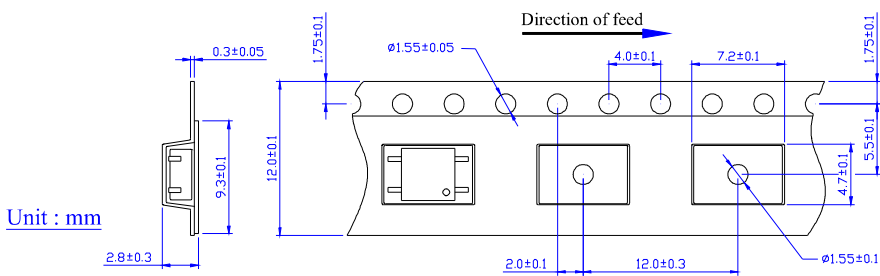

Dimensions of tape reel

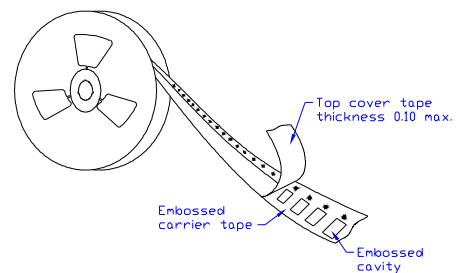
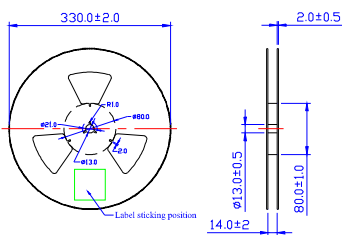

X-ON Electronics

Largest Supplier of Electrical and Electronic Components

Click to view similar products for [Transistor Output Optocouplers](#) category:

Click to view products by [SUPSiC](#) manufacturer:

Other Similar products are found below :

[LTV-814S-TA](#) [LTV-852S](#) [66095-001](#) [PS2561-1-A](#) [PS2561A-1-W-A](#) [PS2561L1-1-A](#) [PS2561L-1-V-A](#) [PS2706-1-A](#) [PS2815-1-A](#) [MRF658](#)
[ELD207\(TA\)](#) [ILD2-X006](#) [ILQ615-3X016](#) [LDA102S](#) [SFH615A-4XSM TR](#) [PS2561DL-1Y-F3-A](#) [PS2561L1-1-L-A](#) [PS2562-1-V-A](#) [PS2565L-](#)
[1-A](#) [PS2581L2-A](#) [PS2701A-1-F3-P-A](#) [PS2711-1-A](#) [PS2801-1-F3-P-A](#) [PS2833-4-A](#) [PS2841-4A-AX](#) [LTV-702FS](#) [LTV-702V](#) [LTV-702VB](#)
[LTV-816S-TA](#) [TCET2100](#) [TLP290-4\(E\(T](#) [IL215AT](#) [WPPC-A11066AA](#) [WPPC-A11066AD](#) [WPPC-A11084ASS](#) [WPPC-A21068AA](#) [WPPC-](#)
[D11066AA](#) [WPPC-D21068ED](#) [WPPC-D410616EA](#) [WPPC-D410616ED](#) [X4IAC24A](#) [4N26-X001](#) [EL1010\(TA\)-VG](#) [SFH600-2X007](#)
[TCMT1118](#) [VO206AT](#) [WPPC-D21068EA](#) [WPPC-D11064AD](#) [WPPC-A410616AD](#) [WPPC-A21068AD](#)