



### Features

- Low driver power requirements (TTL/CMOS Compatible)
- No moving parts
- High reliability
- Arc-Free with no snubbing circuits
- 3750Vrms Input/Output isolation

### Applications

- Telecommunications (PC, Electronic notepad)
- Measuring and Testing equipment
- Industrial control
- Security equipments
- High speed inspection machine Arc-Free with no snubbing circuits



SMD-6



DIP-6

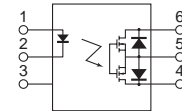

1. LED Anode
2. LED Cathode
4. Drain (MOS FET)
5. Source (MOS FET)
6. Drain (MOS FET)

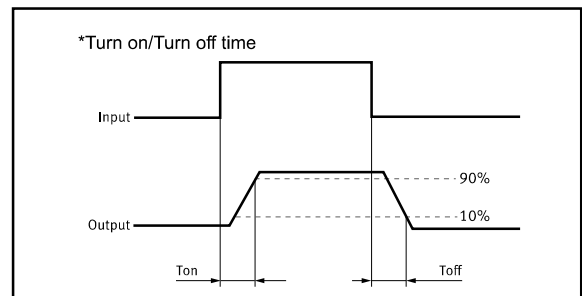

### TYPES

Category	Output rating		Package	Part No.	Packing quantity
	Load voltage	Load current			
AC/DC	600V	80mA	DIP6	GAQV216E	50pcs/tube
			SMD6	GAQV216EH	1000pcs/reel

Absolute Maximum Ratings (Ambient Temperature: 25 °C)

Item		Symbol	Value	Units	Note
Input	Continuous LED Current	I <sub>F</sub>	50	mA	
	Peak LED Current	I <sub>FP</sub>	1000	mA	f=100Hz, duty=1%
	LED Reverse Voltage	V <sub>R</sub>	5	V	
	Input Power Dissipation	P <sub>In</sub>	75	mW	
Output	Load Voltage	V <sub>L</sub>	600	V(AC peak or DC)	
	Load Current	I <sub>L</sub>	80	mA	
	Peak Load Current	I <sub>Peak</sub>	120	mA	100ms(1 pulse)
	Output Power Dissipation	P <sub>out</sub>	450	mW	
Total Power Dissipation		P <sub>T</sub>	500	mW	
I/O Breakdown Voltage		V <sub>I/O</sub>	3750	V <sub>rms</sub>	RH=60%, 1min
Operating Temperature		T <sub>opr</sub>	-40 to +85	°C	
Storage Temperature		T <sub>stg</sub>	-40 to +100	°C	
Pin Soldering Temperature		T <sub>sol</sub>	260	°C	10 sec max.

Electrical Specifications (Ambient Temperature: 25 °C)

Item		Symbol	MIN.	TYP.	MAX.	Units	Conditions
Input	LED Forward Voltage	V <sub>F</sub>		1.2	1.5	V	I <sub>F</sub> =10mA
	Operation LED Current	I <sub>F on</sub>		0.5	5.0	mA	
	Recovery LED Current	I <sub>F off</sub>		0.35	0.5	mA	
	Recovery LED Voltage	V <sub>F off</sub>	0.7			V	
Output	On-Resistance	R <sub>on</sub>		35	70	Ω	I <sub>F</sub> =5mA, I <sub>L</sub> =100mA, Time to flow is within 1 sec.
	Off-State Leakage Current	I <sub>Leak</sub>			1	uA	V <sub>L</sub> =Rating
	Output Capacitance	C <sub>out</sub>		100		pF	V <sub>L</sub> =0, f=1MHz
Transmis sion	Turn-On Time	T <sub>on</sub>		0.5	1.0	ms	I <sub>F</sub> =5mA, I <sub>L</sub> =100mA,
	Turn-Off Time	T <sub>off</sub>		0.02	0.2	ms	
Coupled	I/O Isolation Resistance	R <sub>I/O</sub>	10 <sup>10</sup>			Ω	DC500V
	I/O Capacitance	C <sub>I/O</sub>		0.8	1.5	pF	f=1MHz

## Reference Data

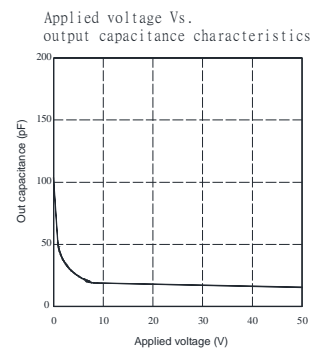
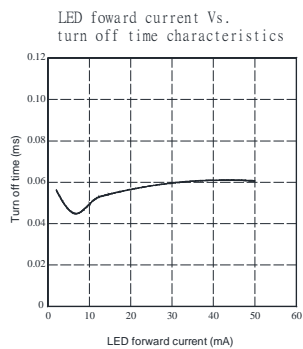
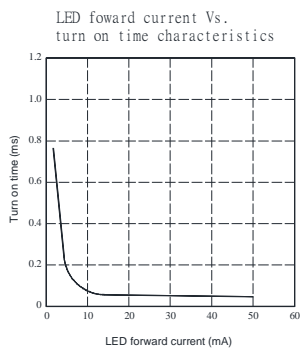
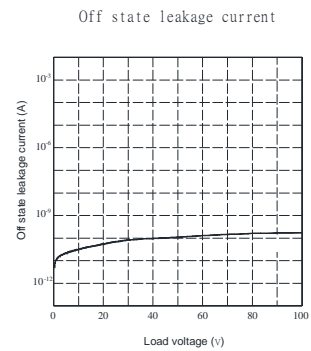
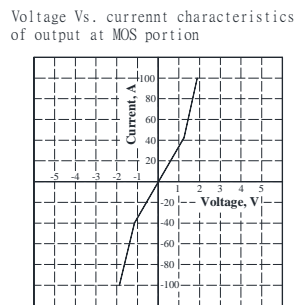
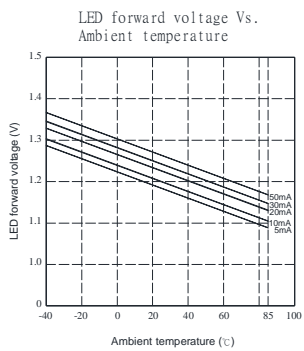
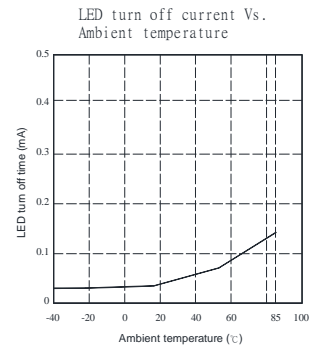
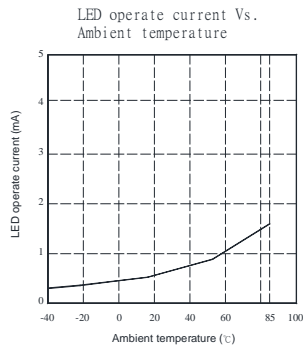
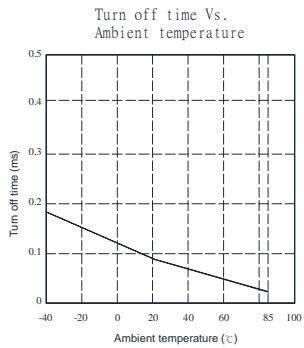
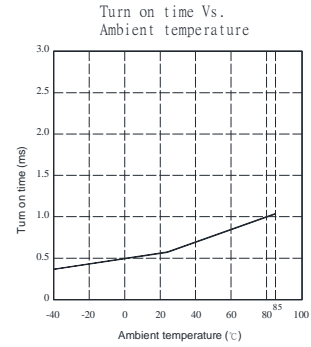
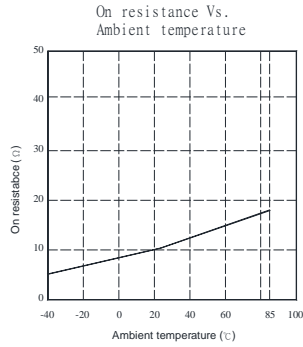
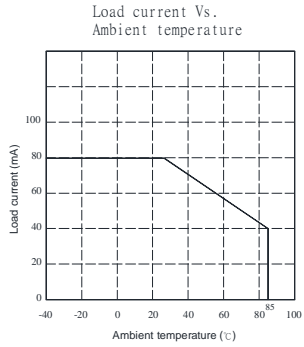

## Dimensions

### 6-SMD



### Dimensions

mm inch

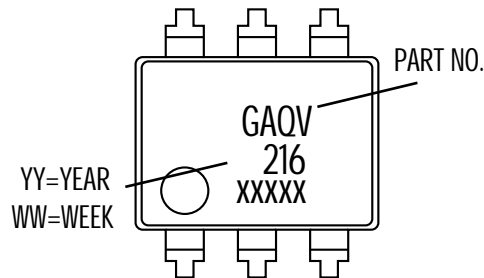

### Surface mount terminal type

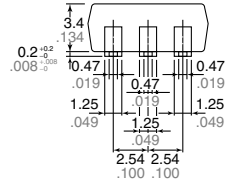
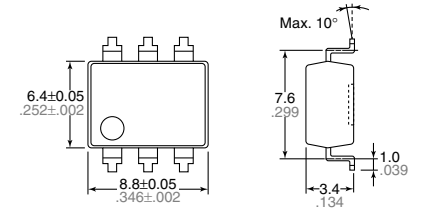

Terminal thickness = 0.25 .010

General tolerance: ±0.1 ±.004

### PC board pattern (Top view)

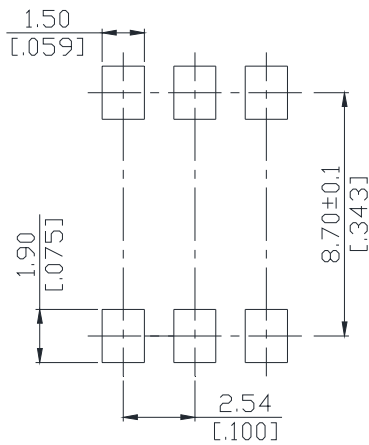

Unit : mm [inch]  
Tolerance : ±0.1

### Tape dimensions

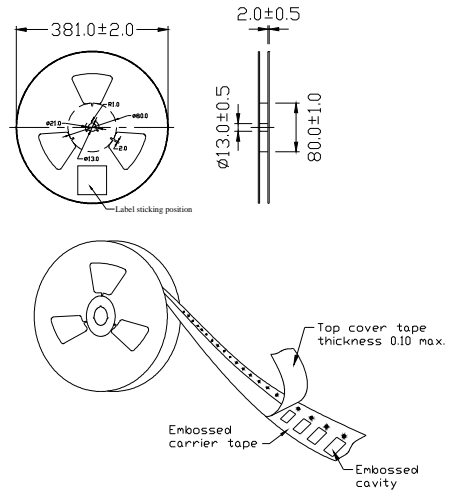

### Dimensions of tape reel

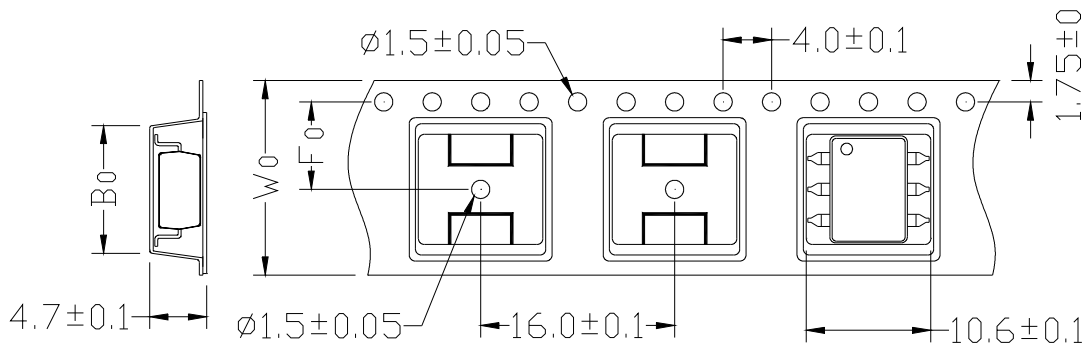

Unit: mm

TYPE	B0±0.1	F0±0.1	W0±0.1	13"REEL/PCS
6P	9.4	7.5	16	1000

## Dimensions 6-DIP



Dimensions

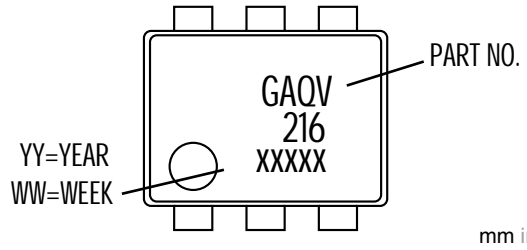

mm inch

Through hole terminal type

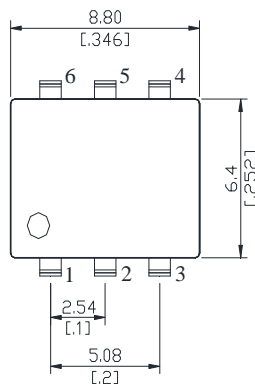
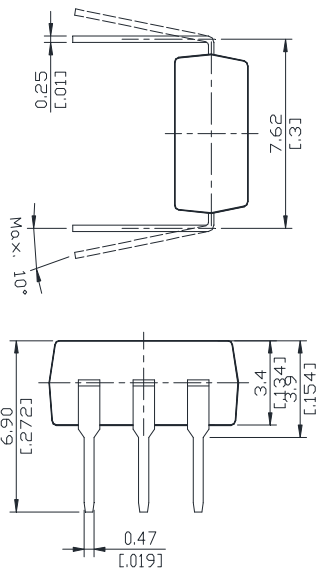

Unit : mm inch  
Tolerance: +0.2 +.007

PC board patter

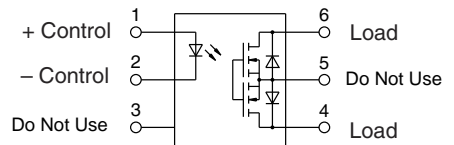
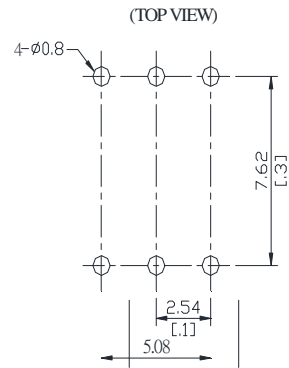

### DIP type

Devices are packaged in a tube so that pin No. 1 is on the stopper B side. Observe correct orientation when mounting them on PC boards.

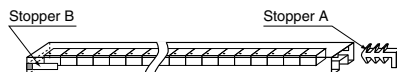

## X-ON Electronics

Largest Supplier of Electrical and Electronic Components

*Click to view similar products for [Solid State Relays - PCB Mount](#) category:*

*Click to view products by [SUPSiC](#) manufacturer:*

Other Similar products are found below :

[M86F-2W](#) [M90F-2W](#) [M90F-2Y](#) [901-SX](#) [G2-1A07-ST](#) [G2-1A07-TT](#) [G2-1B02-TT](#) [G2-DA06-ST](#) [PLA134S](#) [DS11-1005](#) [AQH3213J](#)  
[AQV112KLAXJ](#) [AQV210EHJ](#) [AQV212J](#) [AQV252GAJ](#) [AQY210ST](#) [AQY221N2SJ](#) [AQY221R2SJ](#) [EFR1200480A150](#) [901-7](#) [LCA220](#)  
[LCB110S](#) [1618400-5](#) [SR75-1ST](#) [AQV112KLJ](#) [AQV212AJ](#) [AQV212SXJ](#) [AQV238AD01](#) [AQV252GAXJ](#) [AQW414TS](#) [AQY212ST](#)  
[AQY221R2VJ](#) [AQY275AXJ](#) [AQY414SXE01](#) [G2-1A02-ST](#) [G2-1A03-ST](#) [G2-1A03-TT](#) [G2-1A05-ST](#) [G2-1A06-TT](#) [G2-1A23-TT](#) [G2-1B01-](#)  
[ST](#) [G2-1B01-TT](#) [G2-1B02-ST](#) [G2-DA03-ST](#) [G2-DA03-TT](#) [G2-DA06-TT](#) [3-1617776-2](#) [CTA2425](#) [LBA110S](#) [LBB110S](#)