



New Parts: SiC PhotoMosRelay

Features

- Low driver power requirements (TTL/CMOS Compatible)
- No moving parts
- High reliability
- Arc-Free with no snubbing circuits
- 3750Vrms Input/Output isolation

Applications

- Telecommunications (PC, Electronic notepad)
- Measuring and Testing equipment
- Industrial control
- Security equipments
- High speed inspection machine Arc-Free with no snubbing circuits



SMD-5



DIP-5

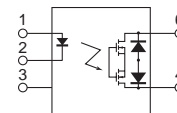

1. LED Anode
2. LED Cathode
4. Drain (MOS FET)
6. Drain (MOS FET)

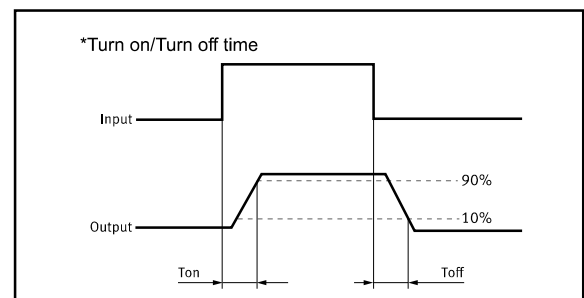
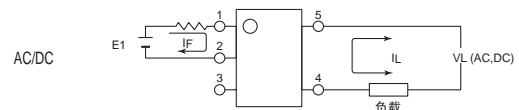

TYPES

Category	Output rating		Package	Part No.	Packing quantity
	Load voltage	Load current			
AC/DC	1800V	30mA	DIP5	GAQV278AE	50pcs/tube
			SMD5	GAQV278AEH	1000pcs/1reel

Absolute Maximum Ratings (Ambient Temperature: 25 °C)

Item		Symbol	Value	Units	Note
Input	Continuous LED Current	I _F	50	mA	
	Peak LED Current	I _{FP}	1000	mA	f=100Hz, duty=1%
	LED Reverse Voltage	V _R	5	V	
	Input Power Dissipation	P _{In}	75	mW	
Output	Load Voltage	V _L	1800	V(AC peak or DC)	
	Load Current	I _L	30	mA	
	Peak Load Current	I _{Peak}	500	mA	100ms(1 pulse)
	Output Power Dissipation	P _{out}	450	mW	
Total Power Dissipation		P _T	500	mW	
I/O Breakdown Voltage		V _{I/O}	3750	V _{rms}	RH=60%, 1min
Operating Temperature		T _{opr}	-40 to +85	°C	
Storage Temperature		T _{stg}	-40 to +100	°C	
Pin Soldering Temperature		T _{sol}	260	°C	10 sec max.

Electrical Specifications (Ambient Temperature: 25 °C)

Item		Symbol	MIN.	TYP.	MAX.	Units	Conditions
Input	LED Forward Voltage	V _F	1.10	1.33	1.5	V	I _F =10mA
	Operation LED Current	I _{F on}		2.0	5.0	mA	
	Recovery LED Current	I _{F off}		0.35	0.8	mA	
	Recovery LED Voltage	V _{F off}	0.7	1.2		V	
Output	On-Resistance	R _{on}	200	160	260	Ω	I _F =10mA, I _L = Rating, Time to flow is within 1 sec.
	Off-State Leakage Current	I _{Leak}			1	uA	V _L =Rating
	Output Capacitance	C _{out}		10		pF	V _L =0, f=1MHz
Transmis sion	Turn-On Time	T _{on}		0.08	0.15	ms	I _F =5mA, I _L =100mA,
	Turn-Off Time	T _{off}		0.05	0.15	ms	
Coupled	I/O Isolation Resistance	R _{I/O}	10 ¹⁰			Ω	DC500V
	I/O Capacitance	C _{I/O}		0.8	1.3	pF	f=1MHz

Reference Data

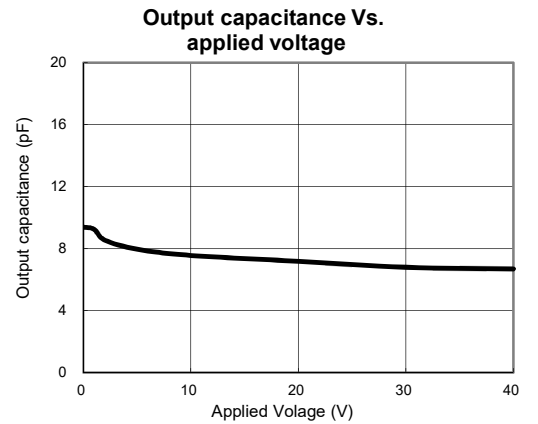
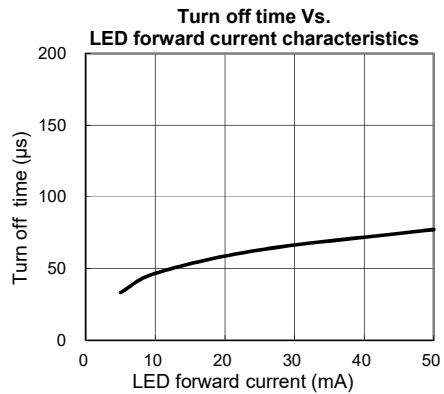
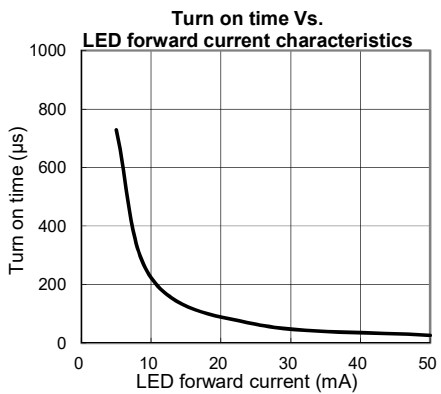
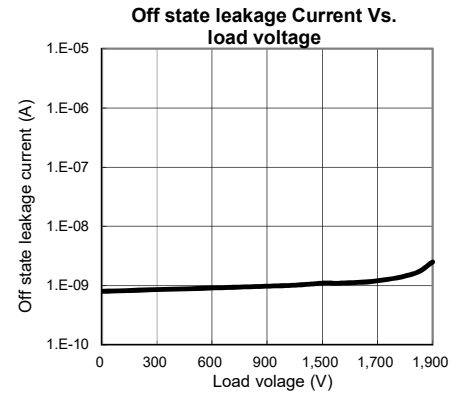
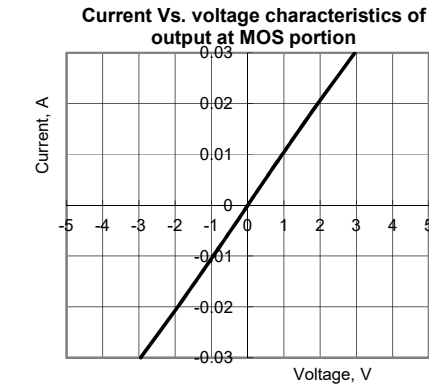
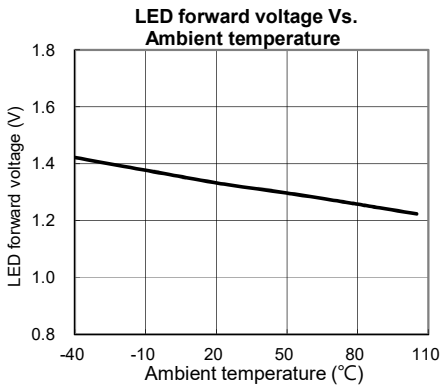
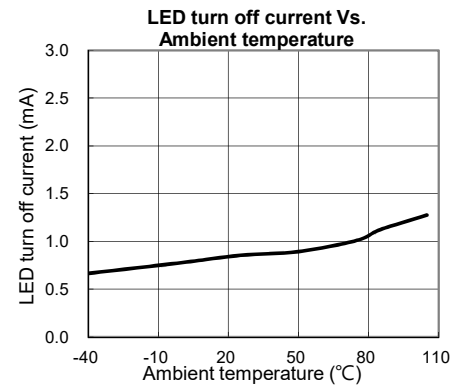
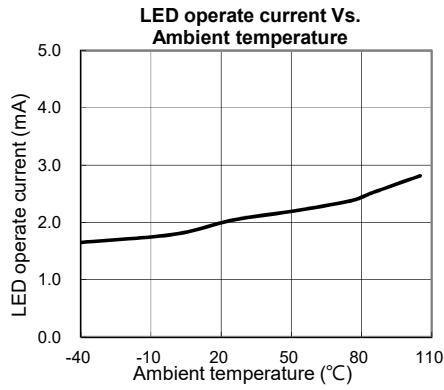
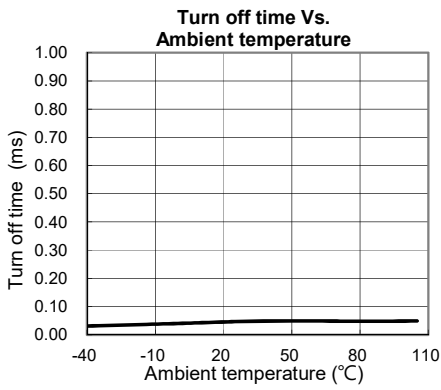
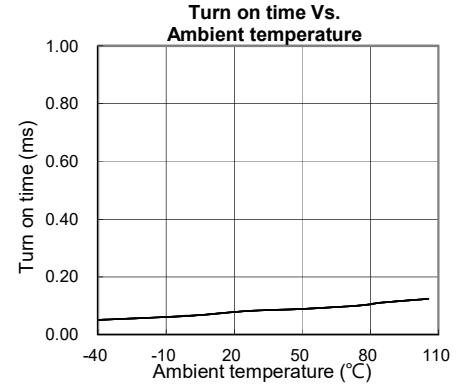
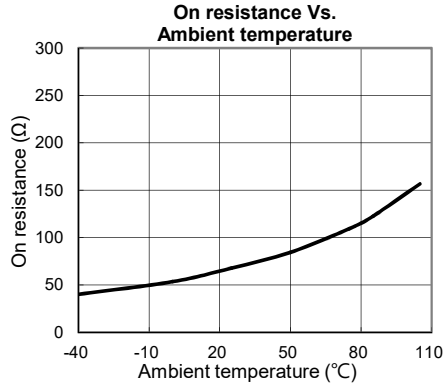
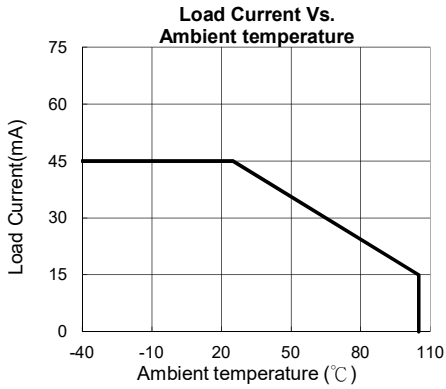

Dimensions

SMD-5



Dimensions

mm inch

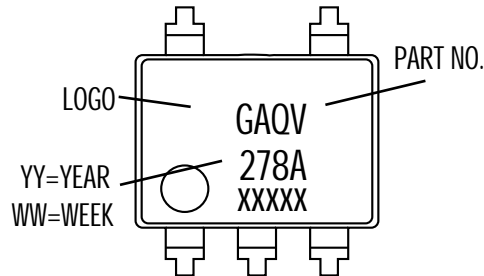

Surface mount terminal type

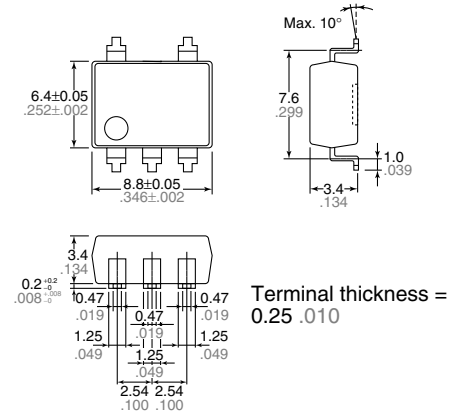

General tolerance: $\pm 0.1 \pm .004$

PC board pattern (Top view)

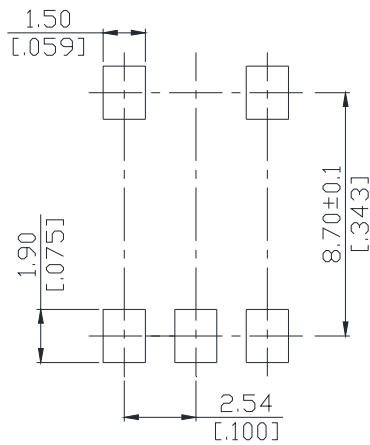

Unit : mm [inch]
Tolerance : ± 0.1

Tape dimensions

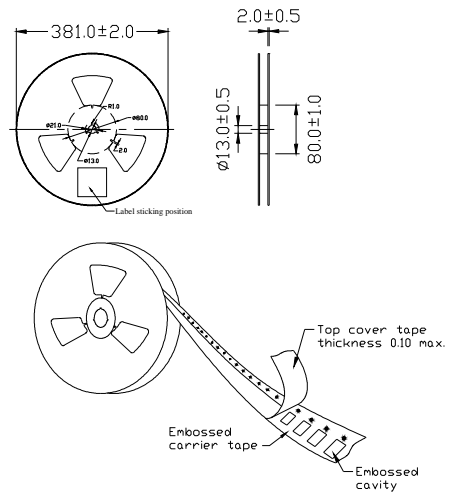

Dimensions of tape reel

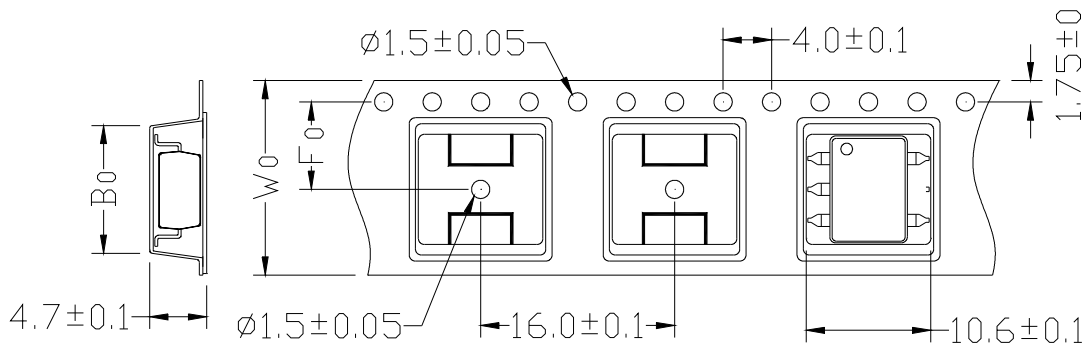

Unit: mm

TYPE	B0 ± 0.1	F0 ± 0.1	W0 ± 0.1	13"REEL/PCS
6P	9.4	7.5	16	1000

Dimensions

DIP-5

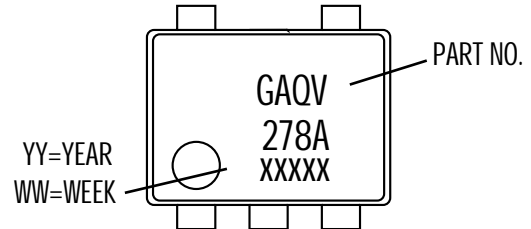

Through hole terminal type

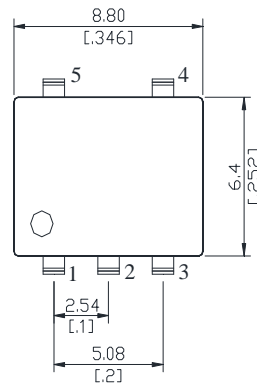
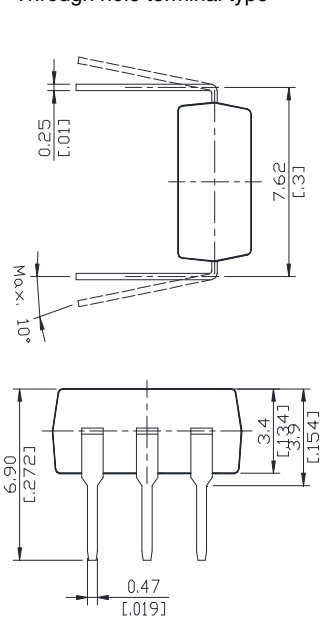

PC board patter

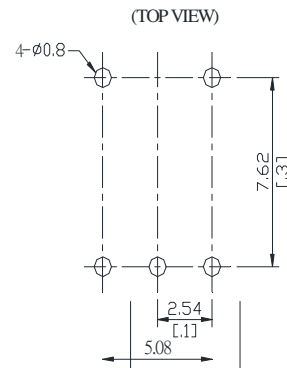

Unit : mm inch
Tolerance: +0.2 +.007

DIP type

Devices are packaged in a tube so that pin No. 1 is on the stopper B side. Observe correct orientation when mounting them on PC boards.

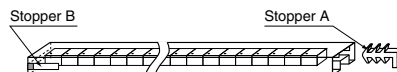

X-ON Electronics

Largest Supplier of Electrical and Electronic Components

Click to view similar products for [Solid State Relays - PCB Mount](#) category:

Click to view products by [SUPSiC](#) manufacturer:

Other Similar products are found below :

[M86F-2W](#) [M90F-2W](#) [M90F-2Y](#) [901-SX](#) [G2-1A07-ST](#) [G2-1A07-TT](#) [G2-1B02-TT](#) [G2-DA06-ST](#) [PLA134S](#) [DS11-1005](#) [AQH3213J](#)
[AQV112KLAXJ](#) [AQV210EHJ](#) [AQV212J](#) [AQV252GAJ](#) [AQY210ST](#) [AQY221N2SJ](#) [AQY221R2SJ](#) [EFR1200480A150](#) [901-7](#) [LCA220](#)
[LCB110S](#) [1618400-5](#) [SR75-1ST](#) [AQV112KLJ](#) [AQV212AJ](#) [AQV212SXJ](#) [AQV238AD01](#) [AQV252GAXJ](#) [AQW414TS](#) [AQY212ST](#)
[AQY221R2VJ](#) [AQY275AXJ](#) [AQY414SXE01](#) [G2-1A02-ST](#) [G2-1A03-ST](#) [G2-1A03-TT](#) [G2-1A05-ST](#) [G2-1A06-TT](#) [G2-1A23-TT](#) [G2-1B01-](#)
[ST](#) [G2-1B01-TT](#) [G2-1B02-ST](#) [G2-DA03-ST](#) [G2-DA03-TT](#) [G2-DA06-TT](#) [3-1617776-2](#) [CTA2425](#) [LBA110S](#) [LBB110S](#)