



Features

- Low driver power requirements (TTL/CMOS Compatible)
- No moving parts
- High reliability
- Arc-Free with no snubbing circuits
- 3750Vrms Input/Output isolation

Applications

- Telecommunications (PC, Electronic notepad)
- Measuring and Testing equipment
- Industrial control
- Security equipments
- High speed inspection machine

Outline Dimensions

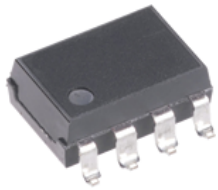

SMD-8



DIP-8

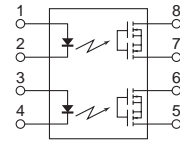

1,3. LED Anode
2,4. LED Cathode
5,6. Drain (MOS FET)
7,8. Drain (MOS FET)

TYPES

Category	Output rating		Package	Part No.	Packing quantity
	Load voltage	Load current			
AC/DC	60V	500mA	DIP8	GAQW412E	50pcs/tube
			SMD8	GAQW412EH	1000pcs/1reel

Absolute Maximum Ratings (Ambient Temperature: 25°C)

Item		Symbol	Value	Units	Note
Input	Continuous LED Current	I _F	50	mA	
	Peak LED Current	I _{FP}	1000	mA	f=100Hz, duty=1%
	LED Reverse Voltage	V _R	5	V	
	Input Power Dissipation	P _{in}	75	mW	
Output	Load Voltage	V _L	60	V(AC peak or DC)	
	Load Current	I _L	500	mA	
	Peak Load Current	I _{Peak}	0.6	A	1ms(1 pulse)
	Output Power Dissipation	P _{out}	300	mW	
Total Power Dissipation		P _T	350	mW	
I/O Breakdown Voltage		V _{I/O}	3750	Vrms	RH=60%, 1min
Operating Temperature		T _{opr}	-40 to +85	°C	
Storage Temperature		T _{stg}	-40 to +100	°C	
Pin Soldering Temperature		T _{sol}	260	°C	10 sec max.

Electrical Specifications (Ambient Temperature: 25°C)

Item		Symbol	MIN.	TYP.	MAX.	Units	Conditions
Input	LED Forward Voltage	V _F		1.2	1.5	V	IF=10mA
	Operation LED Current	I _{Fon}		0.5	3.0	mA	
	Recovery LED Current	I _{Foff}	0.1	0.4		mA	
	Recovery LED Voltage	V _{Foff}	0.5			V	
Output	On-Resistance	R _{on}		1	3	Ω	IF=0mA, IL=50mA, Time to flow is within 1 sec.
	Off-State Leakage Current	I _{Leak}			1	uA	IF=5mA, VL=60V
	Output Capacitance	C _{out}		165		pF	IF=5mA, VL=0, f=1MHz
Transmission	Turn-On Time	T _{on}		0.5	1.5	ms	IF=5mA, IL=50mA
	Turn-Off Time	T _{off}		0.25	2.0	ms	
Coupled	I/O Isolation Resistance	R _{I/O}	10 ¹⁰			Ω	DC500V
	I/O Capacitance	C _{I/O}		0.8		pF	f=1MHz

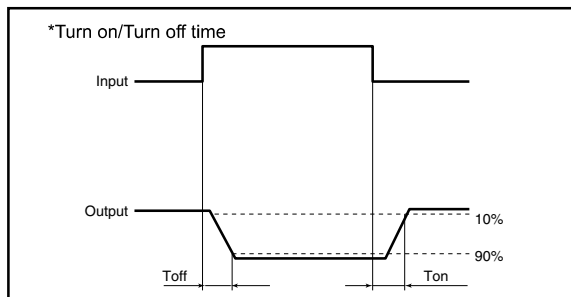

Reference Data

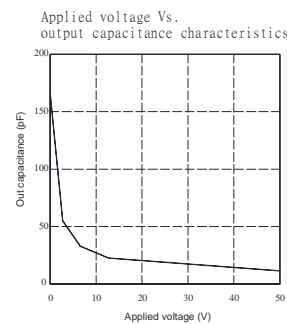
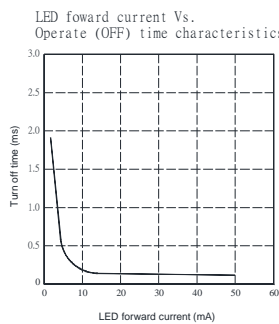
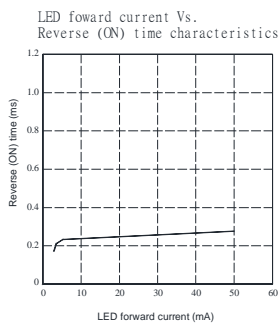
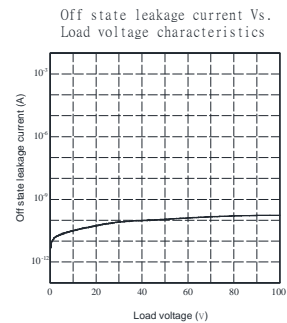
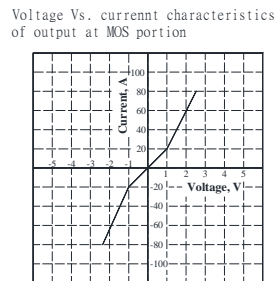
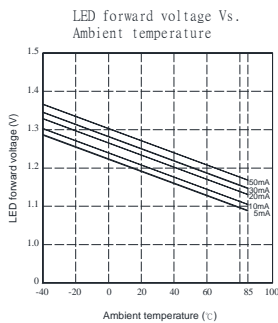
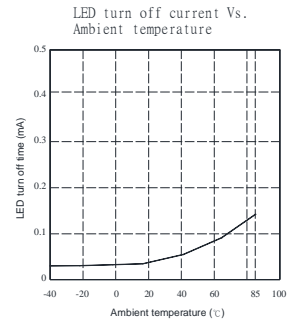
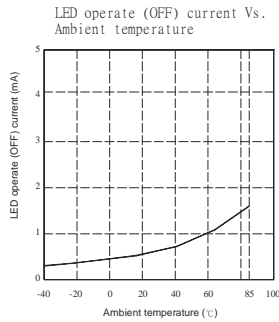
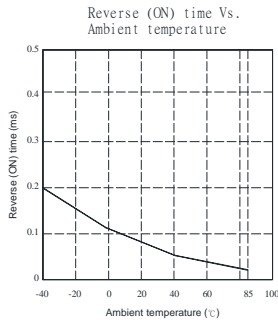
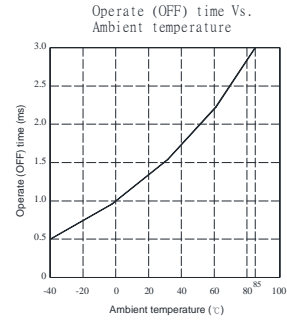
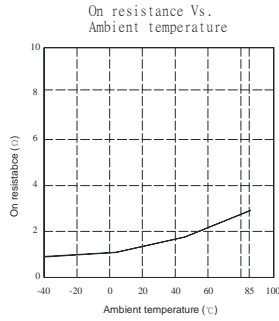
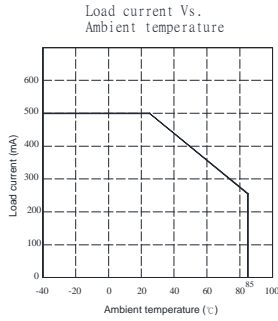

8-DIP

Dimensions

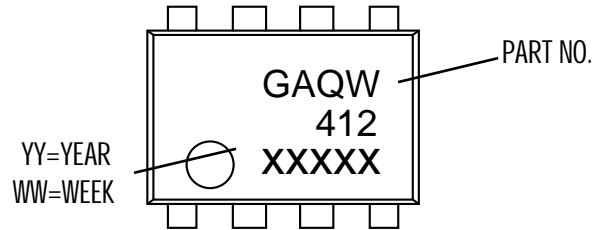

Through hole terminal type

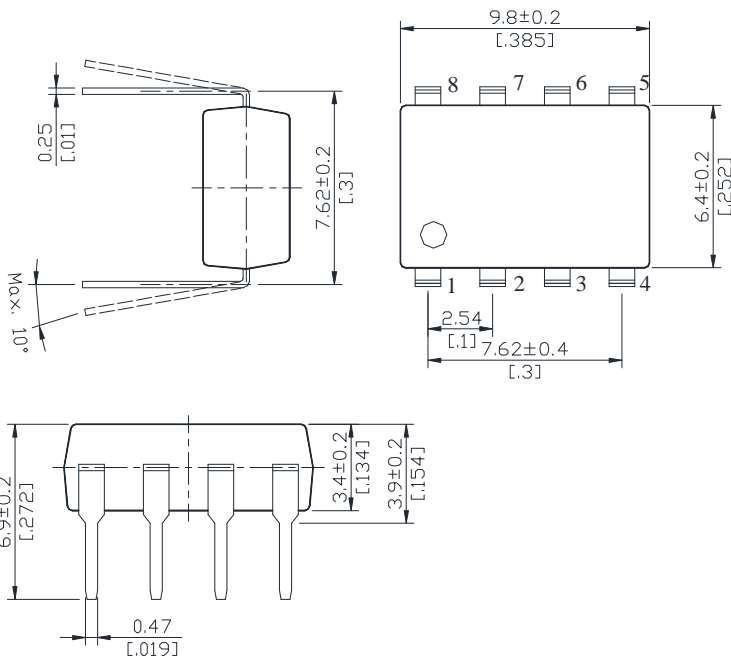

PC board pattern

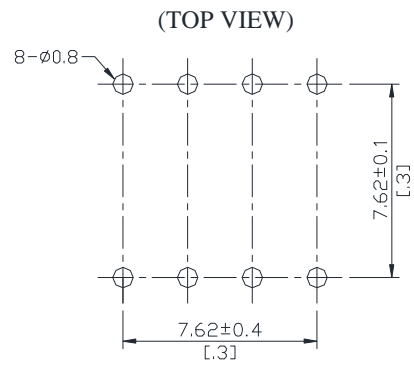

Unit : mm inch
Tolerance : +0.2 +.007

DIP type

Devices are packaged in a tube so that pin No. 1 is on the stopper B side. Observe correct orientation when mounting them on PC boards.

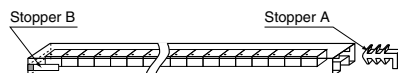

8-SMD

Dimensions

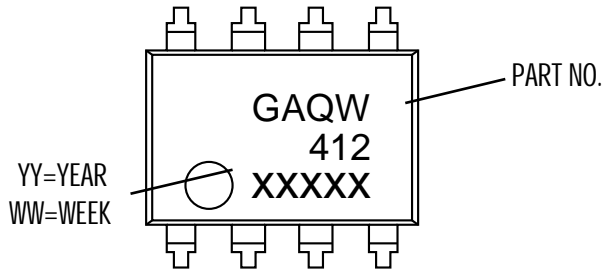

Surface mount terminal type

PC board pattern

(Top view)

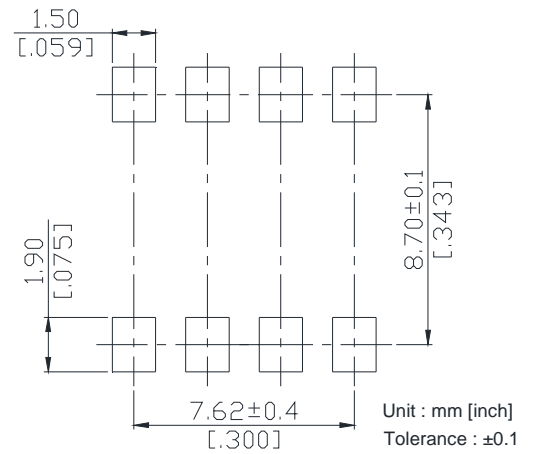
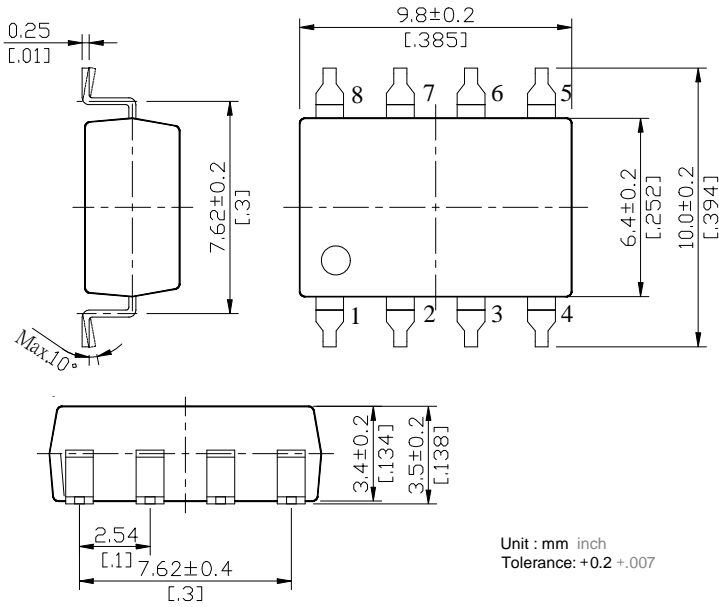

Tape dimensions

Direction of feed

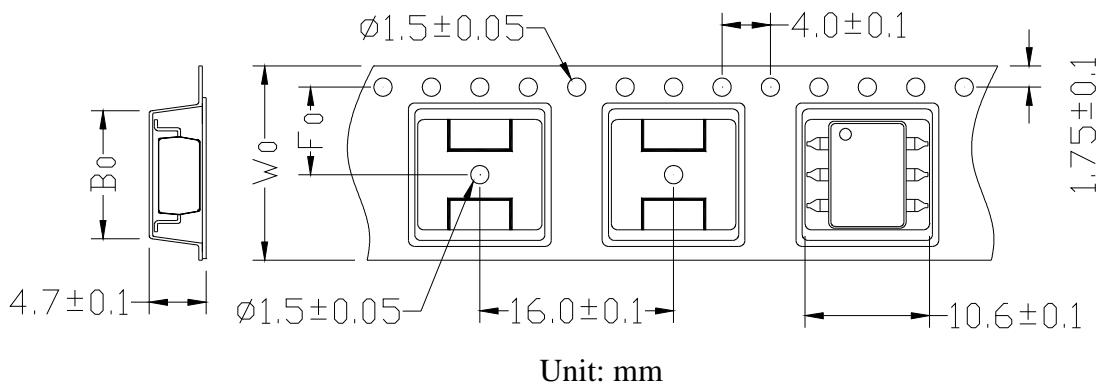

Dimensions of tape reel

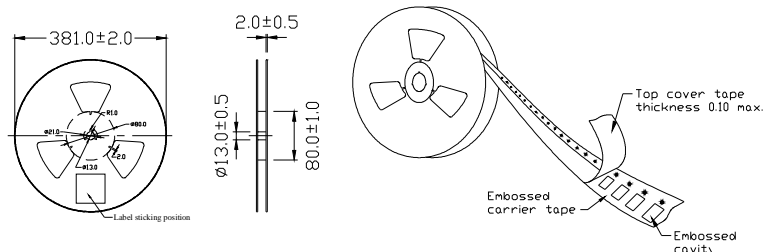

X-ON Electronics

Largest Supplier of Electrical and Electronic Components

Click to view similar products for [Solid State Relays - PCB Mount](#) category:

Click to view products by [SUPSiC](#) manufacturer:

Other Similar products are found below :

[M86F-2W](#) [M90F-2W](#) [M90F-2Y](#) [901-SX](#) [G2-1A07-ST](#) [G2-1A07-TT](#) [G2-1B02-TT](#) [G2-DA06-ST](#) [PLA134S](#) [DS11-1005](#) [AQH3213J](#)
[AQV112KLAXJ](#) [AQV210EHJ](#) [AQV212J](#) [AQV252GAJ](#) [AQY210ST](#) [AQY221N2SJ](#) [AQY221R2SJ](#) [EFR1200480A150](#) [901-7](#) [LCA220](#)
[LCB110S](#) [1618400-5](#) [SR75-1ST](#) [AQV112KLJ](#) [AQV212AJ](#) [AQV212SXJ](#) [AQV238AD01](#) [AQV252GAXJ](#) [AQW414TS](#) [AQY212ST](#)
[AQY221R2VJ](#) [AQY275AXJ](#) [AQY414SXE01](#) [G2-1A02-ST](#) [G2-1A03-ST](#) [G2-1A03-TT](#) [G2-1A05-ST](#) [G2-1A06-TT](#) [G2-1A23-TT](#) [G2-1B01-](#)
[ST](#) [G2-1B01-TT](#) [G2-1B02-ST](#) [G2-DA03-ST](#) [G2-DA03-TT](#) [G2-DA06-TT](#) [3-1617776-2](#) [CTA2425](#) [LBA110S](#) [LBB110S](#)