

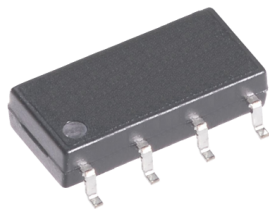

Features

- * SOP package 8 Pin type in miniature design (4.4×9.37×2.1mm/.173×.37×.083inch)
- * Low driver power requirements (TTL/CMOS Compatible)
- * Contact form: Normally-On (1a) and Normally-Off (1b)
- * Load voltage: 60V max.
- * On-Resistance: 50Ω max.
- * 1500Vrms Input/Output isolation
- * Tape & Reel version available



SOP-8

Applications

- * Telecommunications (PC, Electronic notepad)
- * Measuring and Testing equipment
- * Industrial control
- * Security equipments
- * High speed inspection machine

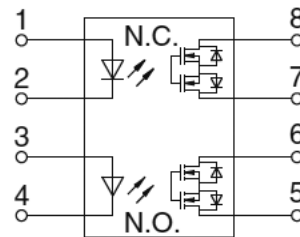

- 1,3. LED Anode
- 2,4. LED Cathode
- 5,6. Drain (MOS FET)1a
- 7,8. Drain (MOS FET)1b

Normally-On

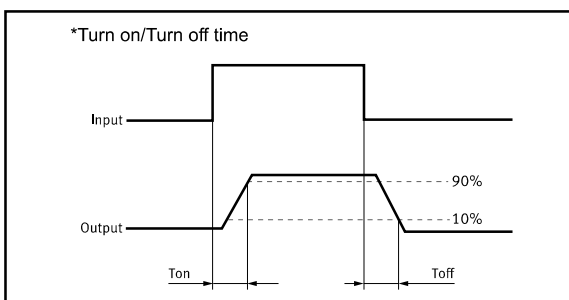

Normally-Off

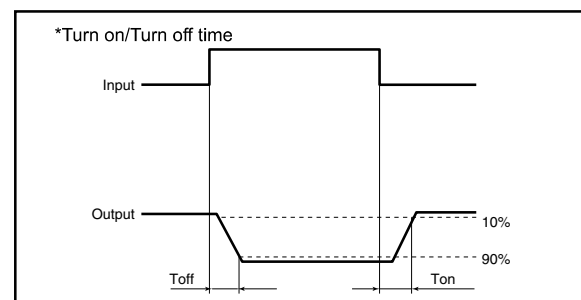

TYPES

Category	Output rating ^{**1}		Part No.	Packing quantity
	Load voltage	Load current		
AC/DC	60V	400mA	SOP-8 GAQW612S	Tape and reel 1-reel: 1,000 pcs.

Absolute Maximum Ratings (Ambient Temperature: 25°C)

Item		Symbol	Value	Units	Note
Input	Continuous LED Current	IF	50	mA	
	Peak LED Current	IFP	1000	mA	f=100Hz, duty=1%
	LED Reverse Voltage	VR	5	V	
	Input Power Dissipation	PIIn	75	mW	
Output	Load Voltage	VL	60	V(AC peak or DC)	
	Load Current	IL	400	mA	
	Peak Load Current	IPeak	1.0	A	1ms(1 pulse)
	Output Power Dissipation	Pout	450	mW	
Total Power Dissipation		PT	500	mW	
I/O Breakdown Voltage		VI/O	1500	Vrms	RH=60%, 1min
Operating Temperature		TOpr	-40 to +85	-40 to +85	
Storage Temperature		TStg	-40 to +100	-40 to +100	
Pin Soldering Temperature		TSol	260	260	10 sec max.

Electrical Specifications (Ambient Temperature: 25°C)

Item		Symbol	MIN.	TYP.	MAX.	Units	Conditions
Input	LED Forward Voltage	VF		1.2	1.4	V	IF=10mA
	Operation LED Current	IF On		0.5	3.0	mA	
	Recovery LED Current	IF Off		0.35	0.5	mA	
	Recovery LED Voltage	VF Off	0.5			V	
Output	On-Resistance	ROn		1(N.O.)	1.4(N.O.)	Ω	IF=5mA (N.O.) IF=0mA (N.C) IL=100mA Time to flow is within 1 sec.
				1(N.C.)	3(N.C.)		
	Off-State Leakage Current	ILeak			10	uA	IF=0mA (N.O.) IF=5mA (N.C) VL= Rating
	Output Capacitance	COut		165		pF	IF=5mA, VL=0, f=1MHz
Transmission	Turn-On Time	TOn		0.23(N.O.)	0.5(N.O.)	ms	IF=5mA, IL=50mA
				0.02(N.C.)	1.0(N.C.)		
	Turn-Off Time	TOff		0.03(N.O.)	0.2(N.O.)	ms	
				0.5(N.C.)	3.0(N.C.)		
Coupled	I/O Isolation Resistance	RI/O	10 ¹⁰			Ω	DC500V
	I/O Capacitance	CI/O		0.8		pF	f=1MHz

Reference Data

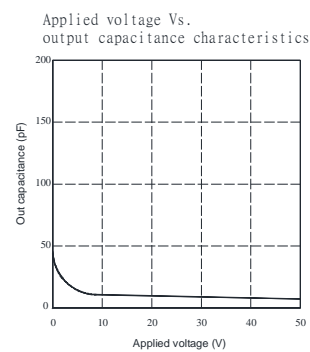
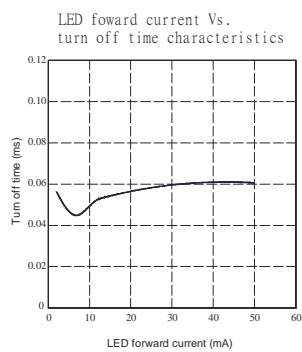
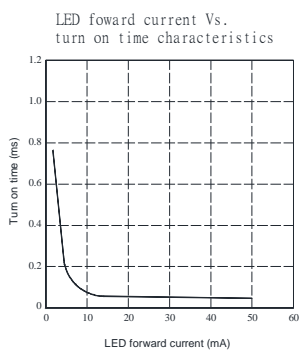
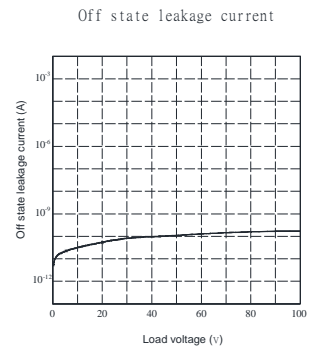
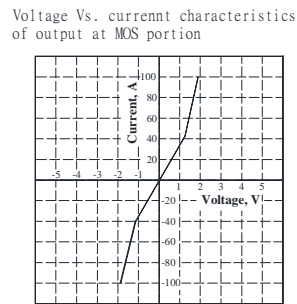
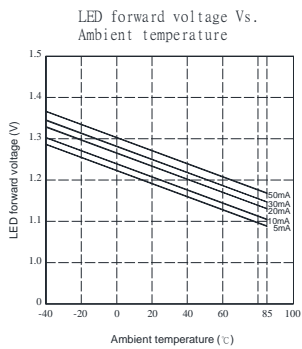
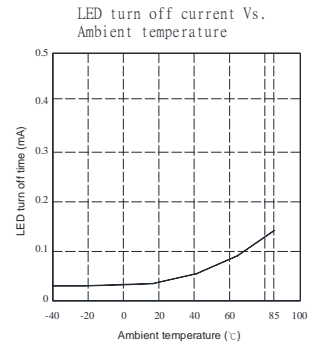
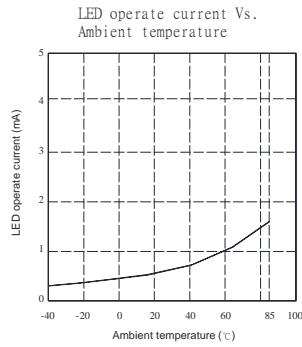
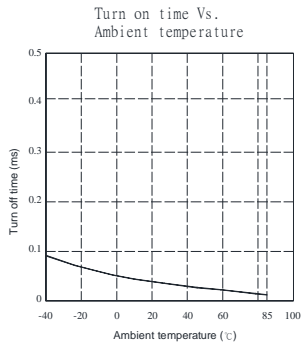
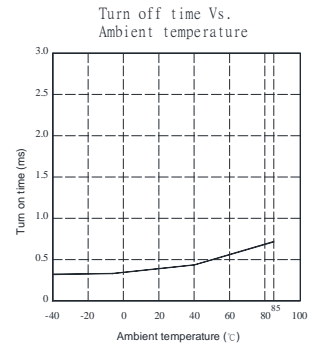
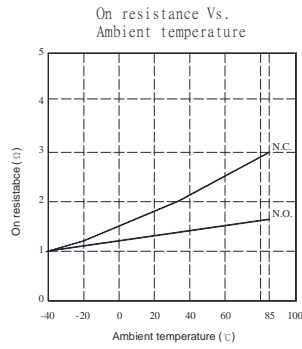
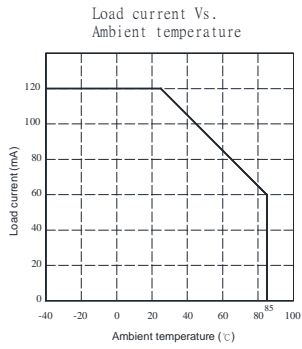

Dimensions

External dimensions

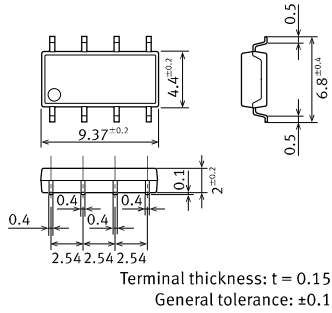

Marking

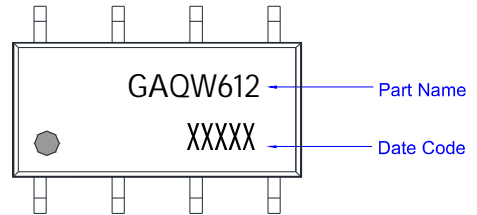

Recommended mounting pad (TOP VIEW)

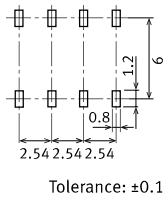

Tape dimensions

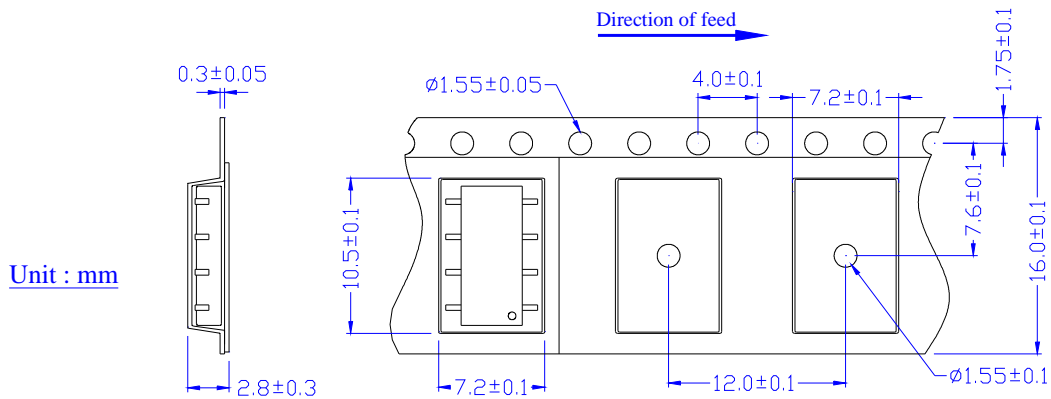

Dimensions of tape reel

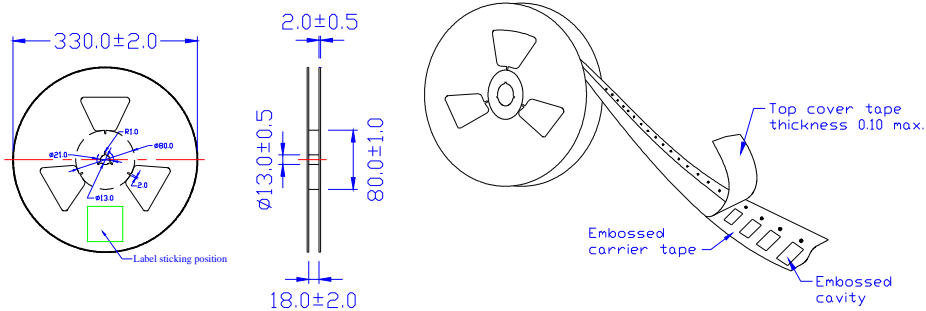

X-ON Electronics

Largest Supplier of Electrical and Electronic Components

Click to view similar products for [Solid State Relays - PCB Mount](#) category:

Click to view products by [SUPSiC](#) manufacturer:

Other Similar products are found below :

[M86F-2W](#) [M90F-2W](#) [M90F-2Y](#) [901-SX](#) [G2-1A07-ST](#) [G2-1A07-TT](#) [G2-1B02-TT](#) [G2-DA06-ST](#) [PLA134S](#) [DS11-1005](#) [AQH3213J](#)
[AQV112KLAXJ](#) [AQV210EHJ](#) [AQV212J](#) [AQV252GAJ](#) [AQY210ST](#) [AQY221N2SJ](#) [AQY221R2SJ](#) [EFR1200480A150](#) [901-7](#) [LCA220](#)
[LCB110S](#) [1618400-5](#) [SR75-1ST](#) [AQV112KLJ](#) [AQV212AJ](#) [AQV212SXJ](#) [AQV238AD01](#) [AQV252GAXJ](#) [AQW414TS](#) [AQY212ST](#)
[AQY221R2VJ](#) [AQY275AXJ](#) [AQY414SXE01](#) [G2-1A02-ST](#) [G2-1A03-ST](#) [G2-1A03-TT](#) [G2-1A05-ST](#) [G2-1A06-TT](#) [G2-1A23-TT](#) [G2-1B01-](#)
[ST](#) [G2-1B01-TT](#) [G2-1B02-ST](#) [G2-DA03-ST](#) [G2-DA03-TT](#) [G2-DA06-TT](#) [3-1617776-2](#) [CTA2425](#) [LBA110S](#) [LBB110S](#)