

Features

- LowRon=0.13Ω(Typ.)
- Low-level off state leakage current of max. 1 μA
- Low driver power requirements (TTL/CMOS Compatible)
- High reliability
- Hi-A : Load Current = 1.3A
- No moving parts
- 1500Vrms Input/Output isolation
- Arc-Free with no snubbing circuits
- SOP package 4 Pin type in miniature design
(4.4×4.3×2.1mm / .173×.169×.083inch)
- The optically coupled input is controlled by a highly efficient GaAlAs infrared LED and MOS FETs on the output side.

Applications

- Telecommunications (PC, Electronic notepad)
- Measuring and Testing equipment
- Industrial control
- Security equipments
- High speed inspection machine



SOP-4

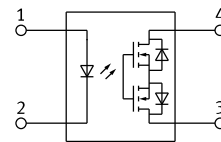

1. LED Anode
2. LED Cathode
- 3, 4. Drain (MOS FET)

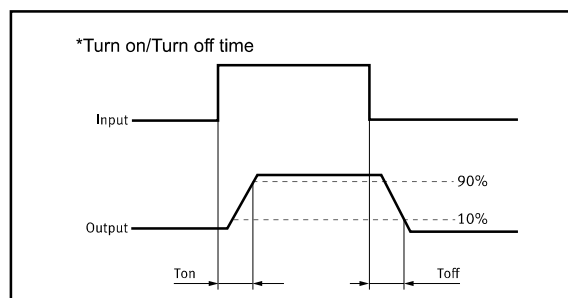

TYPES

Category	Output rating ^{*1}		Part No.	Packing quantity
	Load voltage	Load current		
AC/DC	60 V	1.3A	SOP-4 GAQY212G2S	Tape and reel 1-reel:1000pcs/2000pcs

Absolute Maximum Ratings (Ambient Temperature: 25°C)

	Item	Symbol	Value	Units	Note
Input	Continuous LED Current	I_F	50	mA	
	Peak LED Current	I_{FP}	1000	mA	f=100Hz, duty=1%
	LED Reverse Voltage	V_R	5	V	
	Input Power Dissipation	P_{In}	75	mW	
Output	Load Voltage	V_L	60	V(AC peak or DC)	
	Load Current	I_L	1.3	A	
	Peak Load Current	I_{Peak}	4.0	A	100ms(1 pulse)
	Output Power Dissipation	P_{out}	380	mW	
Total Power Dissipation		P_T	450	mW	
I/O Breakdown Voltage		$V_{I/O}$	1500	V _{rms}	RH=60%, 1min
Operating Temperature		T_{opr}	-40 to +85	°C	
Storage Temperature		T_{stg}	-40 to +100	°C	
Pin Soldering Temperature		T_{sol}	260	°C	10 sec max.

Electrical Specifications (Ambient Temperature: 25°C)

	Item	Symbol	MIN.	TYP.	MAX.	Units	Conditions
Input	LED Forward Voltage	V_F		1.2	1.4	V	$I_F=10mA$
	Operation LED Current	$I_{F on}$		0.5	2.0	mA	
	Recovery LED Current	$I_{F off}$		0.35	0.5	mA	
	Recovery LED Voltage	$V_{F off}$	0.7			V	
Output	On-Resistance	R_{on}		0.13	0.5	Ω	$I_F=5mA, I_L=100mA,$ Time to flow is within 1 sec.
	Off-State Leakage Current	I_{Leak}			1.0	μA	$V_L=Rating$
	Output Capacitance	C_{out}		115		pF	$V_L=0, f=1MHz$
Transmission	Turn-On Time	T_{on}		1.0	1.3	ms	$I_F=5mA, I_L=100mA,$
	Turn-Off Time	T_{off}		0.6	0.8	ms	
Coupled	I/O Isolation Resistance	$R_{I/O}$	10^{10}			Ω	DC500V
	I/O Capacitance	$C_{I/O}$		0.8	1.5	pF	f=1MHz

Reference Data

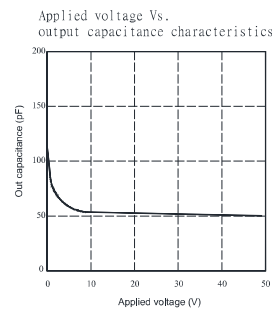
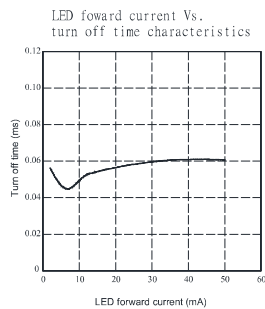
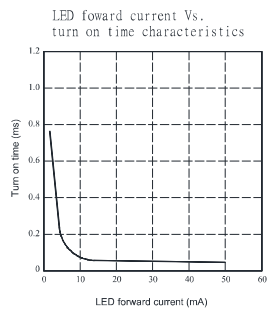
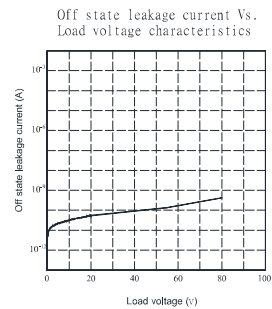
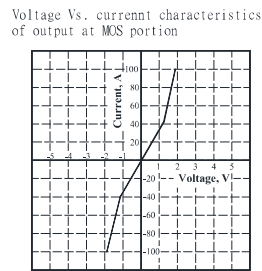
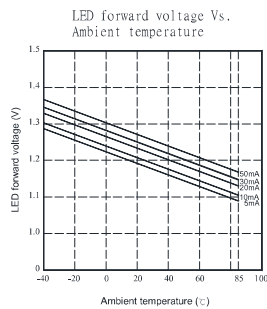
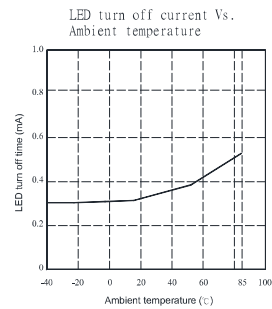
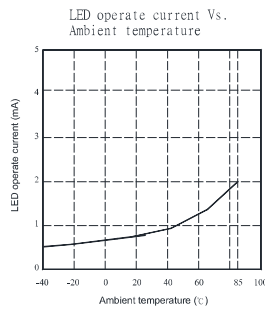
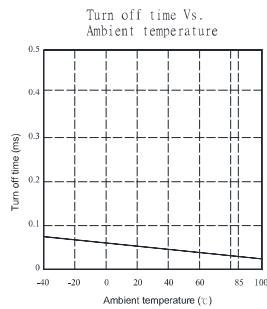
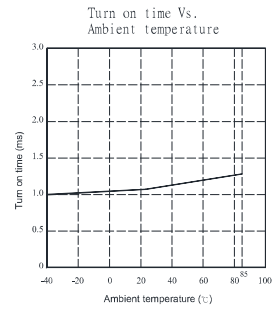
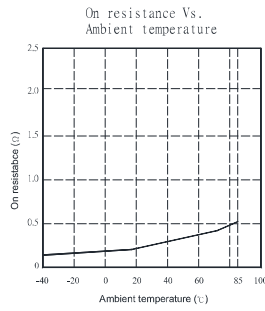
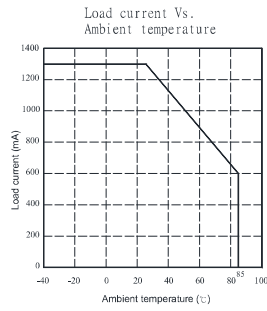

Dimensions

4-SOP

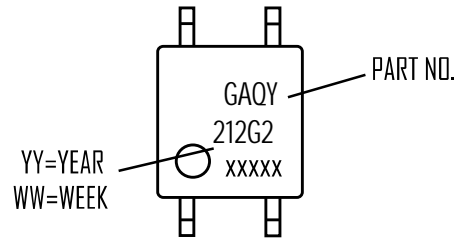

Surface mount terminal type

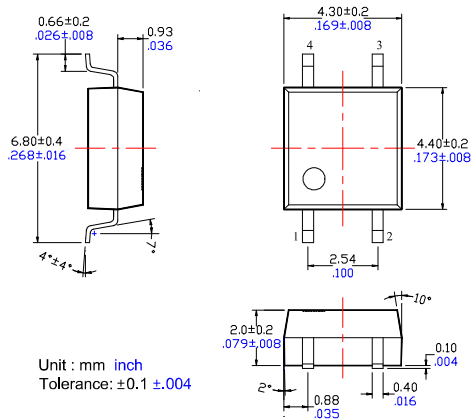

Recommended mounting pad (Top view)

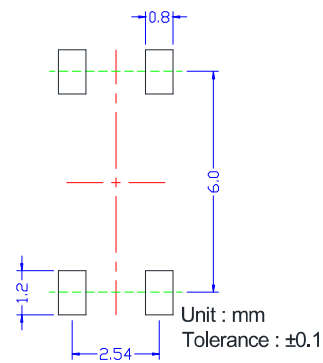

Tape dimensions

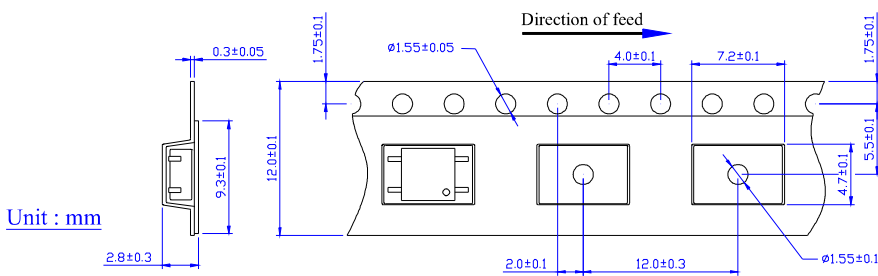

Dimensions of tape reel

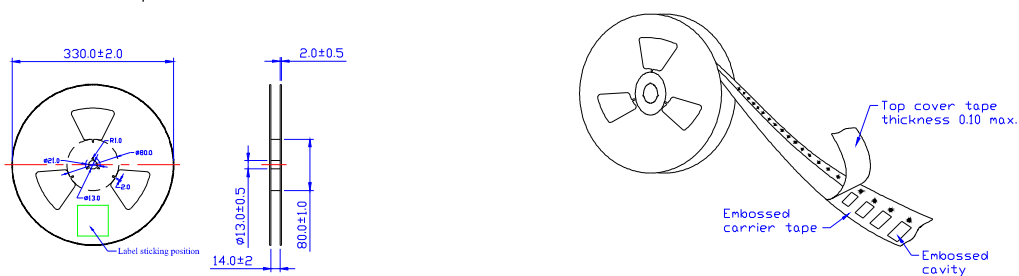

X-ON Electronics

Largest Supplier of Electrical and Electronic Components

Click to view similar products for [Solid State Relays - PCB Mount](#) category:

Click to view products by [SUPSiC](#) manufacturer:

Other Similar products are found below :

[M86F-2W](#) [M90F-2W](#) [M90F-2Y](#) [901-SX](#) [G2-1A07-ST](#) [G2-1A07-TT](#) [G2-1B02-TT](#) [G2-DA06-ST](#) [PLA134S](#) [DS11-1005](#) [AQH3213J](#)
[AQV112KLAXJ](#) [AQV210EHJ](#) [AQV212J](#) [AQV252GAJ](#) [AQY210ST](#) [AQY221N2SJ](#) [AQY221R2SJ](#) [EFR1200480A150](#) [901-7](#) [LCA220](#)
[LCB110S](#) [1618400-5](#) [SR75-1ST](#) [AQV112KLJ](#) [AQV212AJ](#) [AQV212SXJ](#) [AQV238AD01](#) [AQV252GAXJ](#) [AQW414TS](#) [AQY212ST](#)
[AQY221R2VJ](#) [AQY275AXJ](#) [AQY414SXE01](#) [G2-1A02-ST](#) [G2-1A03-ST](#) [G2-1A03-TT](#) [G2-1A05-ST](#) [G2-1A06-TT](#) [G2-1A23-TT](#) [G2-1B01-](#)
[ST](#) [G2-1B01-TT](#) [G2-1B02-ST](#) [G2-DA03-ST](#) [G2-DA03-TT](#) [G2-DA06-TT](#) [3-1617776-2](#) [CTA2425](#) [LBA110S](#) [LBB110S](#)